



PATENT- OG VAREMÆRKESTYRELSEN

Dansk Design- tidende

Indholdsfortegnelse

Designsager

Offentliggørelse af designregistreringer	26
Henlagte, afslåede eller tilbagetagne designansøgninger	29
Ændringer til design	30
Fornyelse af designregistreringer	31
Offentliggørelse af internationale designregistreringer	32

Mønstersager

Ændringer til mønstre	78
-----------------------------	----

Dansk Designtidende kan rekvireres som papirkopi for kr. 150 stk. på tlf. 43 50 85 35

Ansvarlig for redaktion: Keld Nymann Jensen
Udgives af Patent- og Varemærkestyrelsen, Helgeshøj Allé 81, 2630 Tåstrup, tlf. 43 50 80 00

ISSN 1601-7374

Design

Offentliggørelse af designregistreringer

Enhver kan anmode om hel- eller delvis udslettelse af en registrering (administrativ prøvning), jf. § 25 i designlov nr. 1259 af 20. december 2000. En model af designet kan ses i Patent- og Varemærkestyrelsen, hvis det er offentliggjort, at en model er indleveret til styrelsen. Det er anført, hvis et design er registreret i farve.

(11) DR 2012 00003
(21) DA 2012 00007

(54) Foldbar kuffert til dyretransport

(51)-Cl.09 03;30 99

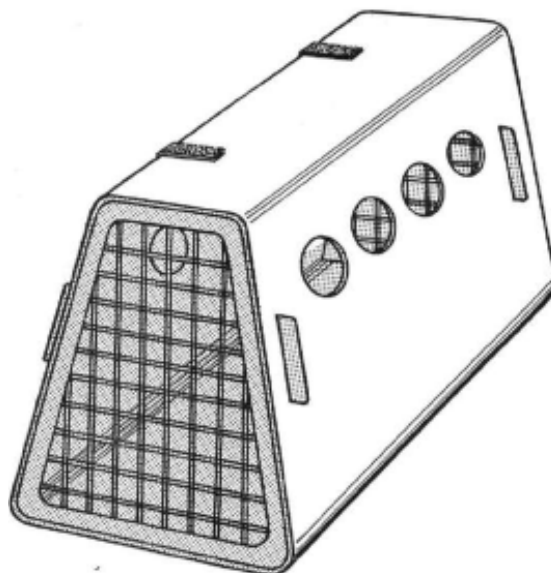
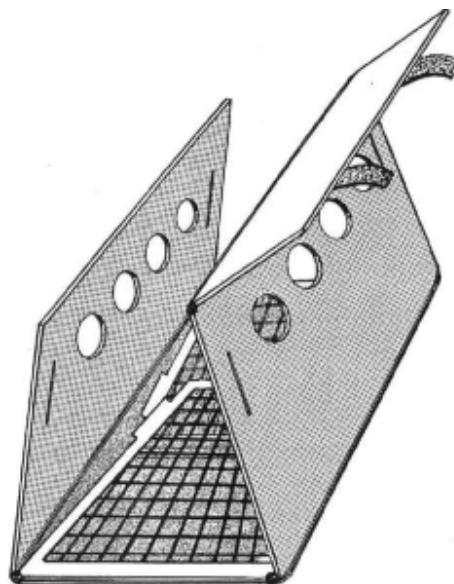
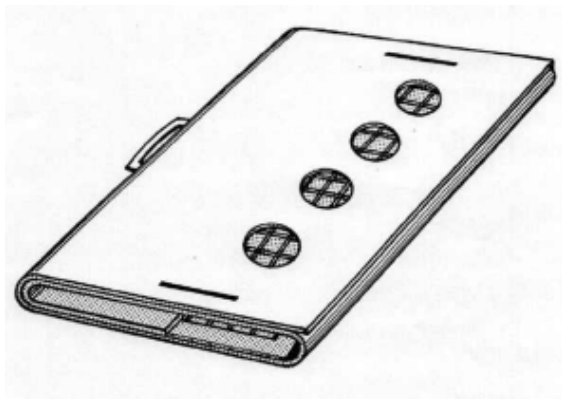

(71) ANSØGER(E):
(72) FREMBRINGER(E):
(22) ANSØGNINGSDATO:
(18) GYLDIG TIL:

Borggaard I/S v/ Susanne & René Borggaard, Saltofte Holme 12, 4295 Stenlille, Danmark
Rene Bennet Borggaard, Saltofte Holme 12, 4295 Stenlille, Danmark
2012-01-17
2017-01-17

(11) DR 2012 00004
(21) DA 2011 00126

(54) En hermestisk 1.cylinder CO2 kompressor med variabel omløbstal

(51)-Cl.15 02

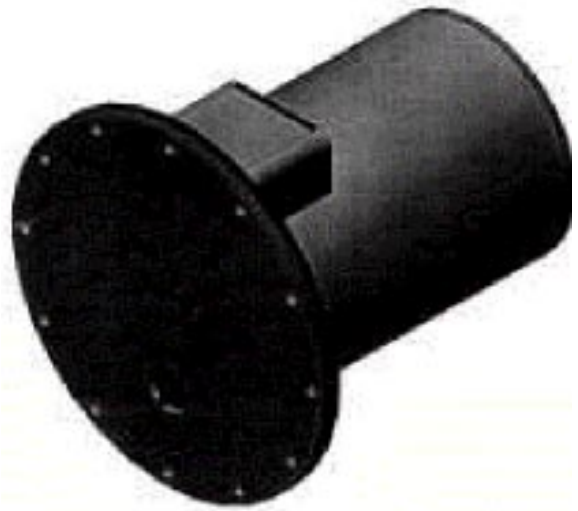
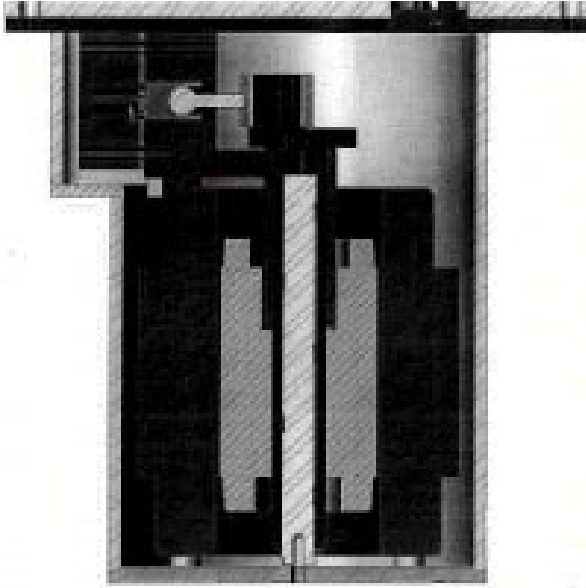

(71) ANSØGER(E): Harry Stentoft Nissen, Stenbjergparken 4 A, 6400 Sønderborg, Danmark
Egon Sveistrup, Irmingersvej 14, 6400 Sønderborg, Danmark
(72) FREMBRINGER(E): Harry Stentoft Nissen, Stenbjergparken 4 A, 6400 Sønderborg, Danmark
Egon Sveistrup, Irmingersvej 14, 6400 Sønderborg, Danmark
(22) ANSØGNINGSDATO: 2011-10-19
(18) GYLDIG TIL: 2016-10-19

(11) DR 2012 00005
(21) DA 2011 00110

(54) En holder til tablets (computere)

(51)-Cl.14 99

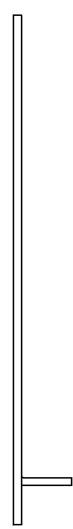
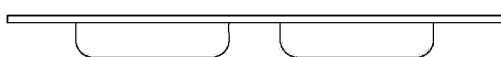
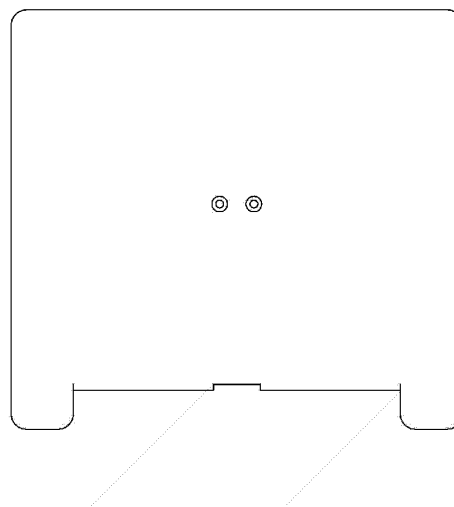
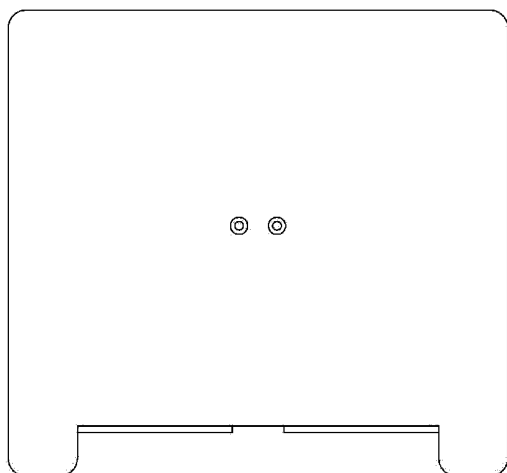

(71) ANSØGER(E):
(22) ANSØGNINGSDATO:
(18) GYLDIG TIL:

Per Raanes Hansen, Mejsevænget 8, st.tv., 2400 København NV, Danmark
2011-08-31
2016-08-31

Henlagte, afslåede eller tilbagetagne designansøgninger

Henlagte, afslåede eller tilbagetagne designansøgninger, som er offentligt tilgængelige.

(21) Ansøgningsnummer

(43) Offentliggjort i tidende

DA 2011 00121

Ændringer

Ændringer vedrørende retten til designet, indehaverens navn/firma og adresse, fuldmægtig m.v.

Overdragelser:

(11) DR 2006 00261

Til: (71) OFFPISTE ApS, Bøgeskovvej 18A, 3490 Kvistgård, Danmark

Fornyelse af designregistreringer

Fornyelse af registreringer foretaget i medfør af § 23, stk. 1, i designlov nr. 1259 af 20. december 2000.

(11) Registreringsnummer	(18) Gyldig til
DR 2007 00067	20170130
DR 2002 00527	20170214
DR 2007 00166	20170213
DR 2002 00581	20170308
DR 2002 00082	20170208
DR 2002 00232	20170208
DR 2002 00299	20170313
DR 2002 00106	20170220
DR 2006 00261	20161221
DR 2001 00077	20161109
DR 2001 00078	20161109
DR 2002 00372	20161121

Offentliggørelse af internationale designregistreringer

Enhver kan anmode om hel eller delvis udslættelse (administrativ prøvning) af en international registrering, jf. designlovens § 54, jf. § 25. En model af designet kan ses i Patent- og Varemærkestyrelsen, hvis det er offentliggjort, at en model er indleveret i styrelsen. Det er anført, hvis et design er registreret i farve.

(11) Reg. nr.:

GD72681

(54) Vareangivelse:

Packaging for liquids and viscous products

(51) Cl.:

09 05

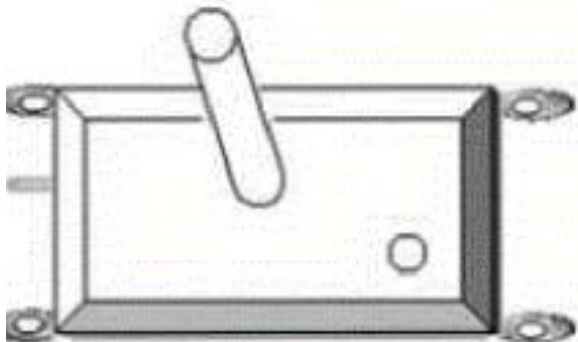

(71) Indehaver:

RUDIGER CRUYSBERGHS, Haachtsesteenweg 1369, B-1130 BRUSSELS (HAREN), Belgien

(72) Designer:

(80) Designeringsdato:

2009-11-23

(80) International registreringsdato: 2009-11-23

(11) Reg. nr.:
(54) Vareangivelse:
(51) Cl.:

GD72724
Structure for car washing
25 03

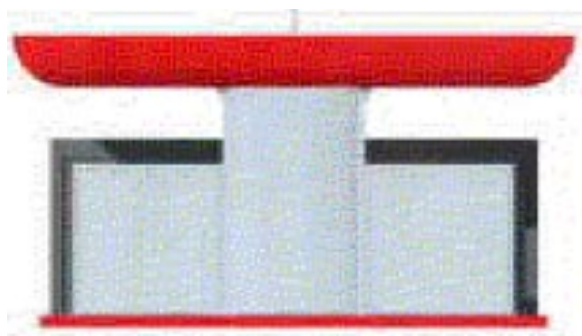
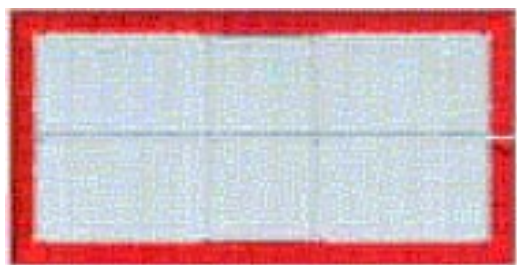

(71) Indehaver: ADRIATEH D.O.O., Dr. Franje Tudmana 26, HR-10431 Sveta Nedelja, Novaki, Kroatien
(72) Designer: GORAN REBIC, Kraljice Jelene 6, Samobor, Kroatien
(80) Designeringsdato: 2009-12-09
(80) International registreringsdato: 2009-12-09

(11) Reg. nr.:
(54) Vareangivelse:
(51) Cl.:

GD72929
Electrically driven low floor minibus chassis
12 08

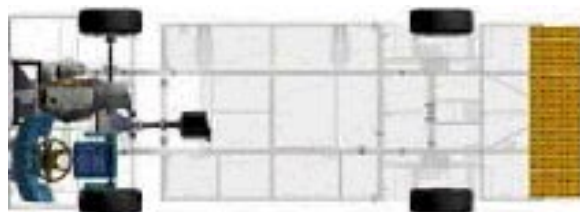
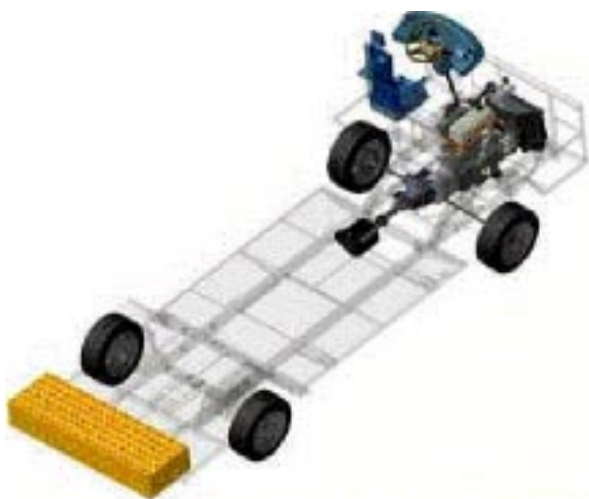

(71) Indehaver: ZIVKO ILIJEVSKI, Tina Ujevica 16, HR-10434 STRMEC SAMOBORSKI, Kroatien
(72) Designer:
(80) Designeringsdato: 2009-10-13
(80) International registreringsdato: 2009-10-13

(11) Reg. nr.:

GD73028

(54) Vareangivelse:

Seat consisting of two circular tubes with a different diameter and perimeter, the smaller tube lays within the larger tube and is adjacent, both tubes have an opening at the same side
06 01

(51) Cl.:



(71) Indehaver:

Carl Mariën, Bergstraat 30, B-1982 Weerde, Belgien

(72) Designer:

(30) Prioritetsoplysninger:

2009-08-11 BX 83180

(80) Designeringsdato:

2010-02-04

(80) International registreringsdato: 2010-02-04

(11) Reg. nr.:

(54) Vareangivelse:

GD73504

1) Hood for Motor Vehicles, 2-3) Trunk Lids for Motor Vehicles, 4) Front Bumper for Motor Vehicles, 5) Rear Bumper for Motor Vehicles, 6) Front Door for Motor Vehicles, 7) Rear Door for Motor Vehicles, 8) Door for Motor Vehicles, 9) Front Fender for Motor Vehicles, 10) Decorative element for Motor Vehicles
12 16

(51) Cl.:

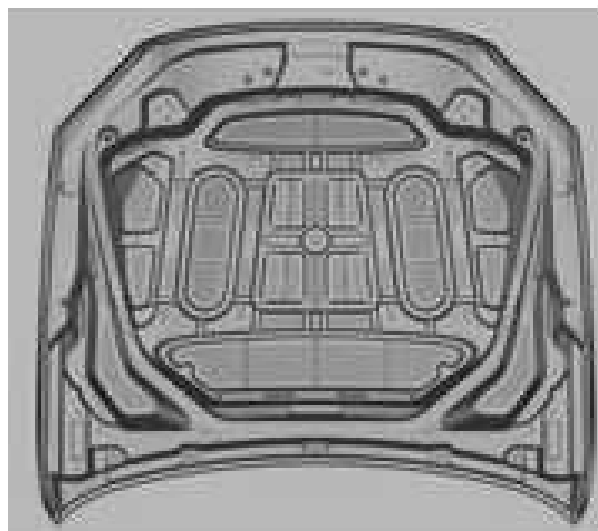
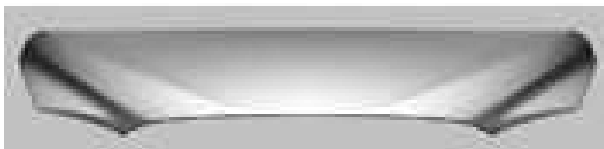
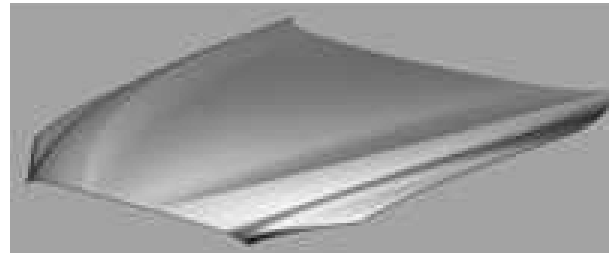
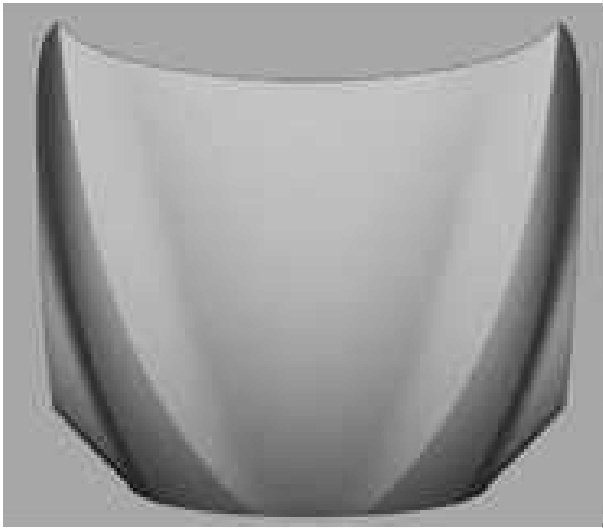

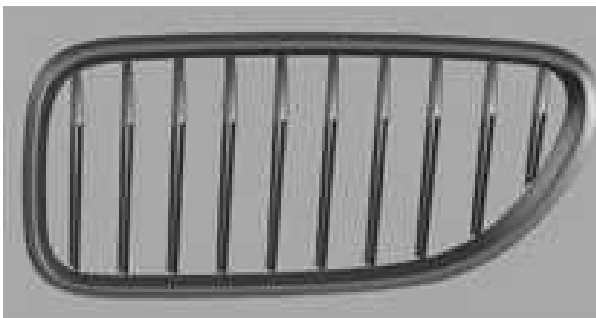
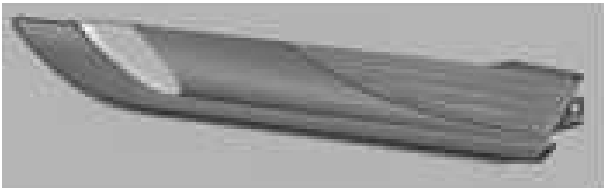
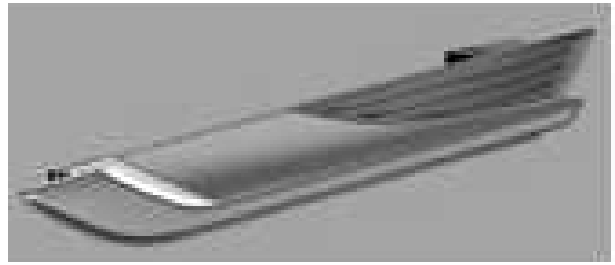
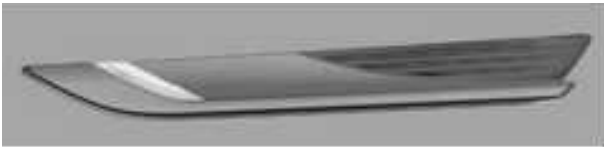

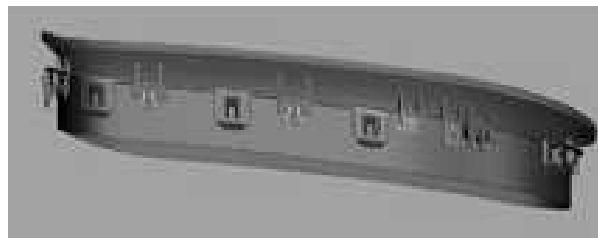
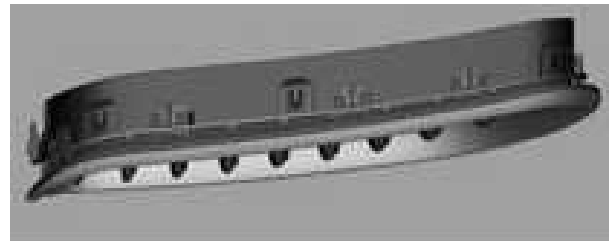

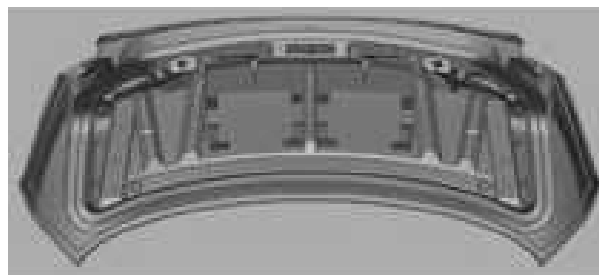
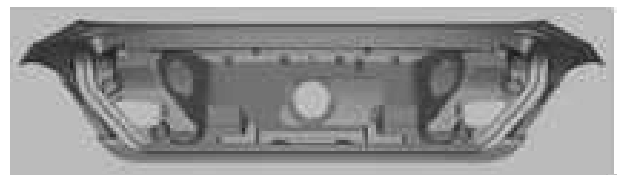
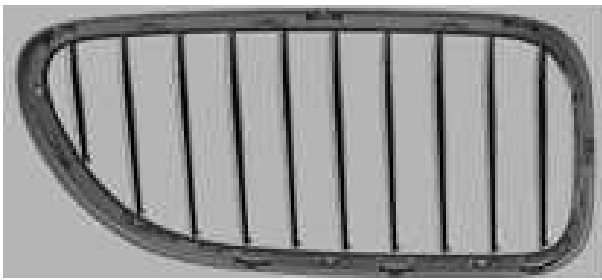

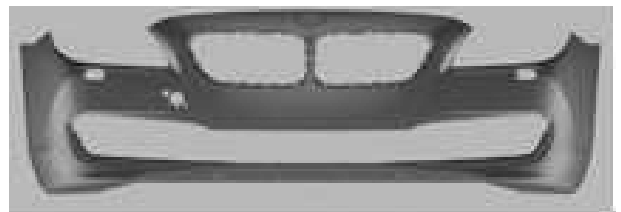

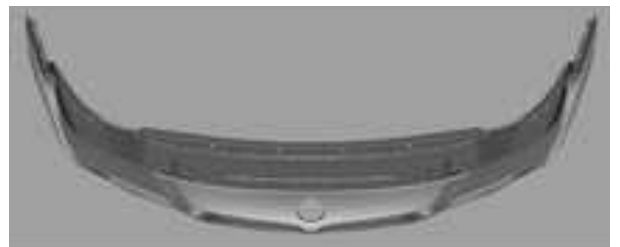

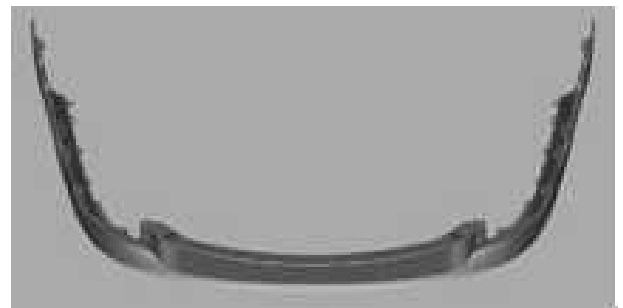
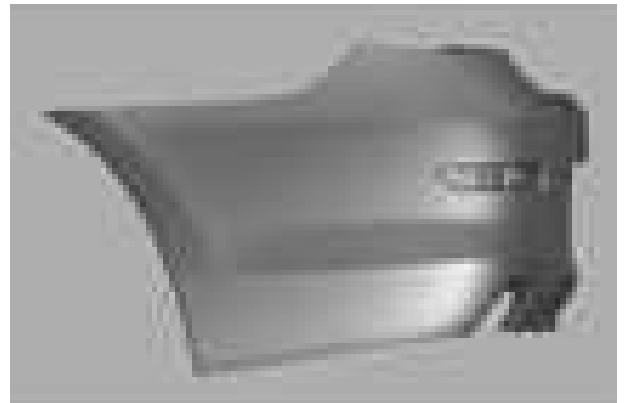
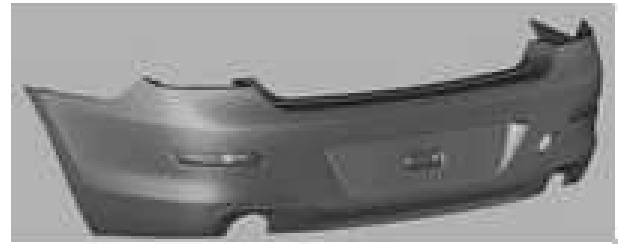

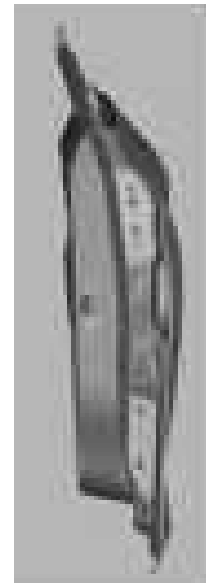
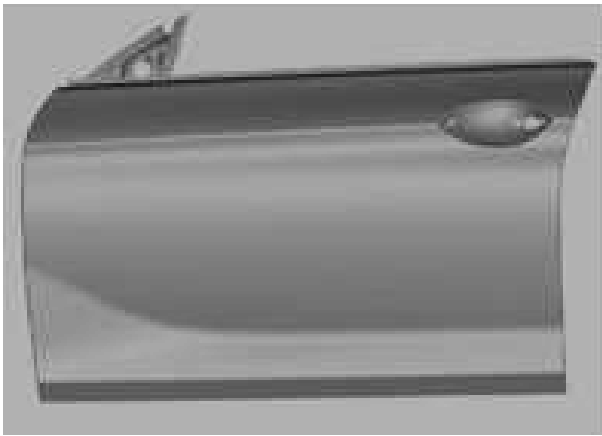

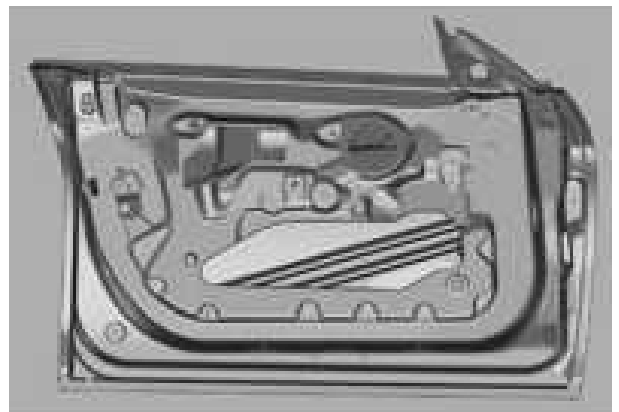
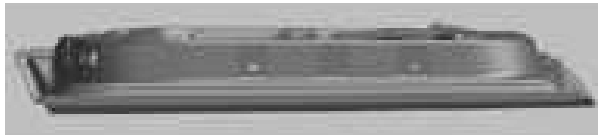
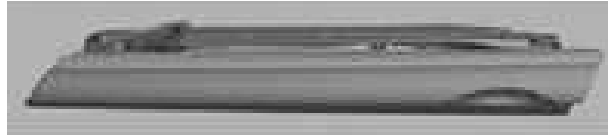
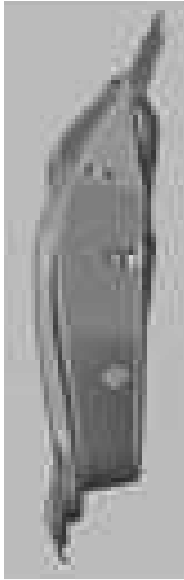

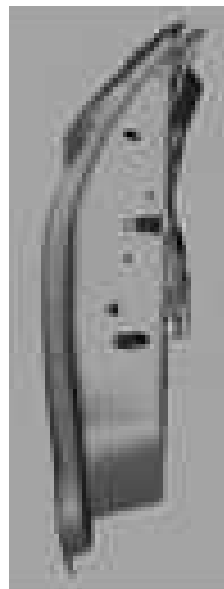
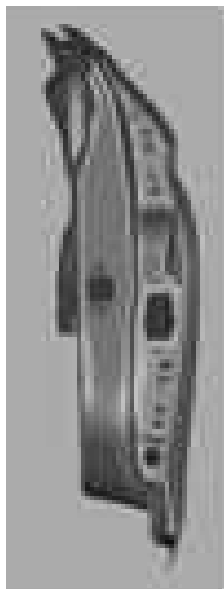
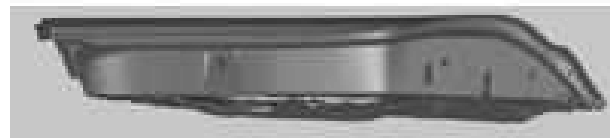
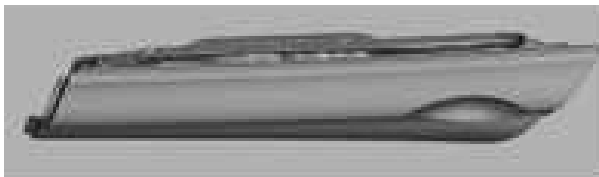
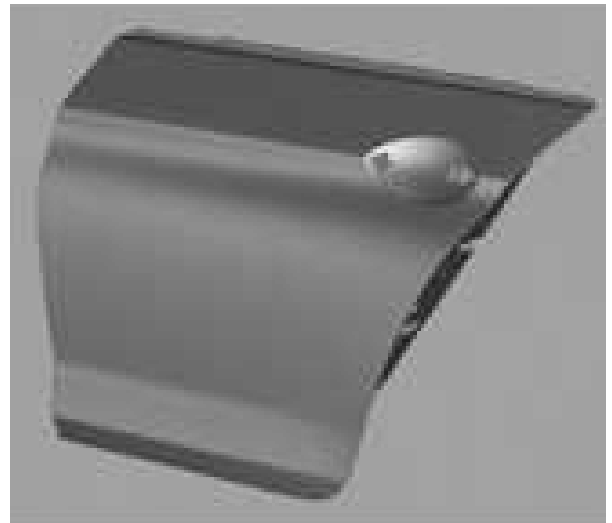

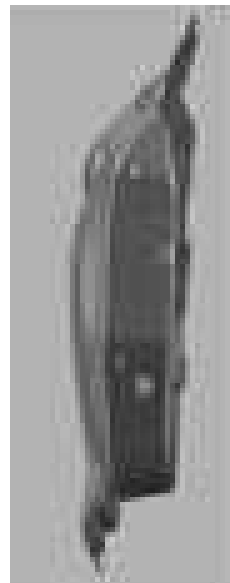
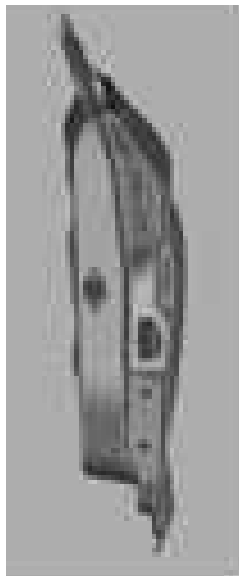
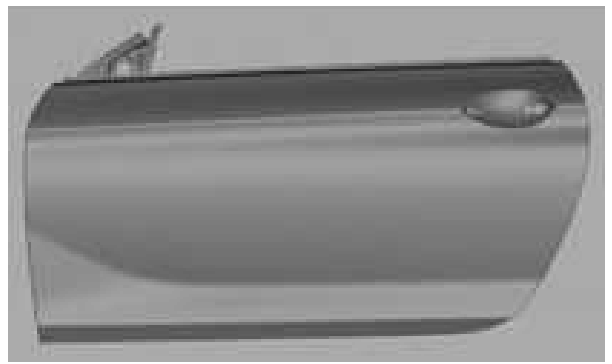

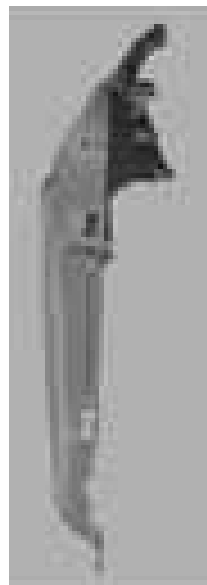
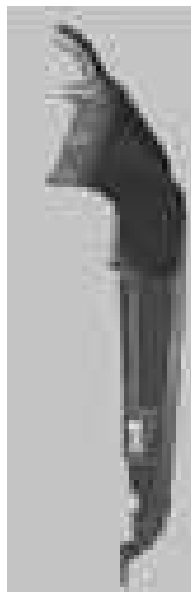
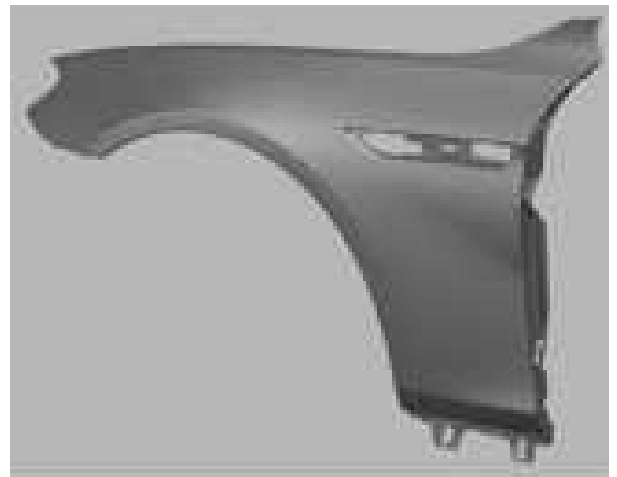
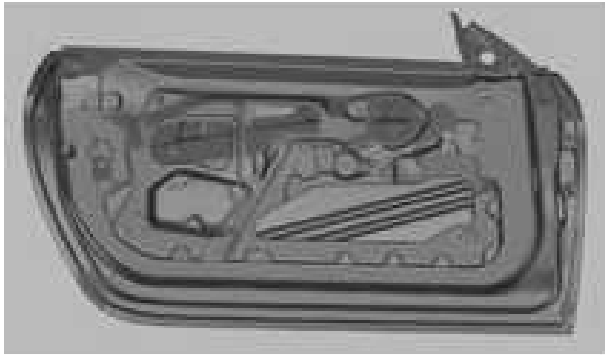
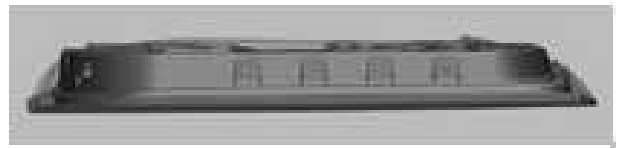
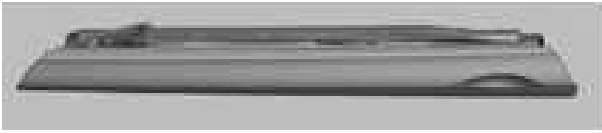



(71) Indehaver: BAYERISCHE MOTOREN WERKE AKTIENGESELLSCHAFT, Petuelring 130, 80809 München, Tyskland
(72) Designer:
(80) Designeringsdato: 2010-04-22
(80) International registreringsdato: 2010-04-22

(11) Reg. nr.: **GD73714**
(54) Vareangivelse: Adapter for a dental apparatus for water and air
(51) Cl.: 24 01

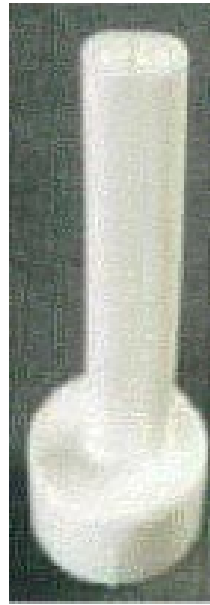
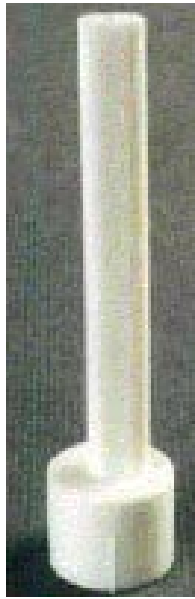

(71) Indehaver: GORAN MILANOVIC, Krusedolska 15, 11351 Vinca, Serbien
(72) Designer:
(30) Prioritetsoplysninger: 2010-03-19 RS D-0018/2010
(80) Designeringsdato: 2010-05-21
(80) International registreringsdato: 2010-05-21

(11) Reg. nr.:
(54) Vareangivelse:
(51) Cl.:

GD73872
Front bumpers for motor vehicles
12 16



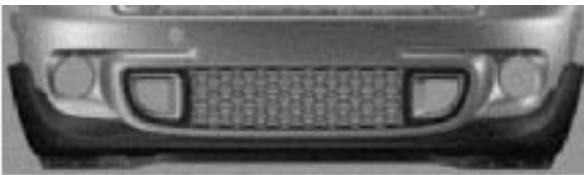
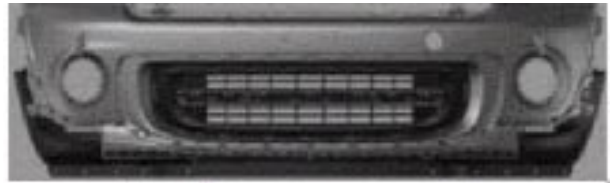



- (71) Indehaver: Bayerische Motoren Werke Aktiengesellschaft, Petuelring 130, D-80809 München, Tyskland
(72) Designer:
(80) Designeringsdato: 2010-06-28
(80) International registreringsdato: 2010-06-28
-

(11) Reg. nr.:
(54) Vareangivelse:
(51) Cl.:

GD74537
Flying apparatus
12 07





- (71) Indehaver: LECOULTE ANDRÉ, Le Pâquis 2, CH-1521 Curtilles, Schweiz
(72) Designer:
(74) International fuldmægtig: Cabinet Roland Nithardt, Conseils en Propriété Industrielle SA Y-Parc, Rue Galilée 9, CH-1400 Yverdon-les-Bains, Schweiz
(30) Prioritetsoplysninger: 2010-04-06 CH 136 924
(80) Designeringsdato: 2010-10-05
(80) International registreringsdato: 2010-10-05
-

(11) Reg. nr.:
(54) Vareangivelse:
(51) Cl.:

GD74766
1-2) Headlights for Motor Vehicles; 3-4) Rear Lights for Motor Vehicles
26 06

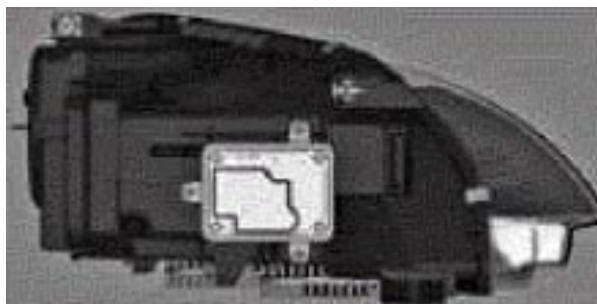

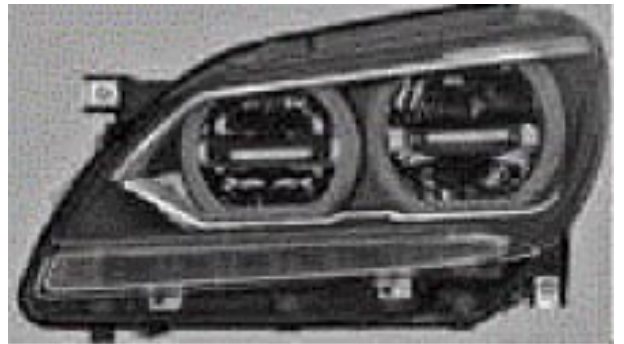
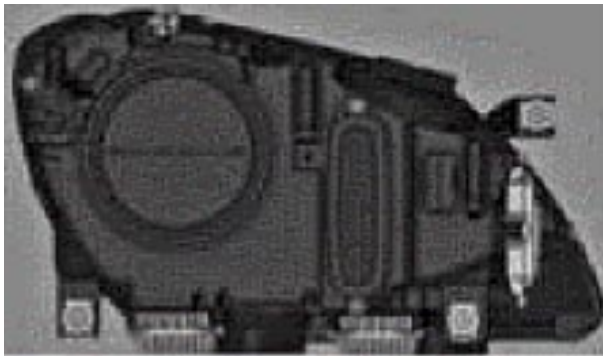
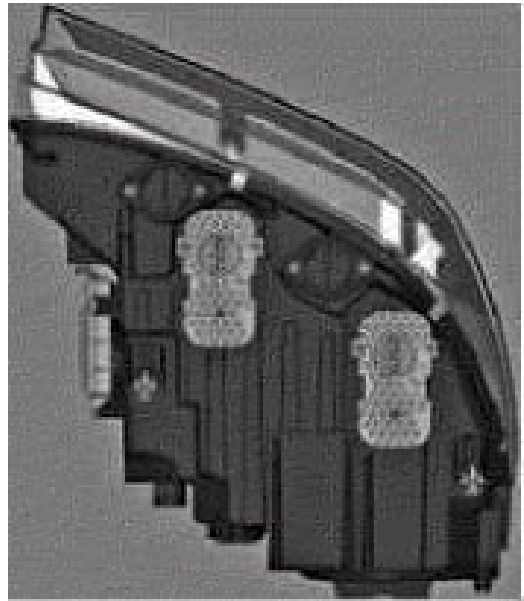

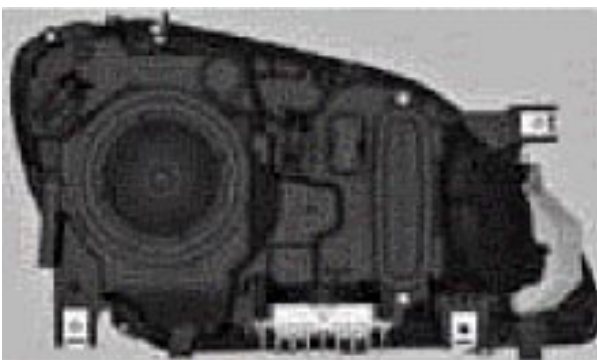
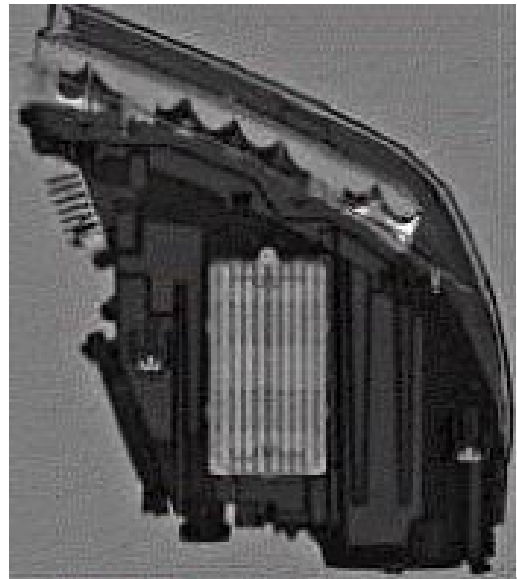
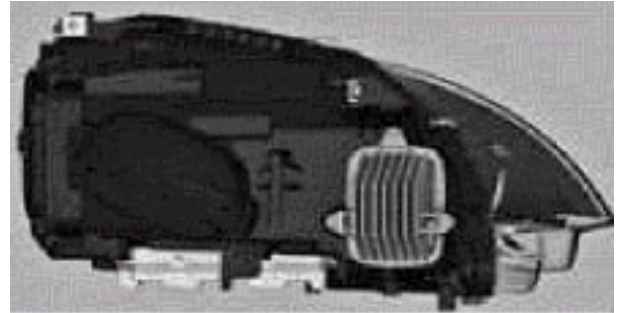

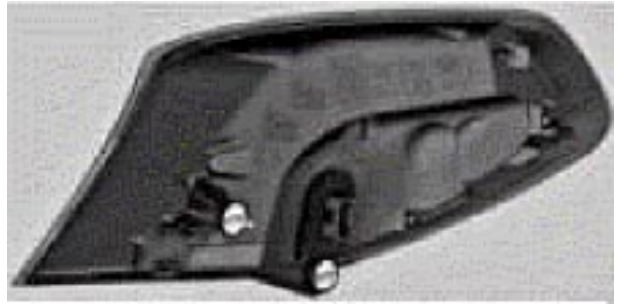
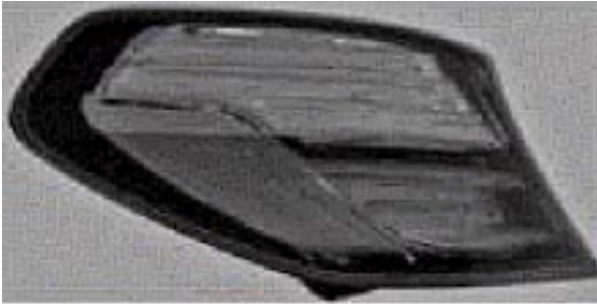

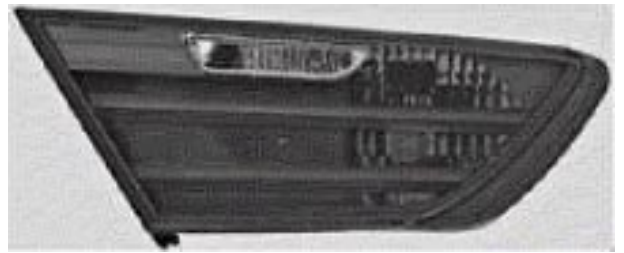

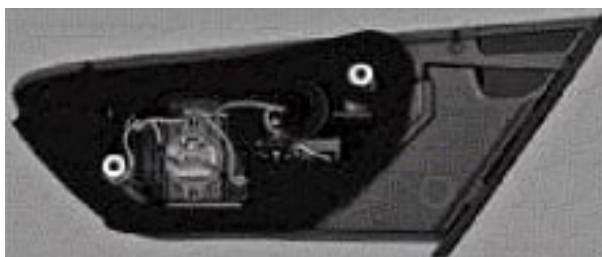
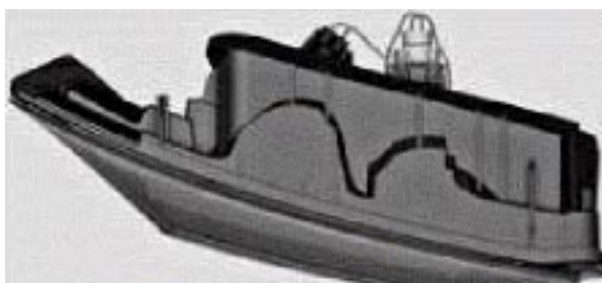

(71) Indehaver: BAYERISCHE MOTOREN WERKE AKTIENGESELLSCHAFT, Petuelring 130, 80809 München, Tyskland
(72) Designer:
(80) Designeringsdato: 2010-11-17
(80) International registreringsdato: 2010-11-17

(11) Reg. nr.: **GD74771**
(54) Vareangivelse: Sticker
(51) Cl.: 19 08



(71) Indehaver: KAOCI COATINGS (MOHAMED MOHAMED AHMED ELSAYED & PARTNERS), Port Said Governorate
Industrial Zone, ElRaswa, Port Said, Egypten
(72) Designer:
(74) International fuldmægtig: Hatem Talat Abbass, PO Box 118, Port Said, Egypten
(80) Designeringsdato: 2009-11-16
(80) International registreringsdato: 2009-11-16

(11) Reg. nr.:
(54) Vareangivelse:
(51) Cl.:

GD74880
Billiard table
06 03

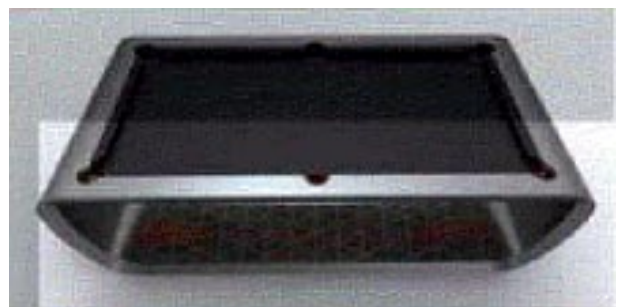

(71) Indehaver: Billards Toulet, 600 avenue du Général de Gaulle, F-59910 Bondues, Frankrig
(72) Designer:
(80) Designeringsdato: 2010-04-01
(80) International registreringsdato: 2010-04-01

(11) Reg. nr.:
(54) Vareangivelse:
(51) Cl.:

GD74972
1) Rear Light for Motor Vehicles
26 06



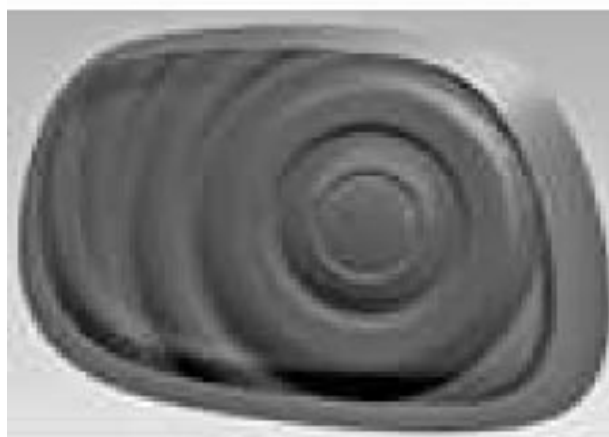

(71) Indehaver: BAYERISCHE MOTOREN WERKE AKTIENGESELLSCHAFT, Petuelring 130, 80809 München, Tyskland
(72) Designer:
(80) Designeringsdato: 2010-12-13
(80) International registreringsdato: 2010-12-13

(11) Reg. nr.:
(54) Vareangivelse:
(51) Cl.:

GD75065
Furniture design with a circular structure connecting two seats allowing two people to sit face to face
06 01

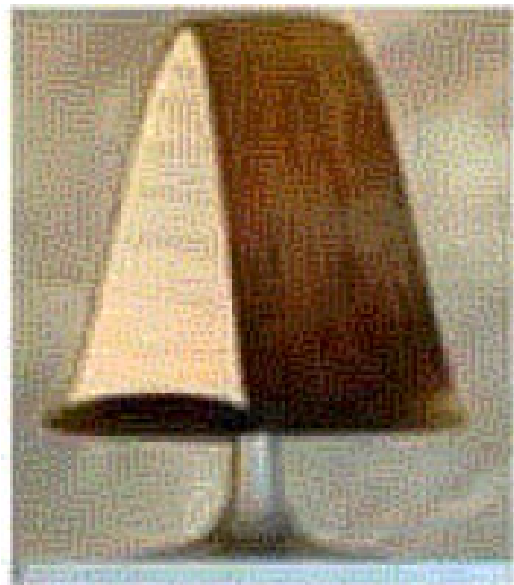
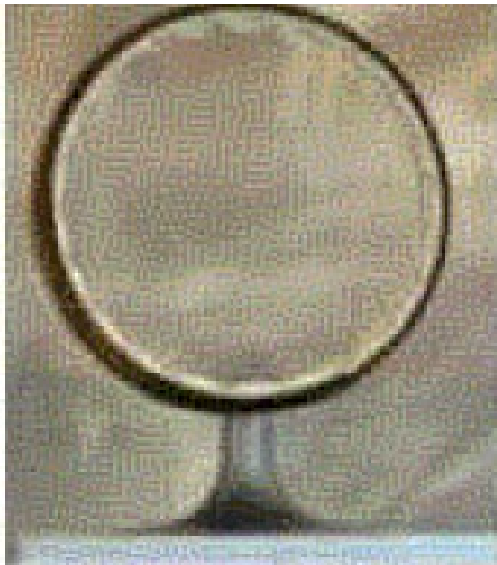

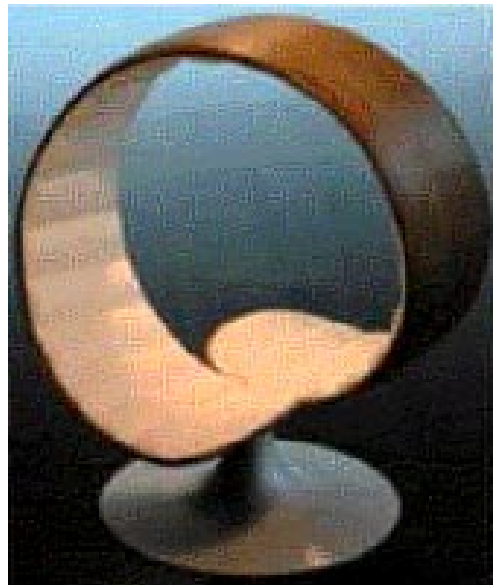
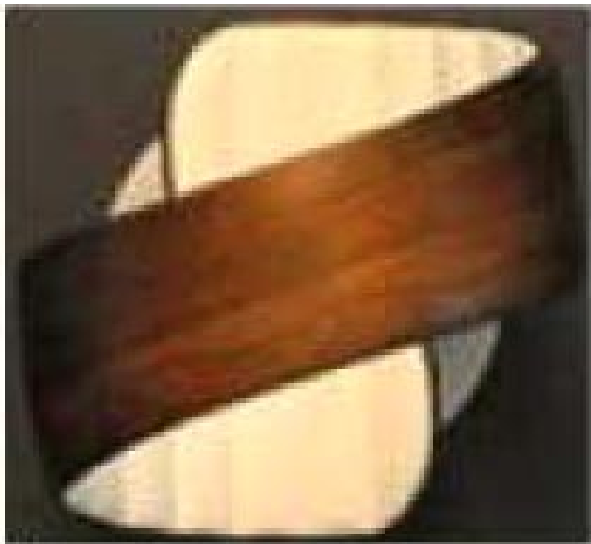

- (71) Indehaver: Esch & Kramer, Speditionsstrasse 17, D-40221 Düsseldorf, Tyskland
(72) Designer:
(74) International fuldmægtig: Esch & Kramer, Speditionsstrasse 17, D-40221 Düsseldorf, Tyskland
(80) Designeringsdato: 2010-12-13
(80) International registreringsdato: 2010-12-13

(11) Reg. nr.:
(54) Vareangivelse:
(51) Cl.:

GD75337
Fertilizer packaging
09 03

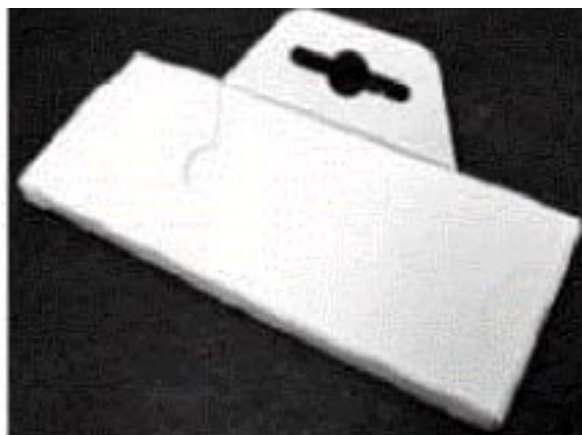
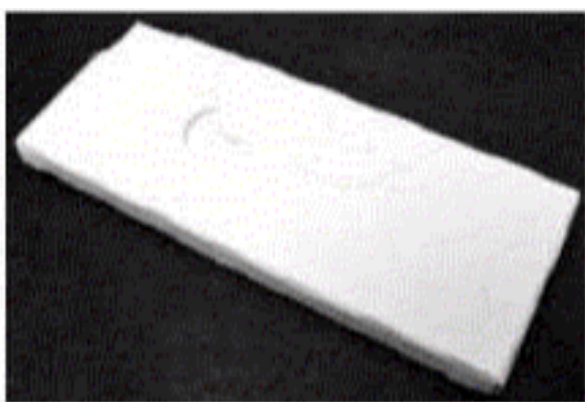
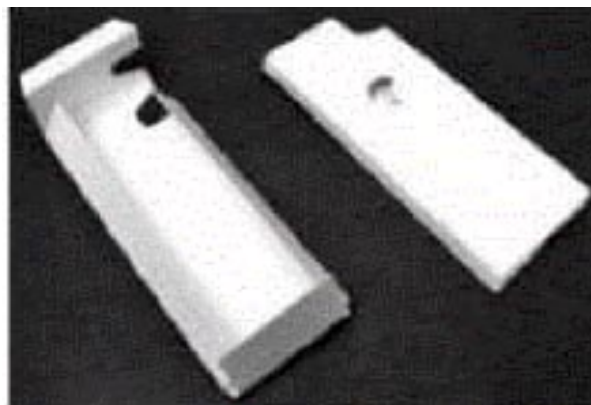
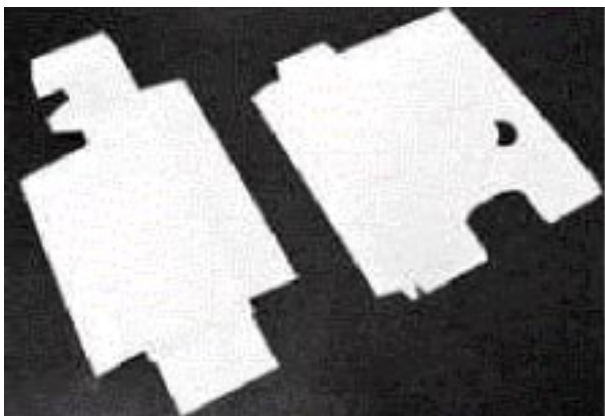

(71) Indehaver: Van Genechten Packaging, naamloze vennootschap, Raadsherenstraat 2, B-2300 Turnhout, Belgien
(72) Designer: Hannes De Winter, Sniederspad 27, NL-2980 Halle-Zoersel, Belgien
(74) International fuldmægtig: VAN GENECHTEN BIERMANS NV., Raadsherenstraat 2, B-2300 Turnhout, Belgien
(80) Designeringsdato: 2011-02-02
(80) International registreringsdato: 2011-02-02

(11) Reg. nr.:
(54) Vareangivelse:
(51) Cl.:

GD75433
Box for confectionery
09 03

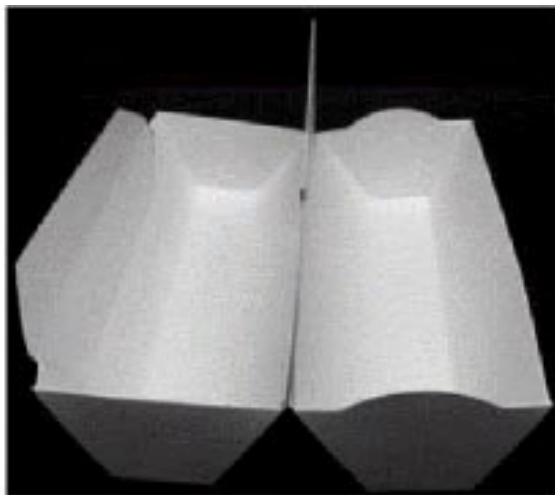
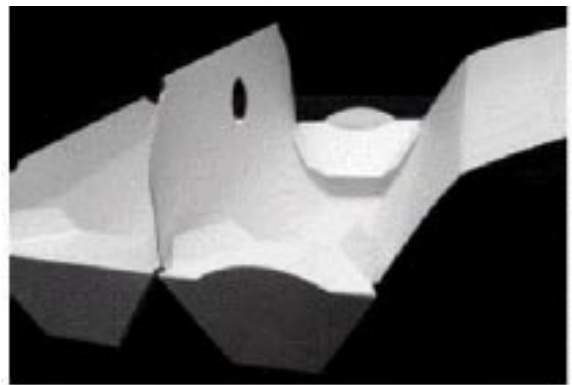
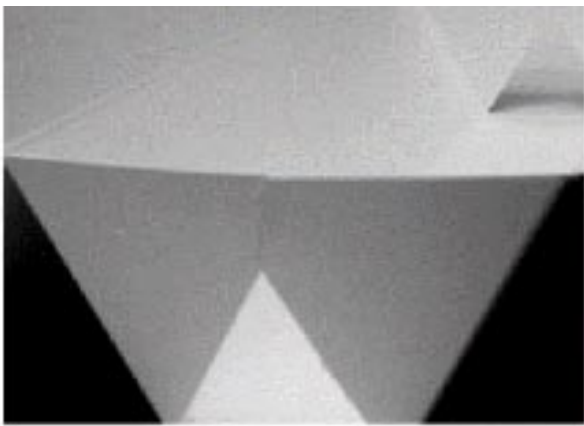
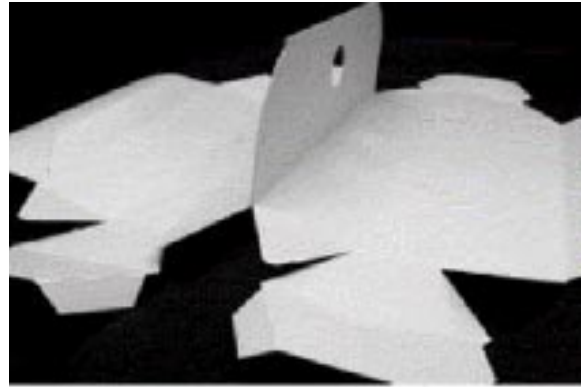
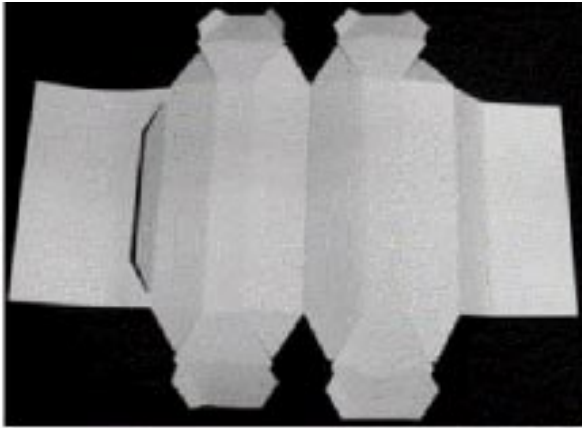

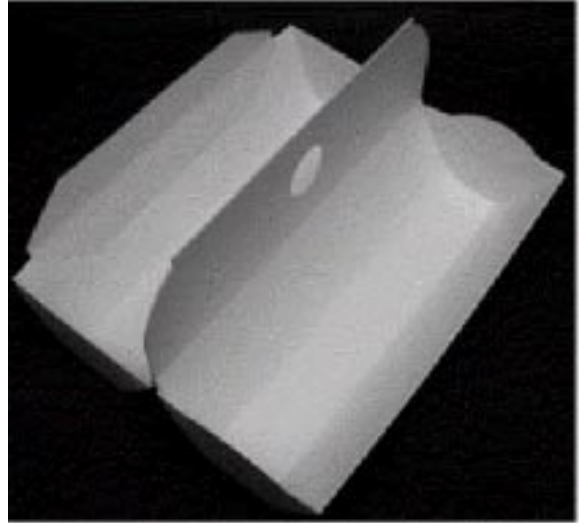
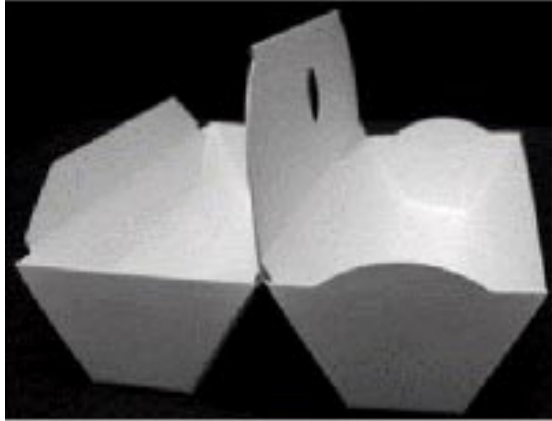

- (71) Indehaver: VAN GENECHTEN PACKAGING, Raadsherenstraat 2, B-2300 Turnhout, Holland
(72) Designer: Frank Baeten, Waleweinlaan 132, NL-5665 CL Geldrop, Holland
(80) Designeringsdato: 2011-01-17
(80) International registreringsdato: 2011-01-17
-

(11) Reg. nr.:
(54) Vareangivelse:
(51) Cl.:

GD75768
1-4) Bottels
09 01

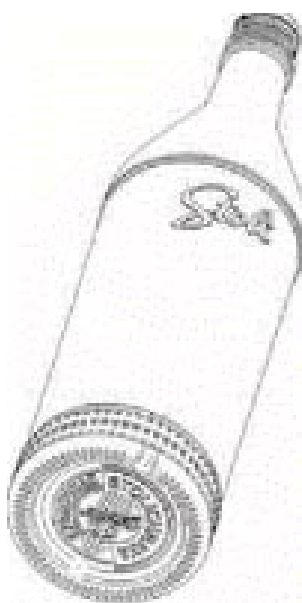



- (71) Indehaver: Spirits International B.V., 7, rue Nicolas Bové, L-1253 Luxembourg, Luxembourg
(72) Designer:
(30) Prioritetsoplysninger: 2010-12-28 CH 137594
(80) Designingsdato: 2011-04-04
(80) International registreringsdato: 2011-04-04

(11) Reg. nr.:
(54) Vareangivelse:
(51) Cl.:

GD75779
1-4)Lightning apparatus
26 05

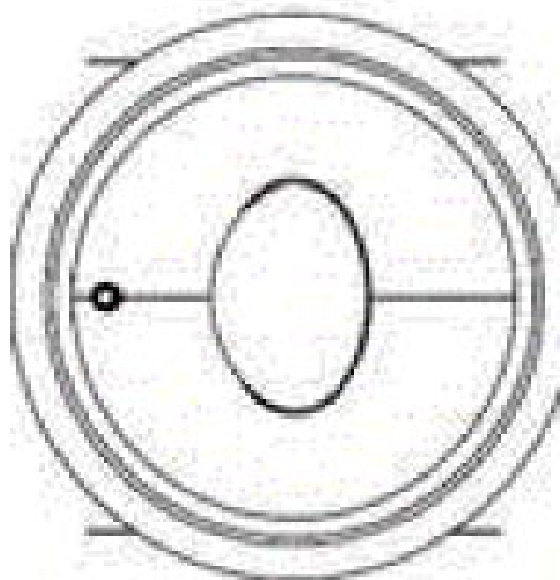
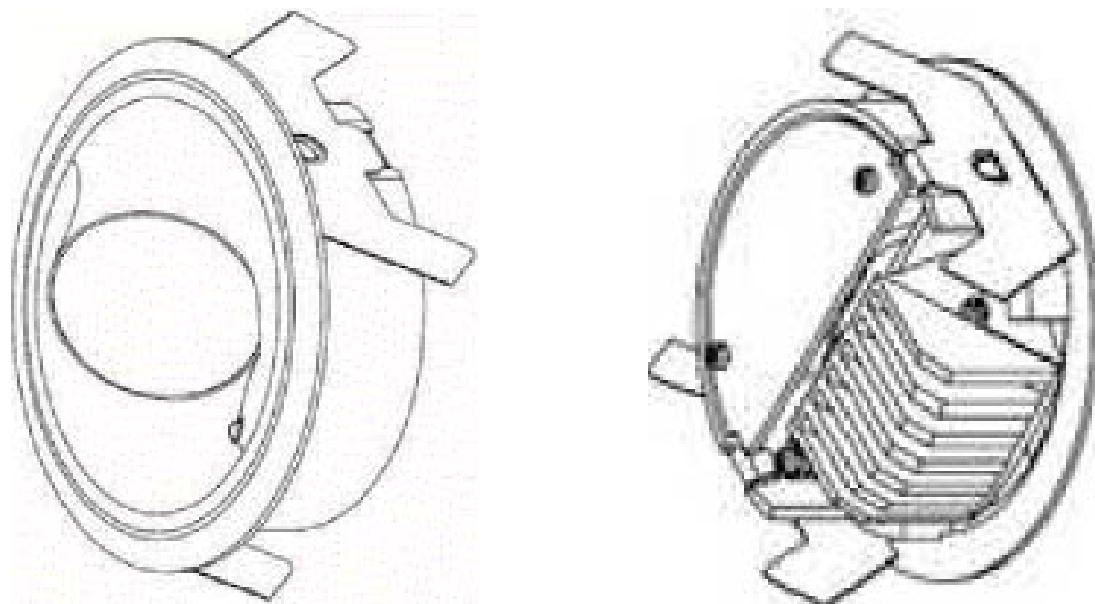

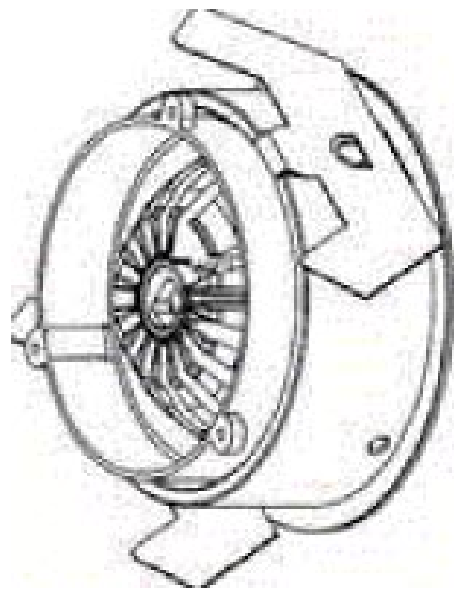
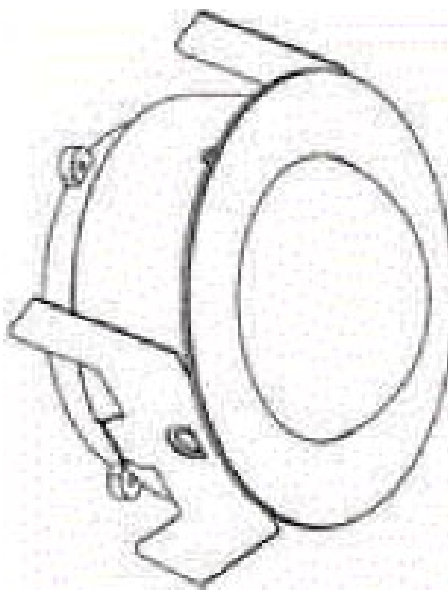
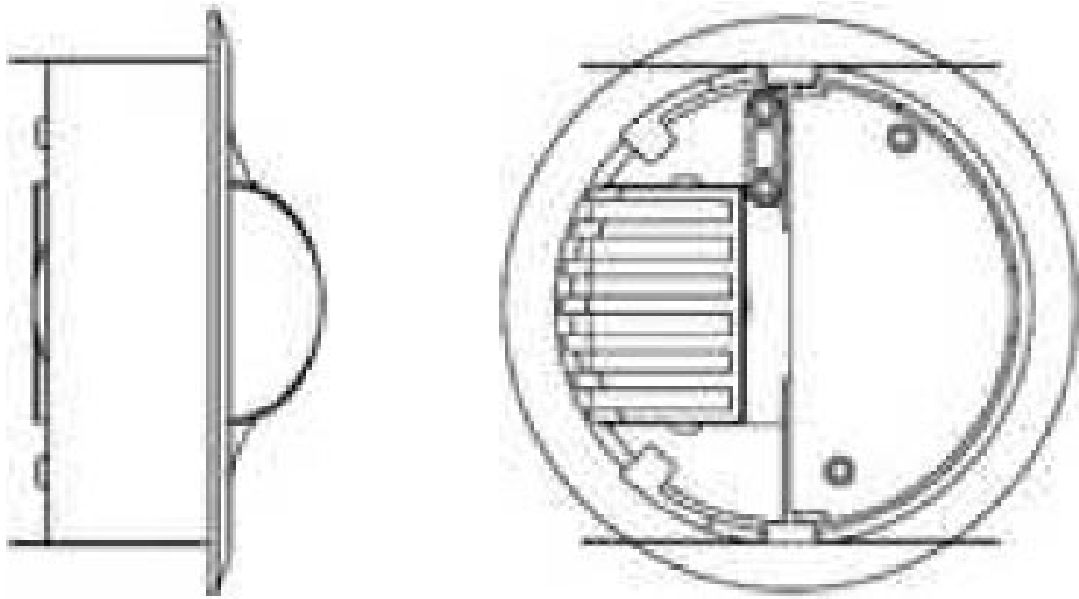

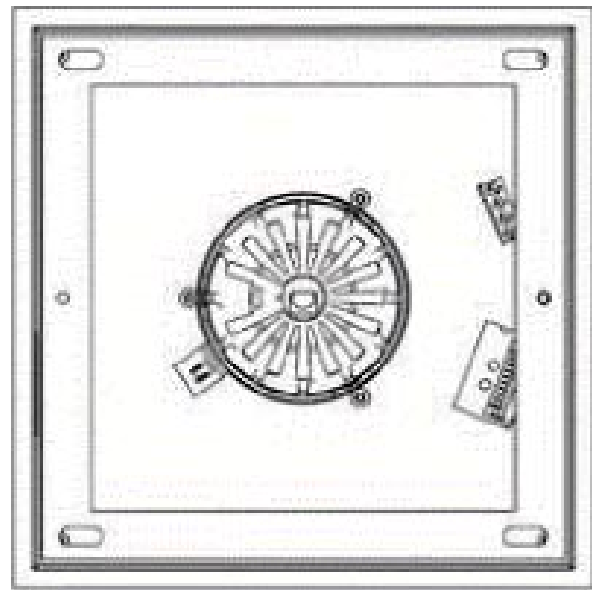
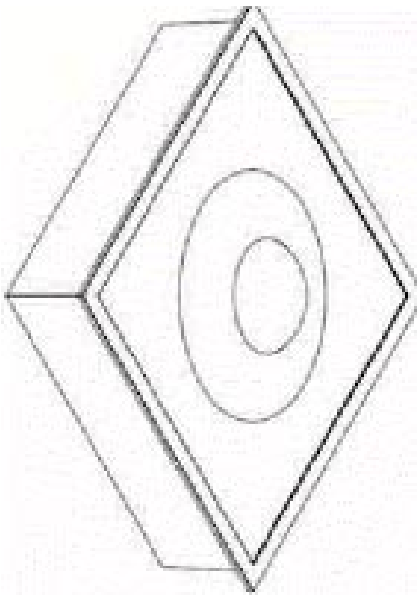
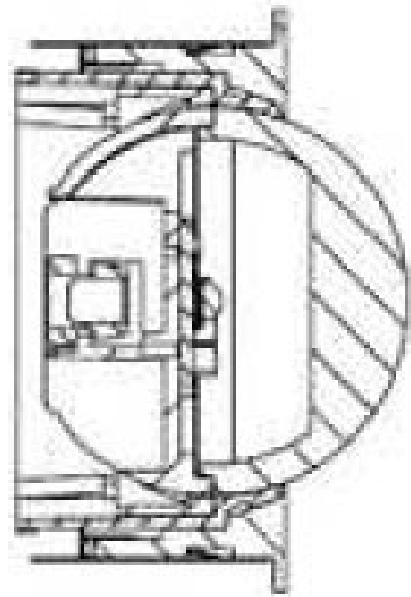
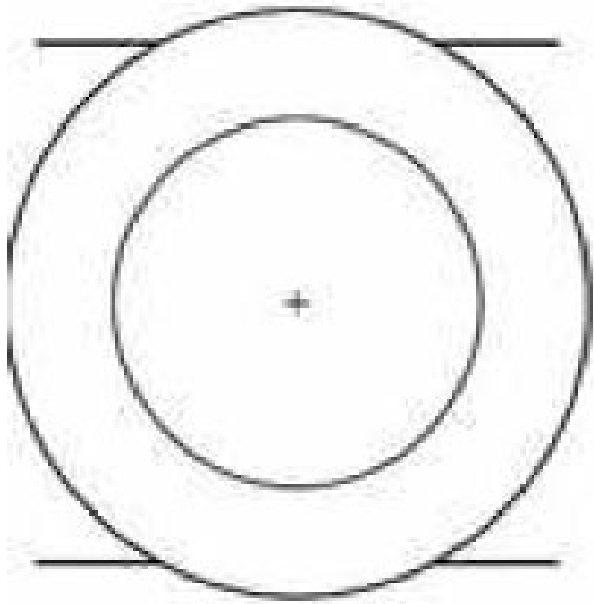

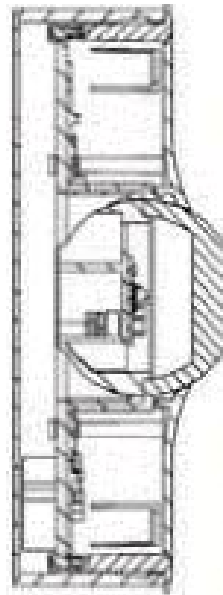
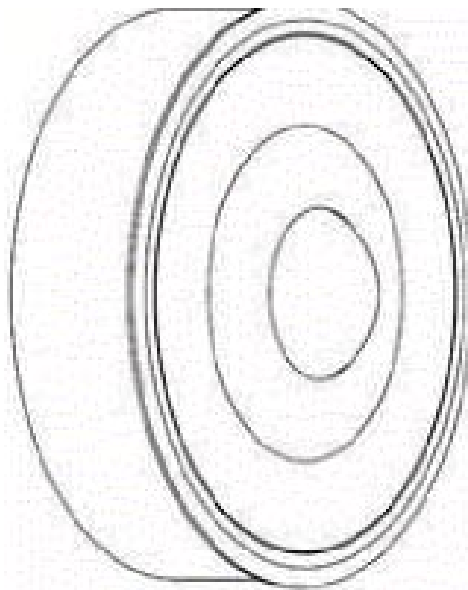
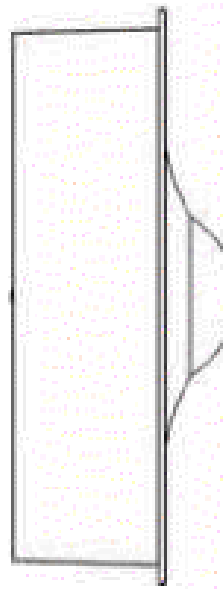
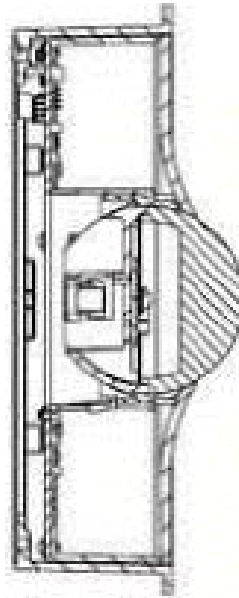

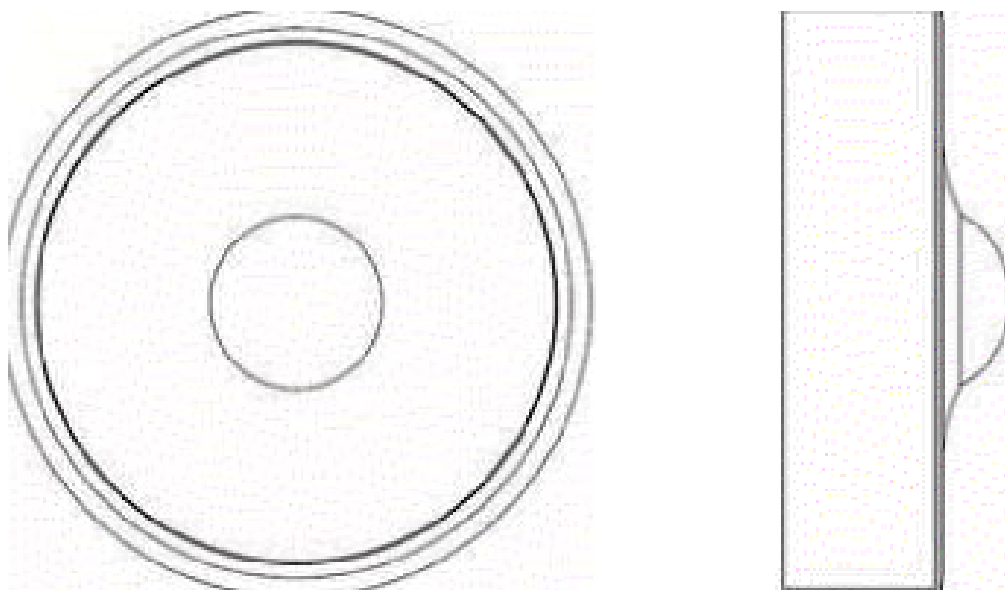

(71) Indehaver: TMO GMBH C/O S&K FINANCIAL SERVICES AG, Samstagernstrasse 55 CH-8832 Wollerau, Schweiz
(72) Designer:
(80) Designeringsdato: 2011-04-15
(80) International registreringsdato: 2011-04-15

Mønster

Ændringer

Ændringer vedrørende retten til mønstret, mønsterhavers navn, bopæl, fulm. m.v.

Overdragelser:

(11) MR 2001 00864

Til: (71) Nextlink IPR AB, Box 151, S-201 21 Malmö, Sverige

Ændring af fuldmægtigoplysninger:

(11) MR 2001 00864

Til: (74) Plougmann & Vingtoft A/S, Sundkrogsgade 9, 2100 København Ø, Danmark

WIPO Standard 80

INID-koder

Internationally agreed Numbers for the Identification of (bibliographic) data (INID)

- (11) Serial number of the registration
- (15) Date of the registration/Date of the renewal
- (17) Expected duration of the registration/
renewal
- (18) Expected expiration date of the registration/
renewal
- (21) Serial number of the application
- (22) Date of filing of the application
- (23) Name and place of exhibition, and date on
which the industrial design was first
exhibited there (Exhibition priority date)
- (24) Date from which the industrial design right
has effect
- (29) Indication of the form in which the industrial
design is filed, e.g. as a reproduction of the
industrial design or as a specimen thereof
- (30) Data relating to priority under the Paris
Convention
- (43) Date of publication of the industrial design
before examination
- (44) Date of publication of the industrial design
after examination but before registration
- (45) Date of publication of the registered
industrial design
- (46) Date of expiration of deferment
- (51) International Classification for Industrial
Designs (class and subclass of the Locarno
Classification)
- (54) Designation of article(s) or product(s)
covered by the industrial design or title of
the industrial design
- (55) Reproduction of the industrial design (e.g.,
drawing, photograph) and explanations
relating to the reproduction
- (57) Description of characteristic features of the
industrial design including indication of
colors
- (58) Date of recording of any kind of
amendment in the Register
- (62) Serial number(s) and, if available, filing
date(s) of application(s), registration(s) or
document(s) related by division
- (66) Serial number(s) of the application or the
registration of the design(s), which is(are) a
variant(s) of the present one
- (71) Name(s) and address(es) of the appli-
cant(s)
- (72) Name(s) of the creator(s) if known to be
such
- (73) Name(s) and address(es) of the owner(s)
- (74) Name(s) and address(es) of the
representative(s)

Domestic Codes for the Identification of Data

- (DL) Data concerning license
- (DP) Data concerning pawning

Internationalt vedtagne Numre til Identifikation af Data (INID)

Registreringsnummer
Registreringsdato/fornyelsesdato
Forventet registreringsperiode/fornyelsesperiode
Forventet udløbsdato for registrering/fornyelse

Ansøgningsnummer
Ansøgningsdato
Udstillingsnavn og -sted og dato for første udstil-
ling (udstillingsprioritetsoplysninger)

Indleveringsdato

Angivelse af i hvilken form designet er indleveret,
fx som en afbildning af designet eller som en
model heraf
Oplysninger om prioritet efter Pariserkonventionen

Dato for offentlig tilgængelighed

Bekendtgørelsesdato for ansøgningen

Offentliggørelse af registreringen

Udsættelsesdato
International klassifikation af design (klasser og
underklasser i Locarno Klassifikationen)

Vareangivelse/produktangivelse

Afbildninger af designet (fx tegninger, fotografier)
og forklaringer vedrørende afbildningerne

Beskrivelse af karakteristiske træk vedr. designet,
herunder angivelse af farver
Dato for tilførsel til registret

Nummer på hovedansøgning eller udskilt ansøg-
ning

Numre på beslægtede ansøgninger

Ansøgners navn og -adresse
Frembringers/designers navn og adresse
Indehavernavn og -adresse
Fuldmægtignavn og -adresse

Interne koder til identifikation af data

Licensoplysninger
Pantoplysninger
Oplysninger om konkurs