



PATENT- OG VAREMÆRKESTYRELSEN

Dansk Design- tidende

Indholdsfortegnelse

Designsager

Offentliggørelse af designregistreringer	192
Offentligt tilgængelige designansøgninger	200
Ændringer til design	201
Fornyelse af designregistreringer	202
Offentliggørelse af internationale designregistreringer	203

Mønstersager

Ændringer til mønstre	231
Fornyelse af mønsterregistreringer	232

Dansk Designtidende kan rekvireres som papirkopi for kr. 150 stk. på tlf. 43 50 85 35

Ansvarlig for redaktion: Keld Nymann Jensen
Udgives af Patent- og Varemærkestyrelsen, Helgeshøj Allé 81, 2630 Tåstrup, tlf. 43 50 80 00

ISSN 1601-7374

Design

Offentliggørelse af designregistreringer

Enhver kan anmode om hel- eller delvis udslettelse af en registrering (administrativ prøvning), jf. § 25 i designlov nr. 1259 af 20. december 2000. En model af designet kan ses i Patent- og Varemærkestyrelsen, hvis det er offentliggjort, at en model er indleveret til styrelsen. Det er anført, hvis et design er registreret i farve.

(11) DR 2011 00062
(21) DA 2011 00002

(54) En souvenirfigur

(51)-Cl.11 02

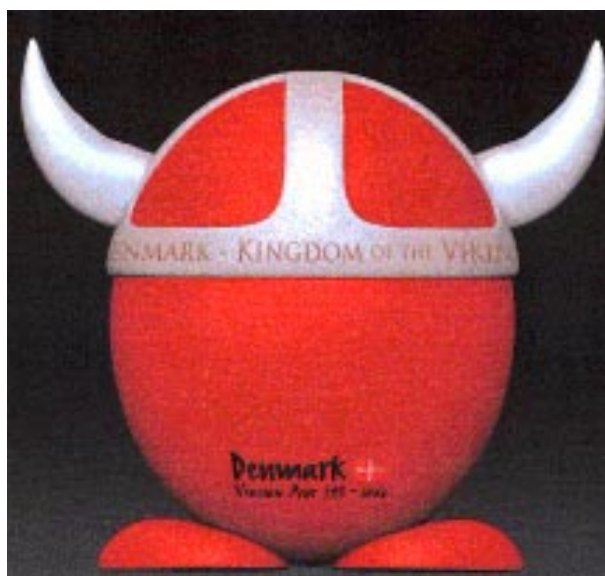

(71) ANSØGER(E):
(22) ANSØGNINGSDATO:
(18) GYLDIG TIL:
(57) BEMÆRKNINGER

APT 2000 ApS, Magleholm 13, 2600 Glostrup, Danmark
2011-01-11
2016-01-11
Farver

(11) DR 2011 00063
(21) DA 2011 00100

(54) 1-3 Køkkenmøbler

(51)-Cl.06 05



Løbenr. 1



Løbenr. 1

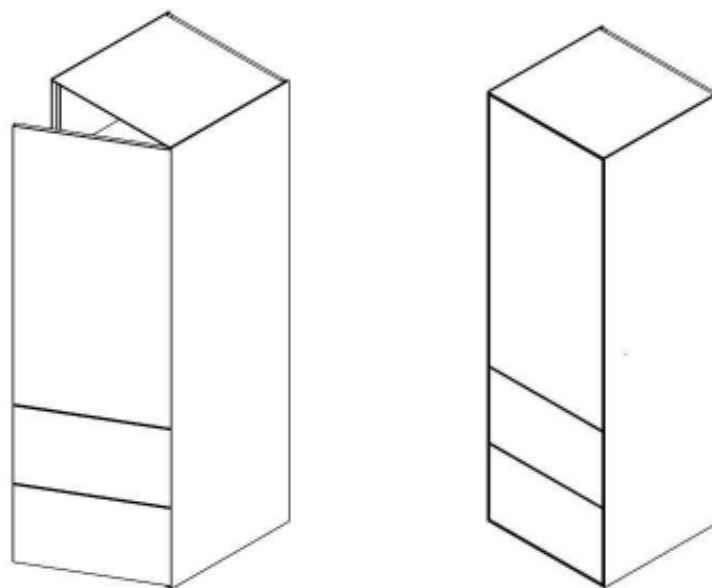

Løbenr. 2

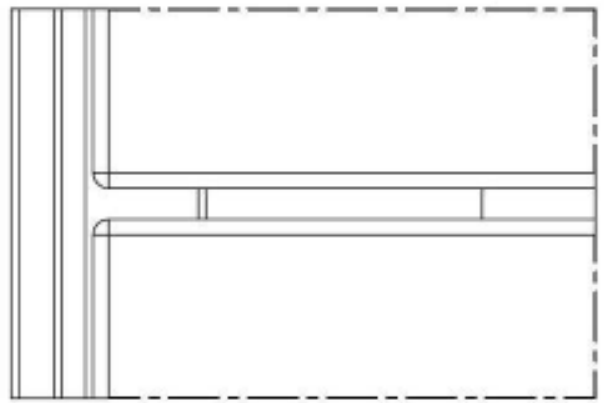
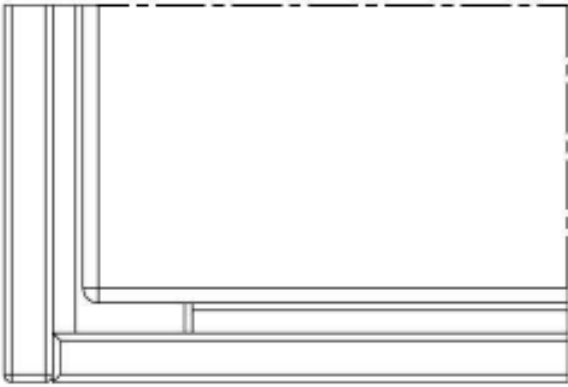

Løbenr. 2

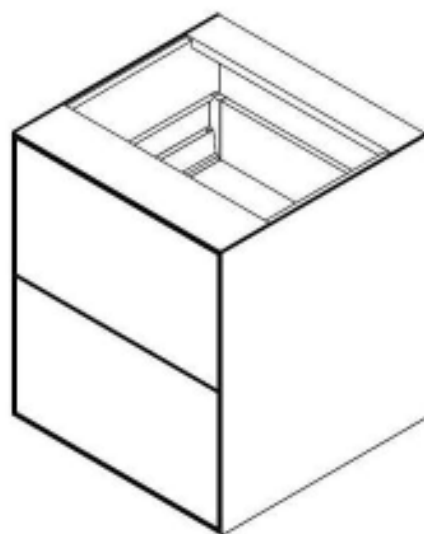
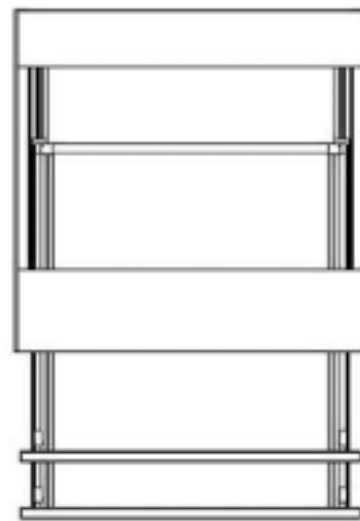
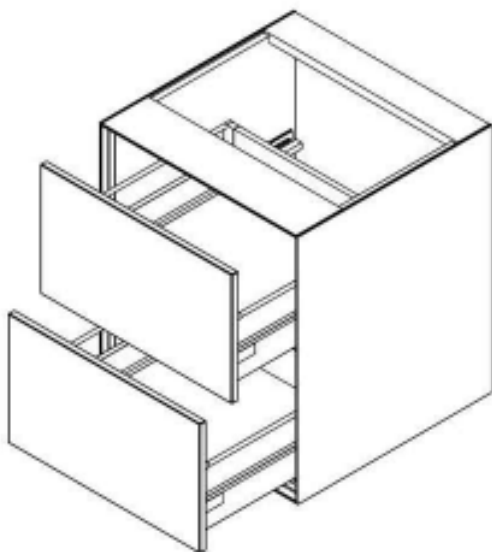

Løbenr. 3

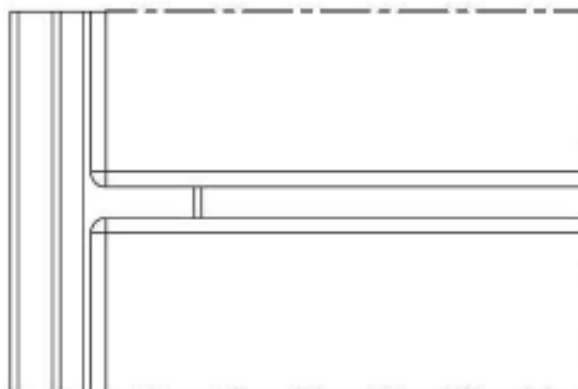
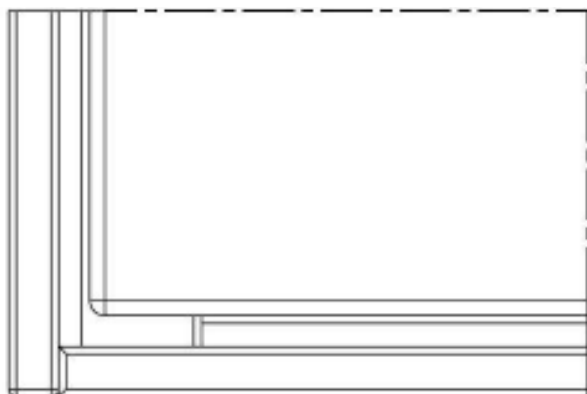

Løbenr. 3

(71) ANSØGER(E): TMK A/S, Skautrupvej 16, 7500 Holstebro, Danmark
 (74) FULDMÆGTIG: Plesner Advokatfirma, Amerika Plads 37, 2100 København Ø, Danmark
 (22) ANSØGNINGSDATO: 2011-08-12
 (18) GYLDIG TIL: 2016-08-12

(11) DR 2011 00064
 (21) DA 2011 00102

(54) En perle

(51)-Cl.11 01

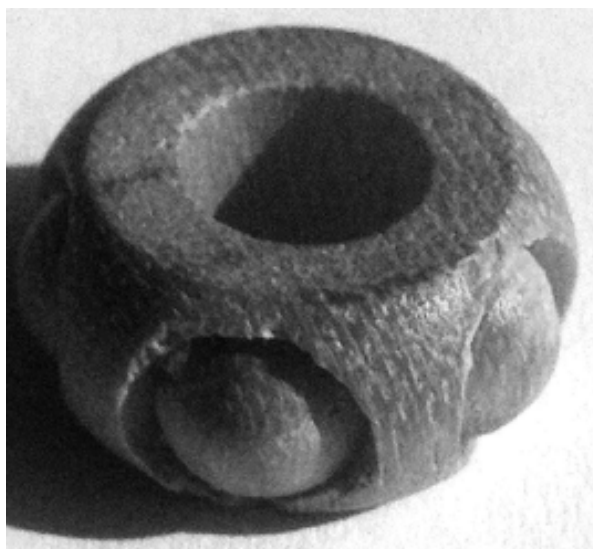

(71) ANSØGER(E): KFN Finmekanik ApS, Skovlunde Byvej 96, 2740 Skovlunde, Danmark
 (74) FULDMÆGTIG: Martinelli Advokatfirma, Alhambravej 7, 1826 Frederiksberg C, Danmark
 (22) ANSØGNINGSDATO: 2011-08-17
 (18) GYLDIG TIL: 2016-08-17

(11) DR 2011 00065
(21) DA 2011 00039

(54) Et spillebræt

(51)-Cl.21 01





(71) ANSØGER(E): Bridgebutikken, Møntergade 12, 1116 København K, Danmark
(22) ANSØGNINGSDATO: 2011-03-10
(18) GYLDIG TIL: 2016-03-10

(11) DR 2011 00066
(21) DA 2011 00076

(54) En bænk

(51)-Cl.06 01



(71) ANSØGER(E):
(22) ANSØGNINGSDATO:
(18) GYLDIG TIL:

Jens Kjartan Mogensen, Nørrebrogade 12, 2. tv, 2200 København N, Danmark
2011-05-11
2016-05-11

Offentligt tilgængelige designansøgninger og -registreringer

Akterne i nedenstående ansøgninger eller registreringer er tilgængelige for enhver, jf. § 21, stk. 2, i designlov nr. 1259 af 20. december 2000.

Klasse 12

(21) DA 2011 00036

(71) ANSØGER(E):

(22) ANSØGNINGSDATO:

(54) En foldbar scooter

Thomas Bred, Istedgade 89, 5.tv., 1650 København V, Danmark

2011-03-03

Klasse 14

(21) DA 2011 00038

(71) ANSØGER(E):

(22) ANSØGNINGSDATO:

(54) 1) et fjernsyn

Bang & Olufsen A/S, Peter Bangsvej 15, 7600 Struer, Danmark

2011-03-04

Ændringer

Ændringer vedrørende retten til designet, indehaverens navn/firma og adresse, fuldmægtig m.v.

Ændring af fuldmægtigoplysninger:

(11) DR 2001 00045

Til: (74) PATRADE A/S, Fredens Torv 3 A, 8000 Århus C, Danmark

(11) DR 2001 00046

Til: (74) PATRADE A/S, Fredens Torv 3 A, 8000 Århus C, Danmark

Fornyelse af designregistreringer

Fornyelse af registreringer foretaget i medfør af § 23, stk. 1, i designlov nr. 1259 af 20. december 2000.

(11) Registreringsnummer	(18) Gyldig til
DR 2001 00045	20111121
DR 2001 00046	20161121
DR 2002 00320	20161119
DR 2006 00227	20161013
DR 2007 00064	20160907
DR 2007 00074	20160927
DR 2007 00055	20160824
DR 2007 00053	20160824
DR 2007 00054	20160824
DR 2006 00234	20160823
DR 2001 00020	20161001

Offentliggørelse af internationale designregistreringer

Enhver kan anmode om hel eller delvis udslættelse (administrativ prøvning) af en international registrering, jf. designlovens § 54, jf. § 25. En model af designet kan ses i Patent- og Varemærkestyrelsen, hvis det er offentliggjort, at en model er indleveret i styrelsen. Det er anført, hvis et design er registreret i farve.

(11) Reg. nr.:

GD74951

(54) Vareangivelse:

1) Hood for Motor Vehicles; 2) Trunk Lid for Motor Vehicles; 3) Front Bumper for Motor Vehicles; 4) Rear Bumper for Motor Vehicles; 5) Front Door for Motor Vehicles; 6) Rear Door for Motor Vehicles; 7) Front Fender for Motor Vehicles; 8) Rear Fender for Motor Vehicles; 9) Grille for Motor Vehicles; 10) Door for Motor Vehicles; 11) Rear Fender for Motor Vehicles

(51) Cl.:

12 16

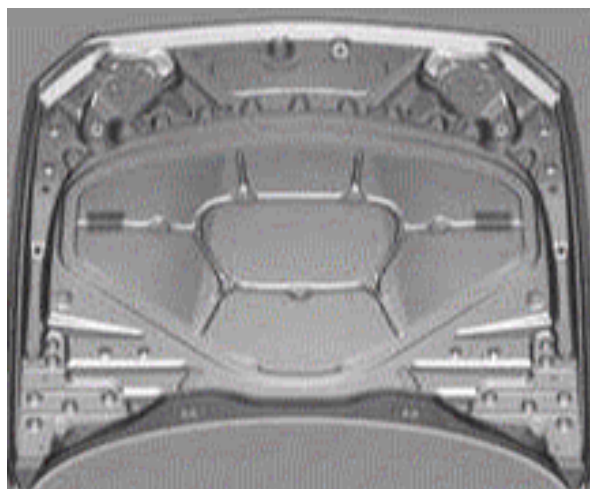
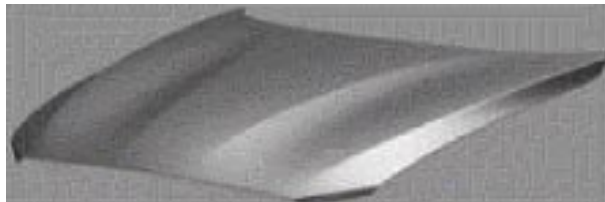



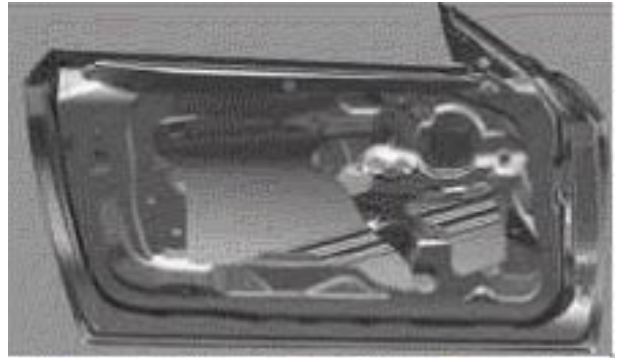
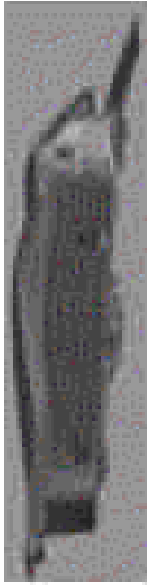

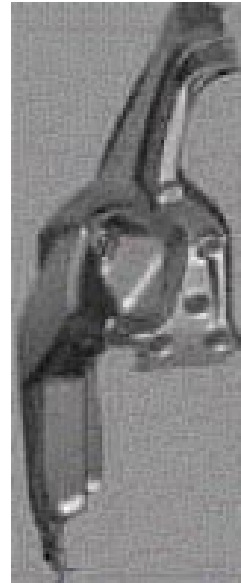
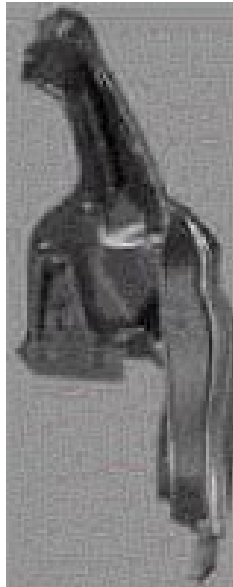
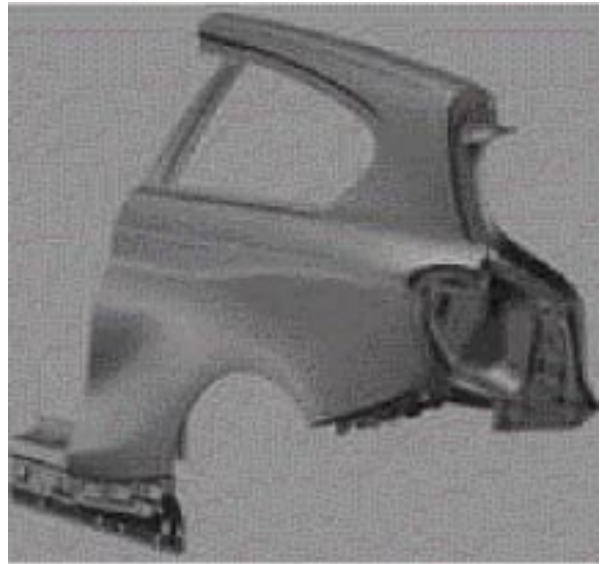

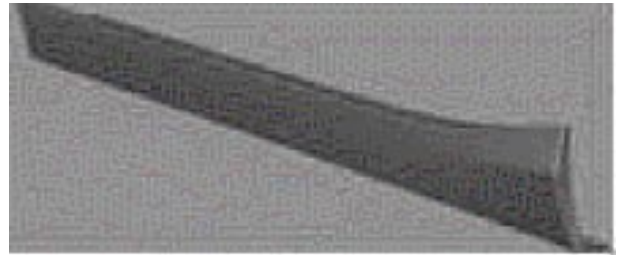
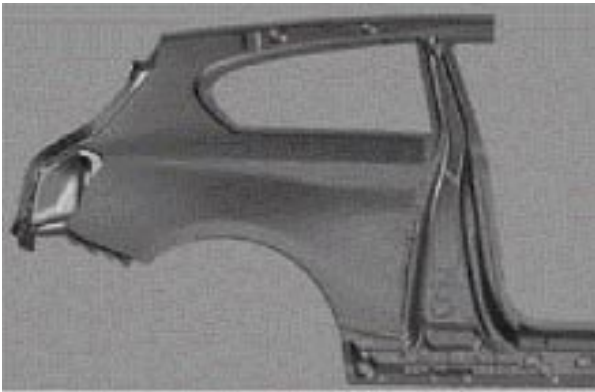

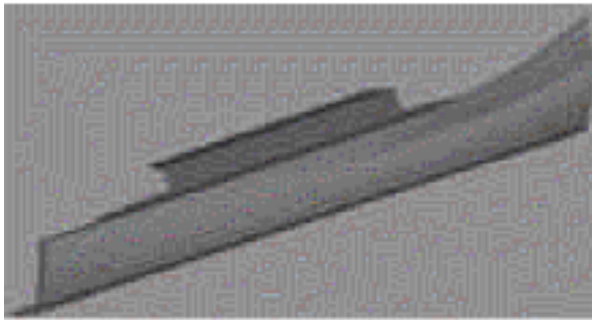

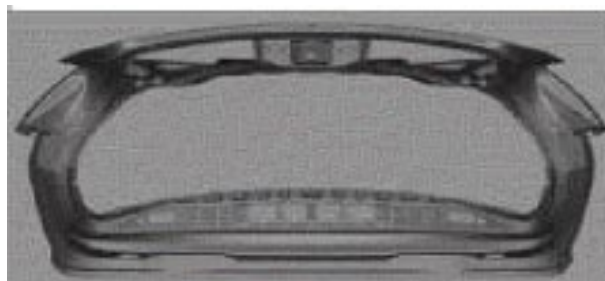
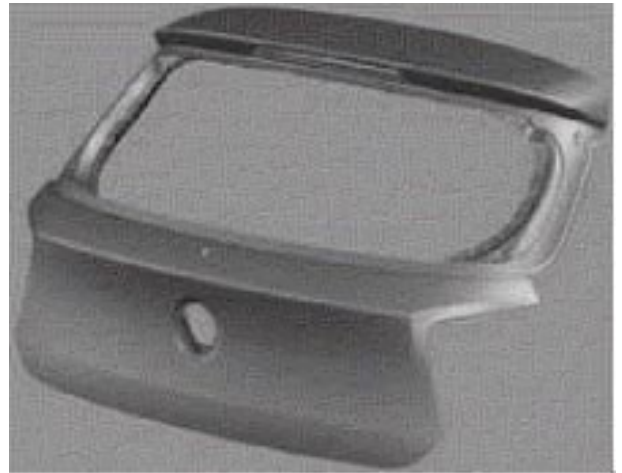
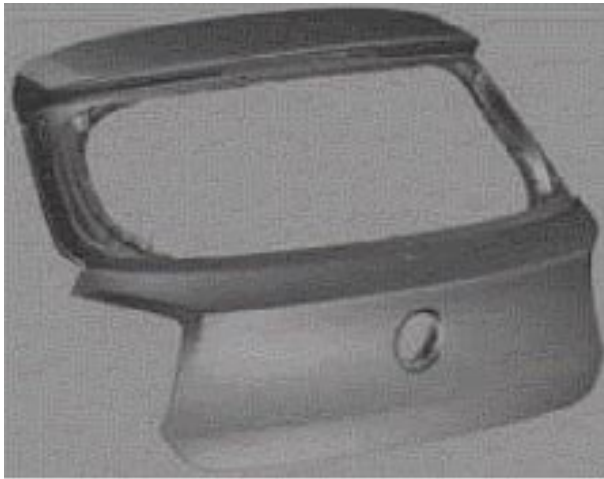

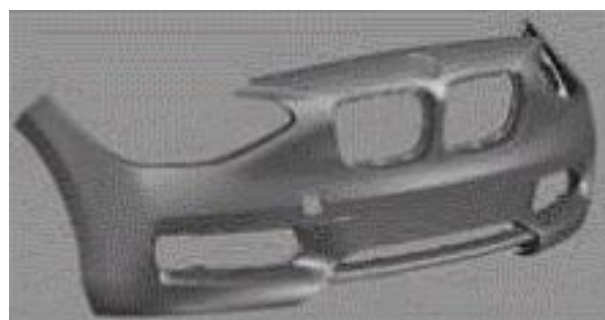
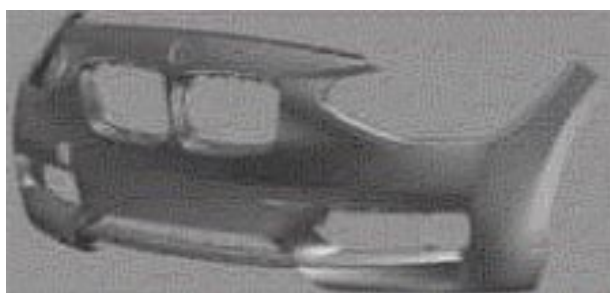
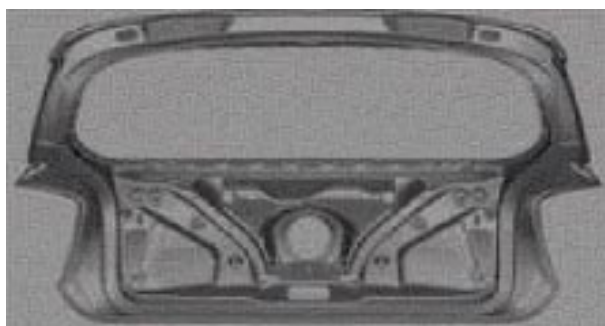

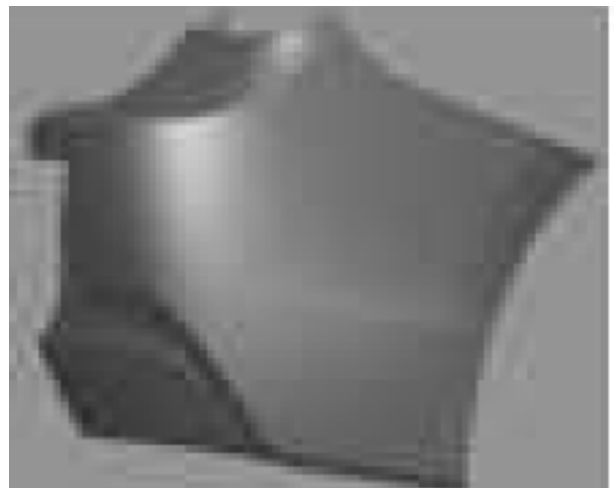
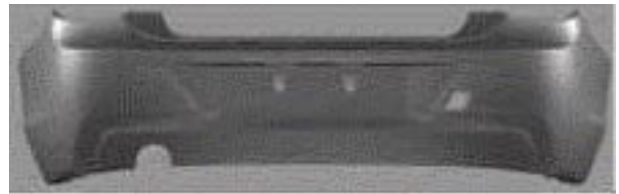
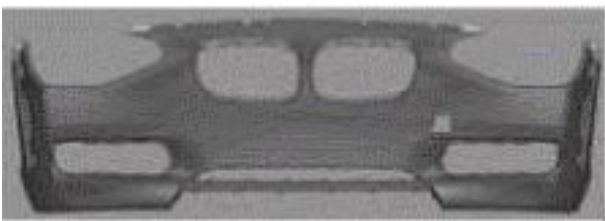
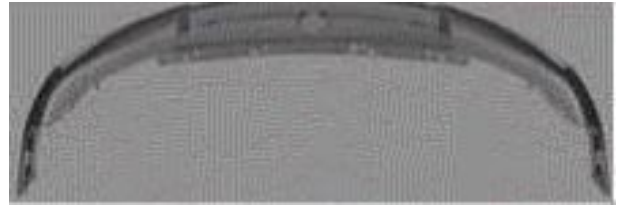



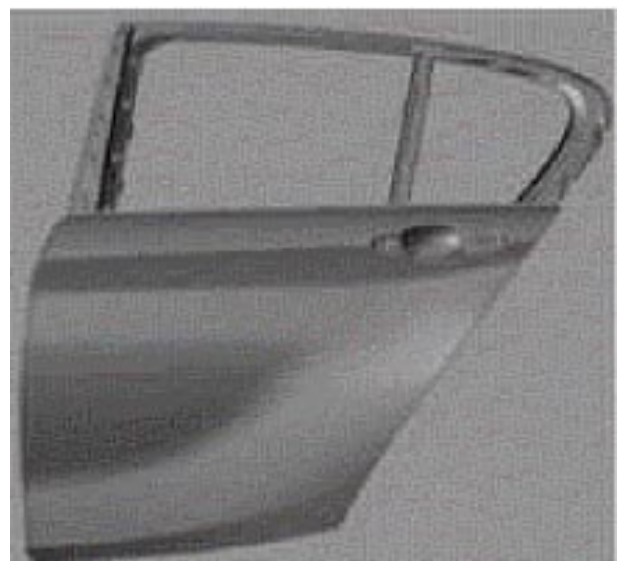
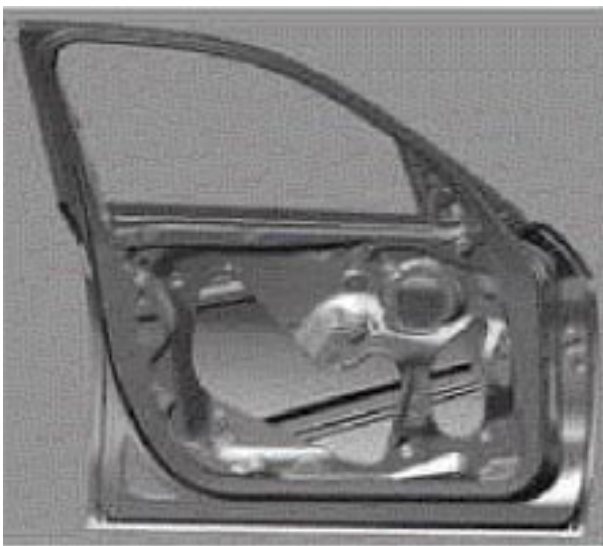
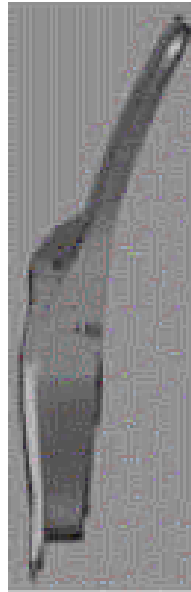

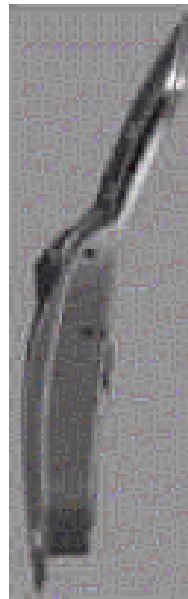
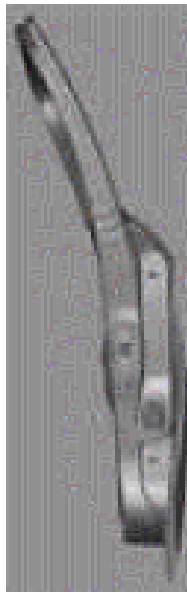
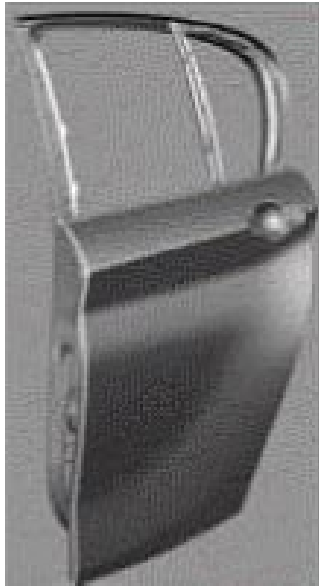

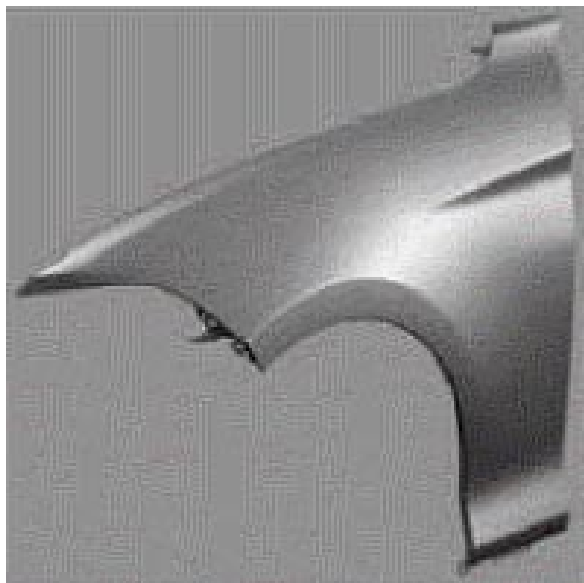
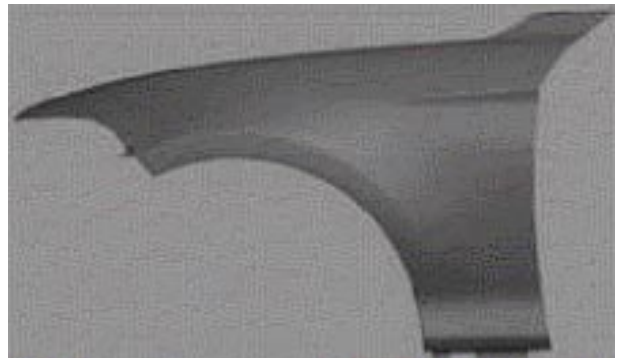

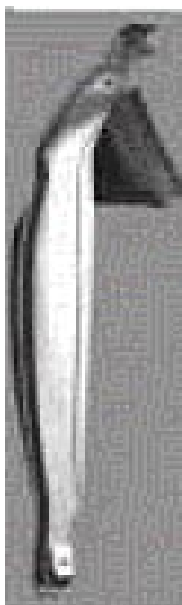

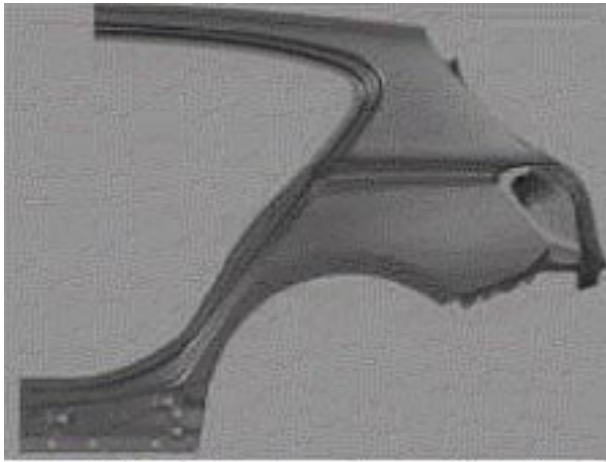

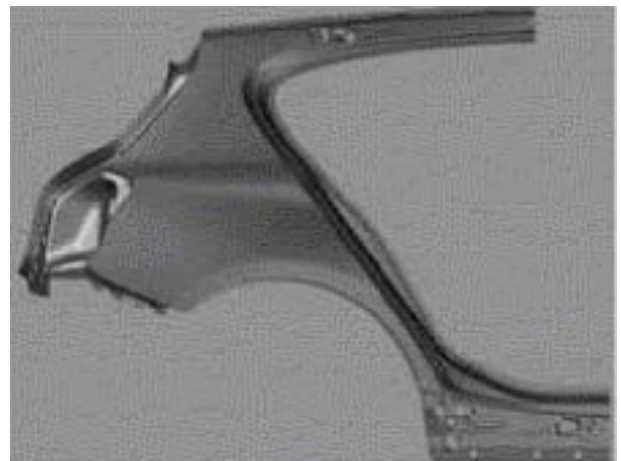
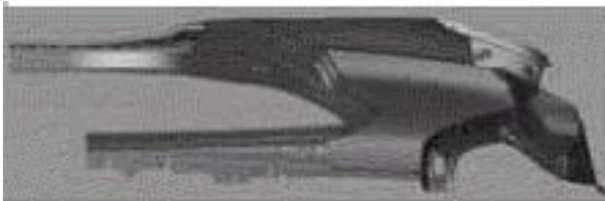

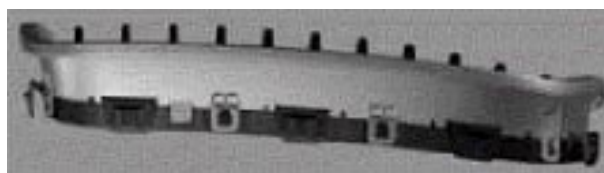
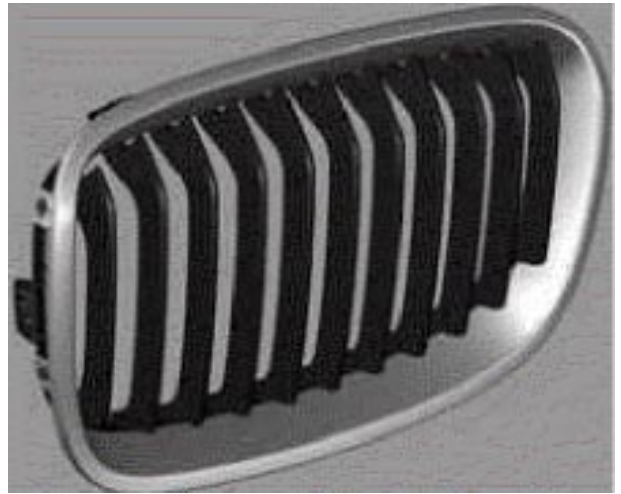

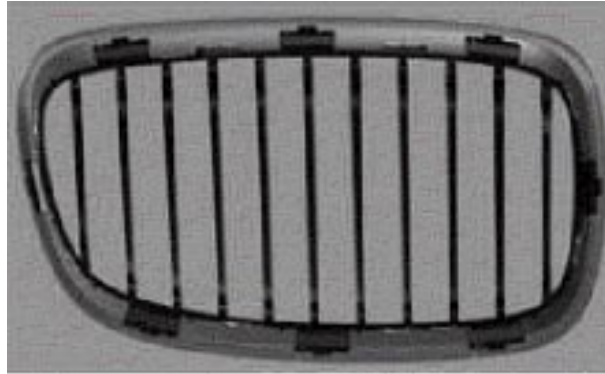

(71) Indehaver: BAYERISCHE MOTOREN WERKE AKTIENGESELLSCHAFT, Petuelring 130, 80809 München, Tyskland
(72) Designer:
(80) Designeringsdato: 2010-11-29
(80) International registreringsdato: 2010-11-29

(11) Reg. nr.: **GD75074**
(54) Vareangivelse: Cooking ustensil
(51) Cl.: 07 02



(71) Indehaver: N.D. HOOIJMANS, Belgische Wijk 4, NL-8411 WN Jubbega, Holland
(72) Designer: N.D. HOOIJMANS, Belgische Wijk 4, NL-8411 WN Jubbega, Holland
(80) Designeringsdato: 2010-10-12
(80) International registreringsdato: 2010-10-12

(11) Reg. nr.:
(54) Vareangivelse:
(51) Cl.:

GD75477
Foldable work bench
06 03

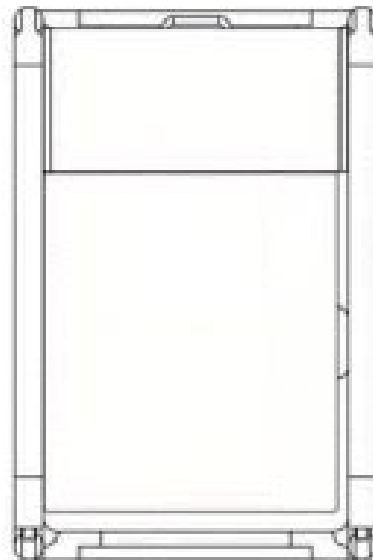
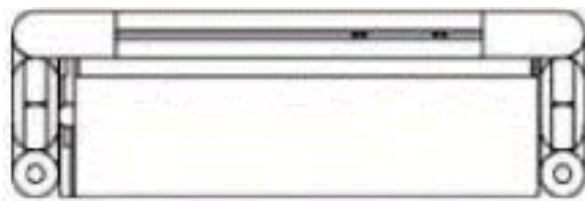

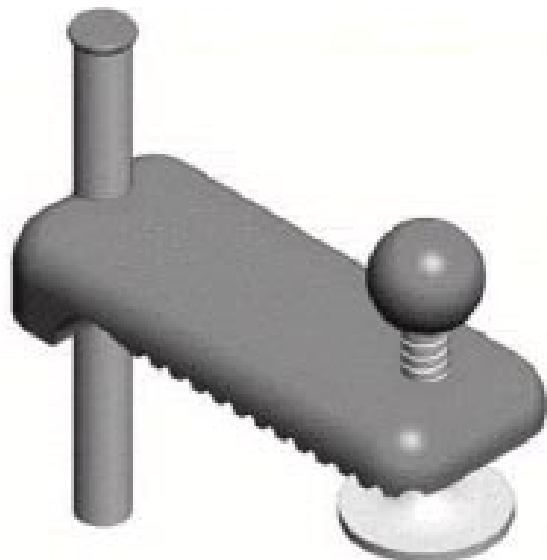

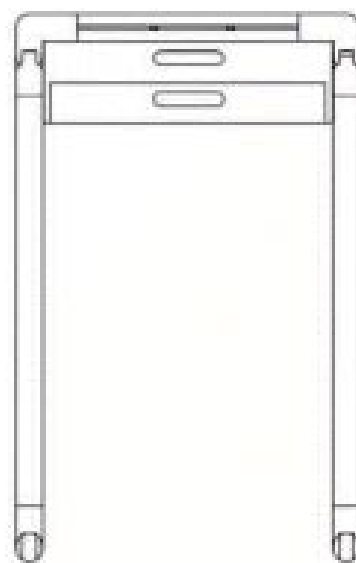
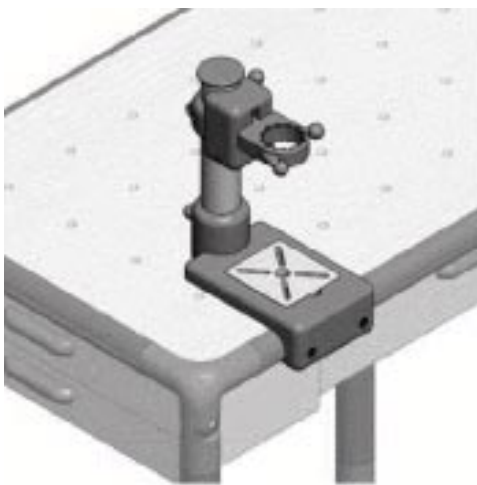
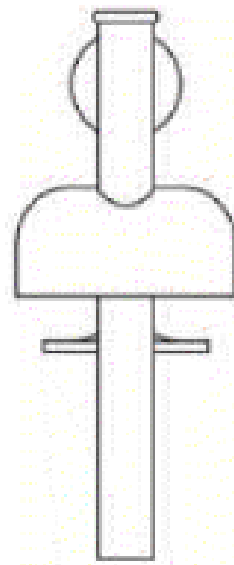
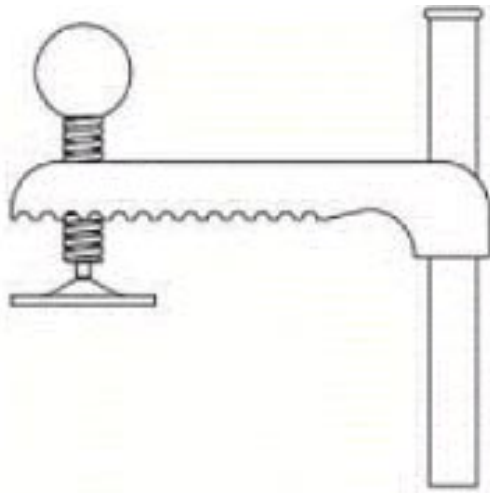

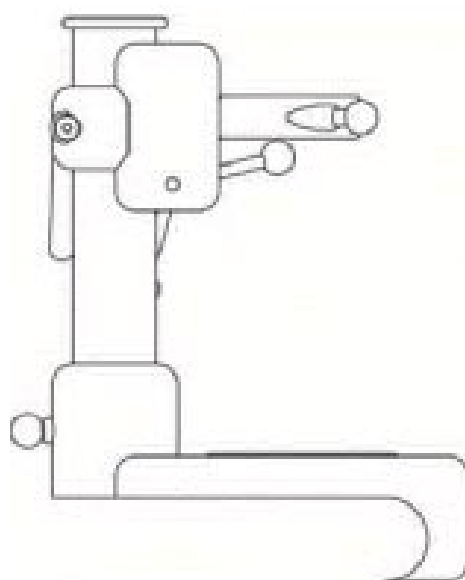
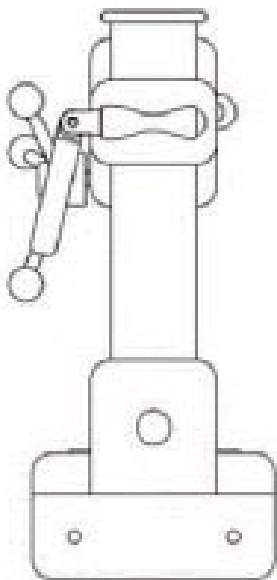
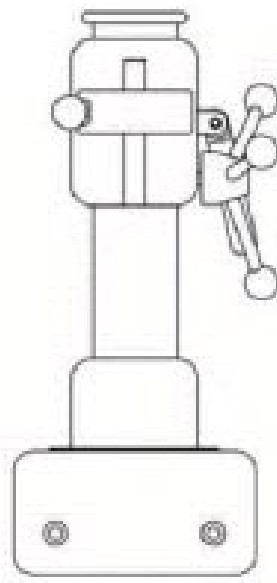

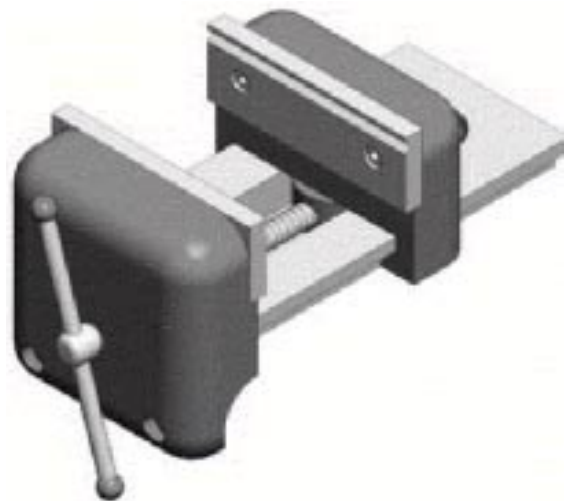
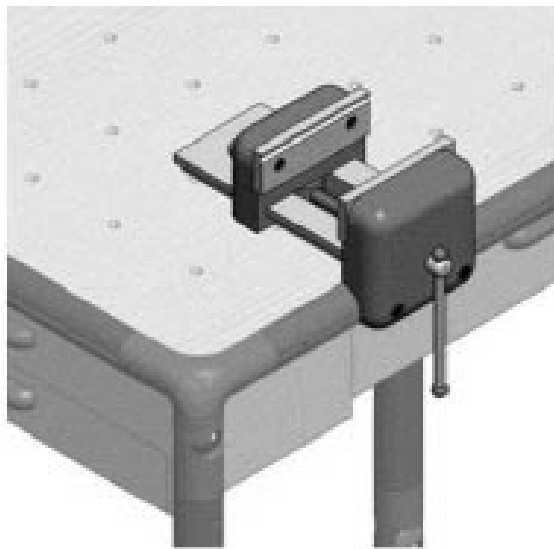
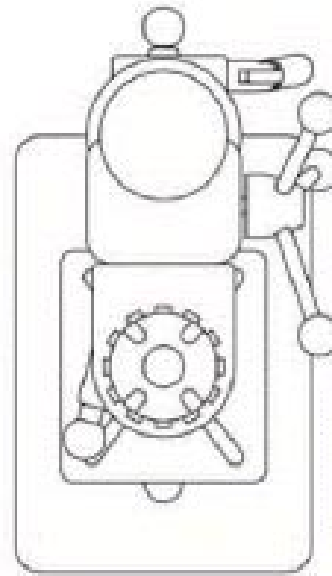
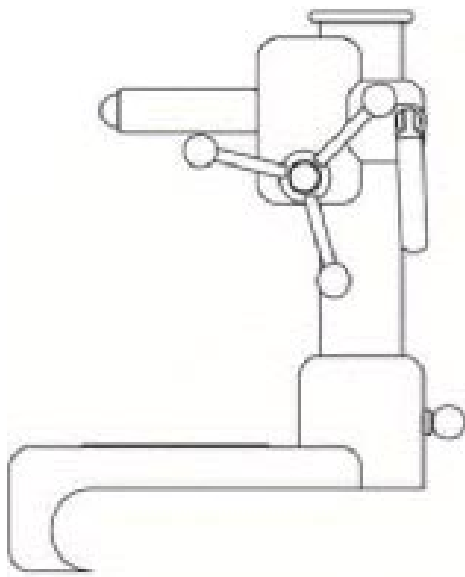

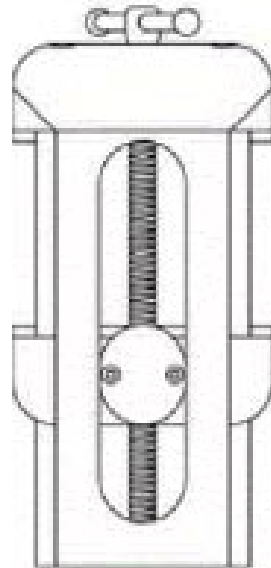
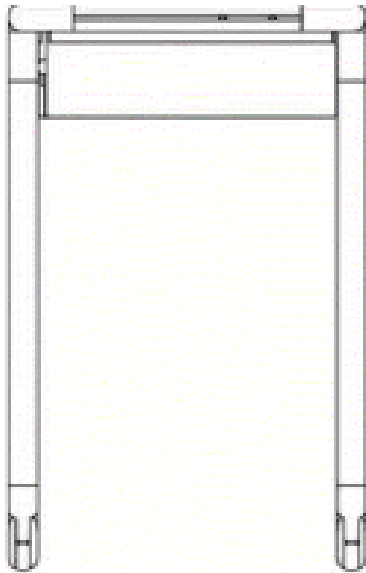
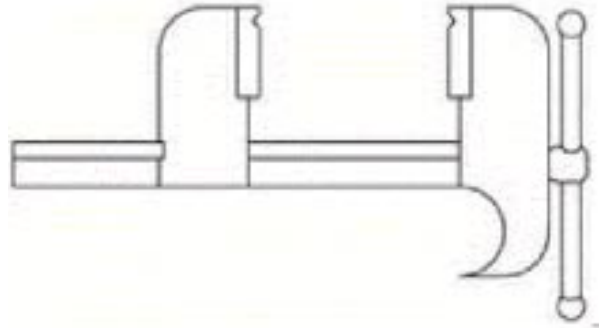
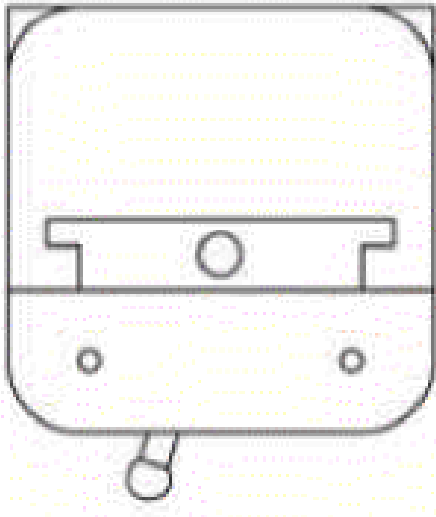

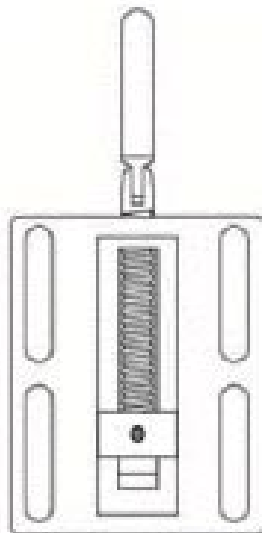
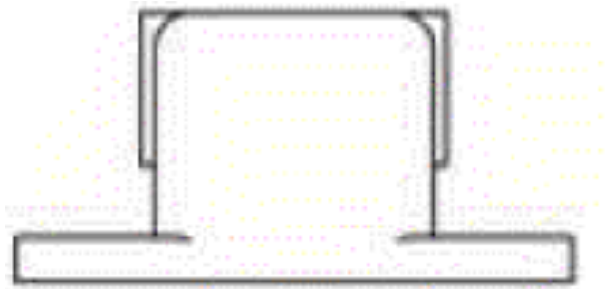
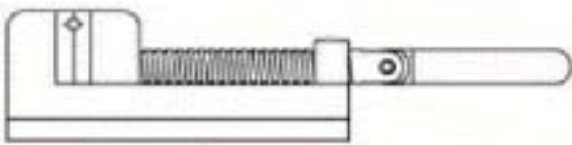
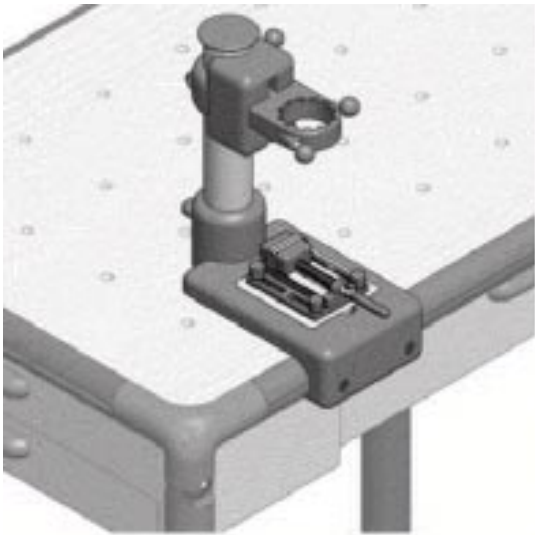

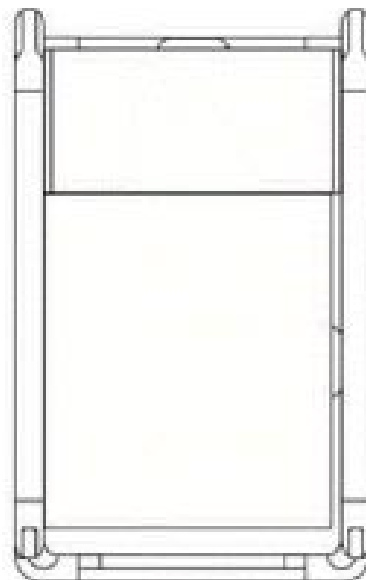
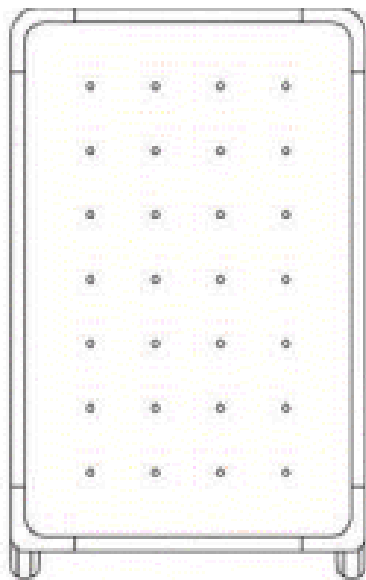

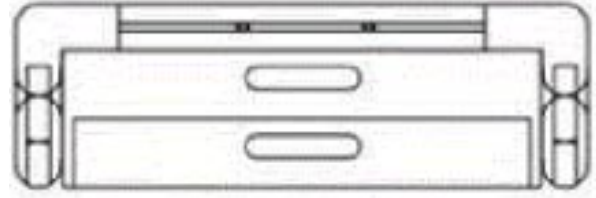

(71) Indehaver: RULENCE DAMIEN, 12 clos des Maraîchers, F-91310 Longpont sur Orge, Frankrig
(72) Designer: RULENCE DAMIEN, 12 clos des Maraîchers, F-91310 Longpont sur Orge, Frankrig
(80) Designingsdato: 2010-10-21
(80) International registreringsdato: 2010-10-21

Mønster

Ændringer

Ændringer vedrørende retten til mønstret, mønsterhavers navn, bopæl, fulm. m.v.

Overdragelser:

(11) MR 1999 00717

Til: (71) Société des Produits Nestlé S.A., CH-1800 Vevey, Schweiz

Fornyelse af mønsterregistreringer

Fornyelse af registreringer foretaget i medfør af lov om mønstre nr. 218 af 27. maj 1970.

(11) Registreringsnummer	(18) Gyldig til
MR 2002 00062	20160927
MR 2002 00259	20160905
MR 2002 00263	20160905
MR 2002 00264	20160905
MR 2002 00017	20160907
MR 2002 00296	20160907
MR 2001 01178	20160830
MR 2002 00146	20160906
MR 2002 00137	20160912
MR 2002 00096	20160910
MR 2002 00009	20160921

WIPO Standard 80

INID-koder

Internationally agreed Numbers for the Identification of (bibliographic) data (INID)

- (11) Serial number of the registration
- (15) Date of the registration/Date of the renewal
- (17) Expected duration of the registration/
renewal
- (18) Expected expiration date of the registration/
renewal
- (21) Serial number of the application
- (22) Date of filing of the application
- (23) Name and place of exhibition, and date on
which the industrial design was first
exhibited there (Exhibition priority date)
- (24) Date from which the industrial design right
has effect
- (29) Indication of the form in which the industrial
design is filed, e.g. as a reproduction of the
industrial design or as a specimen thereof
- (30) Data relating to priority under the Paris
Convention
- (43) Date of publication of the industrial design
before examination
- (44) Date of publication of the industrial design
after examination but before registration
- (45) Date of publication of the registered
industrial design
- (46) Date of expiration of deferment
- (51) International Classification for Industrial
Designs (class and subclass of the Locarno
Classification)
- (54) Designation of article(s) or product(s)
covered by the industrial design or title of
the industrial design
- (55) Reproduction of the industrial design (e.g.,
drawing, photograph) and explanations
relating to the reproduction
- (57) Description of characteristic features of the
industrial design including indication of
colors
- (58) Date of recording of any kind of
amendment in the Register
- (62) Serial number(s) and, if available, filing
date(s) of application(s), registration(s) or
document(s) related by division
- (66) Serial number(s) of the application or the
registration of the design(s), which is(are) a
variant(s) of the present one
- (71) Name(s) and address(es) of the appli-
cant(s)
- (72) Name(s) of the creator(s) if known to be
such
- (73) Name(s) and address(es) of the owner(s)
- (74) Name(s) and address(es) of the
representative(s)

Domestic Codes for the Identification of Data

- (DL) Data concerning license
- (DP) Data concerning pawning

Internationalt vedtagne Numre til Identifikation af Data (INID)

Registreringsnummer
 Registreringsdato/fornyelsesdato
 Forventet registreringsperiode/fornyelsesperiode
 Forventet udløbsdato for registrering/fornyelse

Ansøgningsnummer
 Ansøgningsdato
 Udstillingsnavn og -sted og dato for første udstil-
 ling (udstillingsprioritetsoplysninger)

Indleveringsdato

Angivelse af i hvilken form designet er indleveret,
 fx som en afbildning af designet eller som en
 model heraf
 Oplysninger om prioritet efter Pariserkonventionen

Dato for offentlig tilgængelighed

Bekendtgørelsesdato for ansøgningen

Offentliggørelse af registreringen

Udsættelsesdato
 International klassifikation af design (klasser og
 underklasser i Locarno Klassifikationen)

Vareangivelse/produktangivelse

Afbildninger af designet (fx tegninger, fotografier)
 og forklaringer vedrørende afbildningerne

Beskrivelse af karakteristiske træk vedr. designet,
 herunder angivelse af farver
 Dato for tilførsel til registret

Nummer på hovedansøgning eller udskilt ansøg-
 ning

Numre på beslægtede ansøgninger

Ansøgners navn og -adresse
 Frembringers/designers navn og adresse
 Indehavernavn og -adresse
 Fuldmægtignavn og -adresse

Interne koder til identifikation af data

Licensoplysninger
 Pantoplysninger
 Oplysninger om konkurs