



PATENT- OG VAREMÆRKESTYRELSEN

# Dansk Design- tidende

## Indholdsfortegnelse

### Designsager

Offentliggørelse af designregistreringer .....	84
Offentligt tilgængelige designansøgninger .....	102
Fornyelse af designregistreringer .....	103
Udslettelse af designregistreringer .....	104

### Mønstersager

Henlagte, afslåede eller tilbagetagne mønsteransøgninger .....	106
Ændringer til mønstre .....	107
Fornyelse af mønsterregistreringer .....	108
Udslettelse af mønsterregistreringer .....	109

Dansk Designtidende kan rekvireres som papirkopi for kr. 150 stk. på tlf. 43 50 85 35

Ansvarlig for redaktion: Keld Nymann Jensen  
Udgives af Patent- og Varemærkestyrelsen, Helgeshøj Allé 81, 2630 Tåstrup, tlf. 43 50 80 00

ISSN 1601-7374

Design

## Offentliggørelse af designregistreringer

Enhver kan anmode om hel- eller delvis udslettelse af en registrering (administrativ prøvning), jf. § 25 i designlov nr. 1259 af 20. december 2000. En model af designet kan ses i Patent- og Varemærkestyrelsen, hvis det er offentliggjort, at en model er indleveret til styrelsen. Det er anført, hvis et design er registreret i farve.

(11) DR 2008 00029  
(21) DA 2008 00031

(54) Et spil

(51)-Cl.21 01

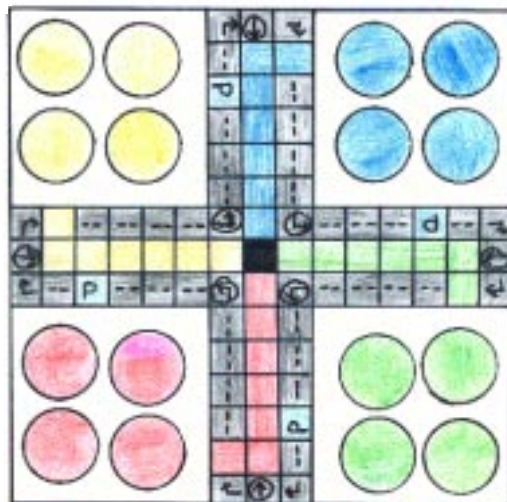

(71) ANSØGER(E):  
(72) FREMBRINGER(E):  
(22) ANSØGNINGSDATO:  
(18) GYLDIG TIL:  
(57) BEMÆRKNINGER

Klostermarkens Tømrer v/Bo Bevensee Kristiansen, Fanningers Alle 9, 6760 Ribe, Danmark  
Klostermarkens Tømrer v/Bo Bevensee Kristiansen, Fanningers Alle 9, 6760 Ribe, Danmark  
2008-02-01  
2013-02-01  
Farver

(11) DR 2008 00030  
(21) DA 2008 00011

(54) 1-2) Vaser

(51)-Cl.11 02

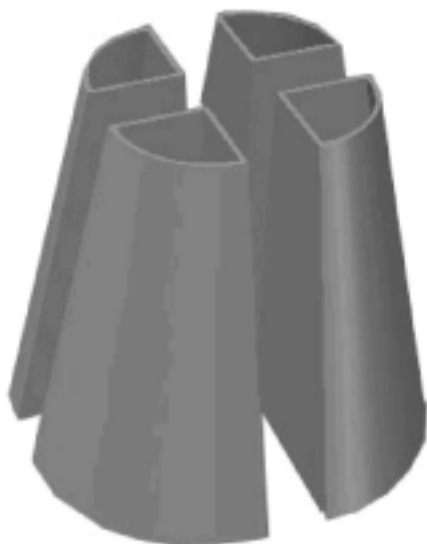

Løbenr. 1



Løbenr. 2

(71) ANSØGER(E):  
(72) FREMBRINGER(E):  
(22) ANSØGNINGSDATO:  
(18) GYLDIG TIL:

Remixography v/Remi Wei, Brofogedvej 16 3 tv, 2400 København NV, Danmark  
Remixography v/Remi Wei, Brofogedvej 16 3 tv, 2400 København NV, Danmark  
2008-01-15  
2013-01-15

(11) DR 2008 00031  
(21) DA 2007 00280

(54) En filosofi-klods

(51)-Cl.19 07



(71) ANSØGER(E):  
(22) ANSØGNINGSDATO:  
(18) GYLDIG TIL:

LUMA V/KLAUS LUNDEGAARD, Solbakken 25, 9210 Aalborg SØ, Danmark  
2007-11-22  
2012-11-22

(11) DR 2008 00032  
(21) DA 2007 00193

(54) En stempelkande

(51)-Cl.07 01;07 04

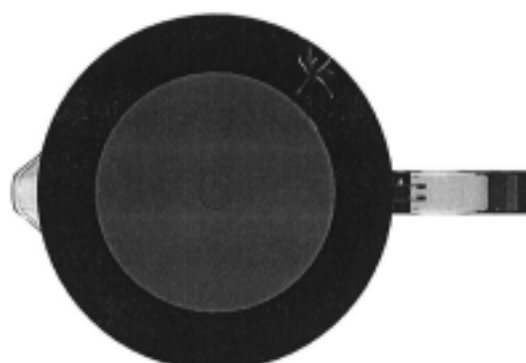
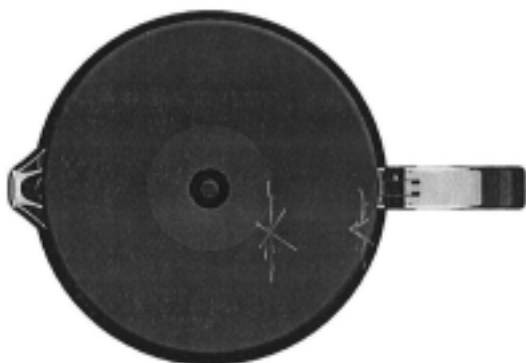

(71) ANSØGER(E):  
(74) FULDMÆGTIG:  
(22) ANSØGNINGSDATO:  
(18) GYLDIG TIL:

Pi-Design AG, Kantonsstrasse 100, CH-6234 Triengen, Schweiz  
Gorrissen Federspiel Kierkegaard, H.C. Andersens Boulevard 12, 1553 København V, Danmark  
2007-08-14  
2012-08-14

(11) DR 2008 00033  
(21) DA 2007 00290

(54) 1-12) Vielsesringe med brillanter som stjernebilleder (51)-Cl.11 01



Løbenr. 1



Løbenr. 2



Løbenr. 3



Løbenr. 4



Løbenr. 5



Løbenr. 6



Løbenr. 7



Løbenr. 8



Løbenr. 9



Løbenr. 10



Løbenr. 11



Løbenr. 12

(71) ANSØGER(E):  
(22) ANSØGNINGSDATO:  
(18) GYLDIG TIL:

SCROUPLES A/S, Sønderhøj 48, 8260 Viby J, Danmark  
2007-12-04  
2012-12-04

(11) DR 2008 00034  
(21) DA 2007 00298

(54) 1-3) Et håndset

(51)-Cl.14 03

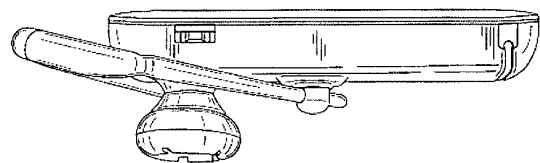
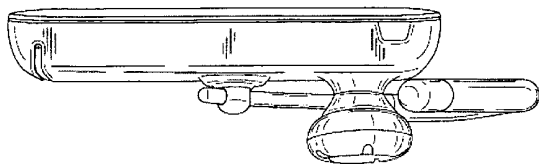
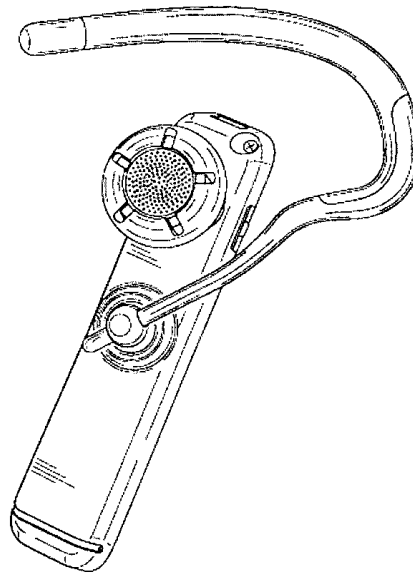
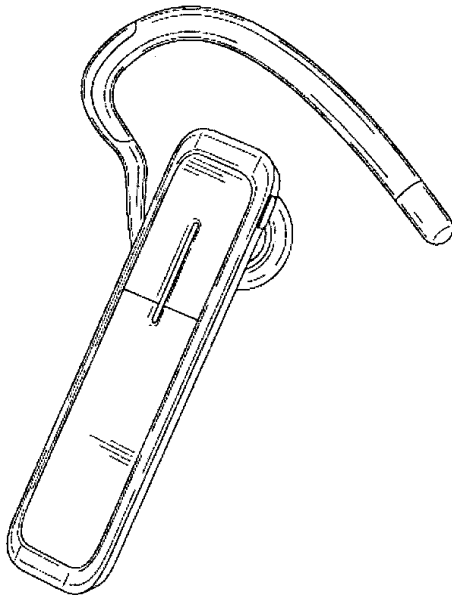
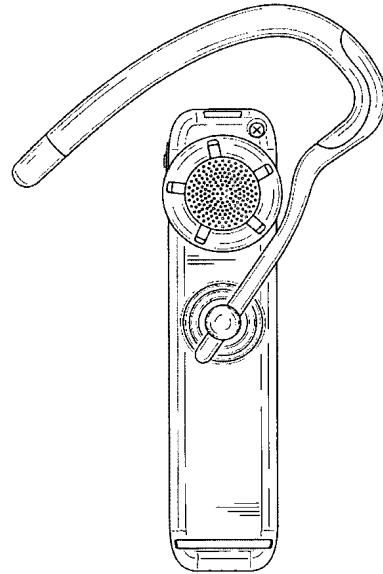
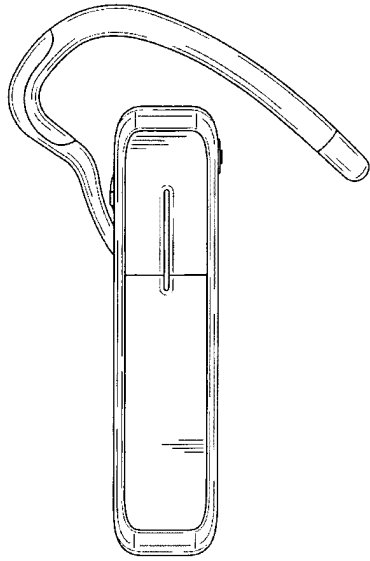

Løbenr. 1

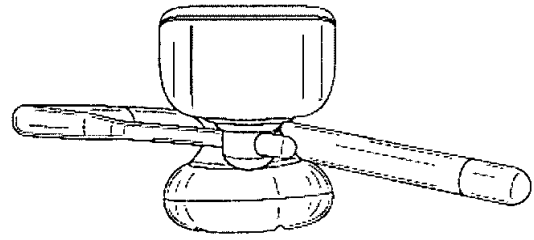
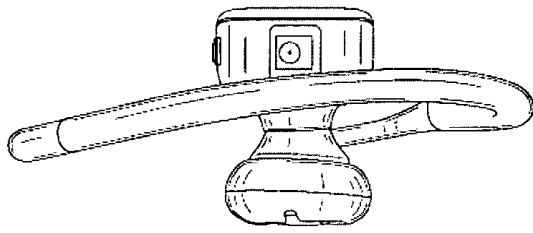

Løbenr. 1

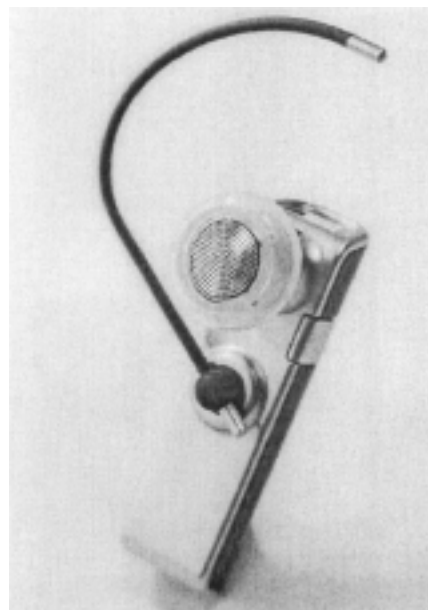
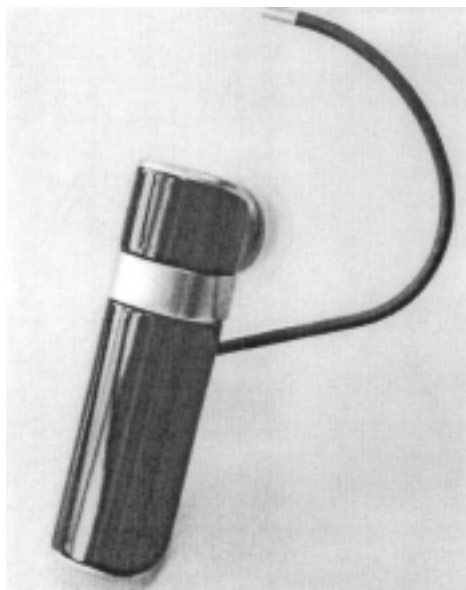
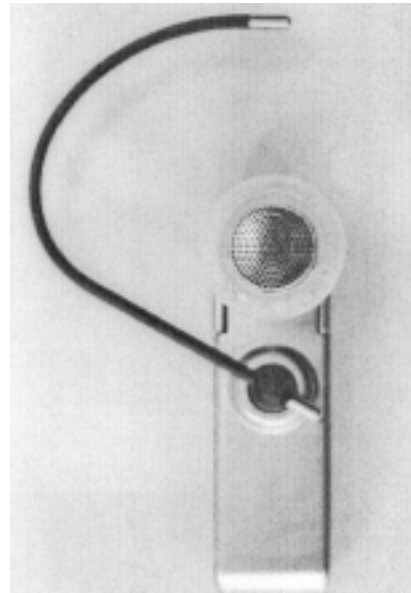

Løbenr. 2

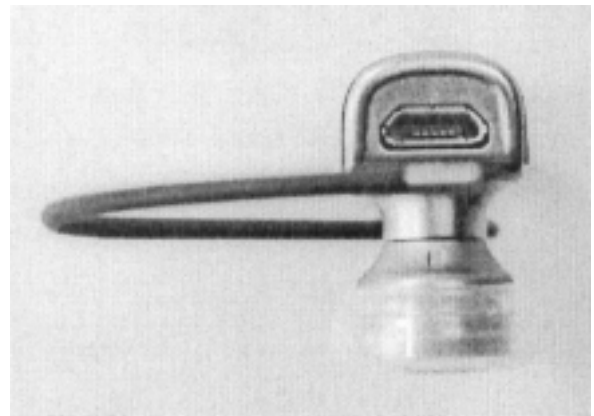
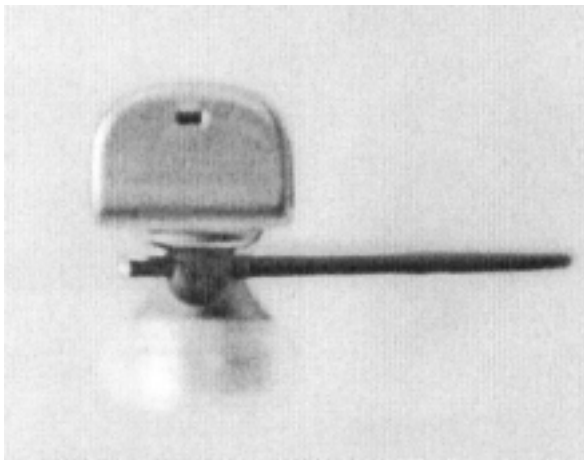
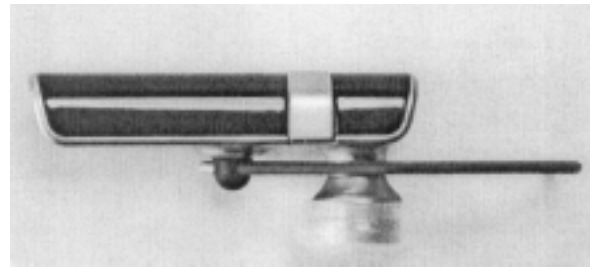
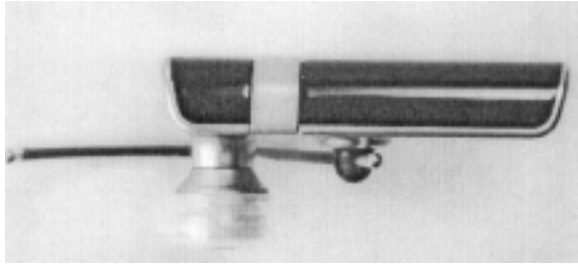

Løbenr. 2

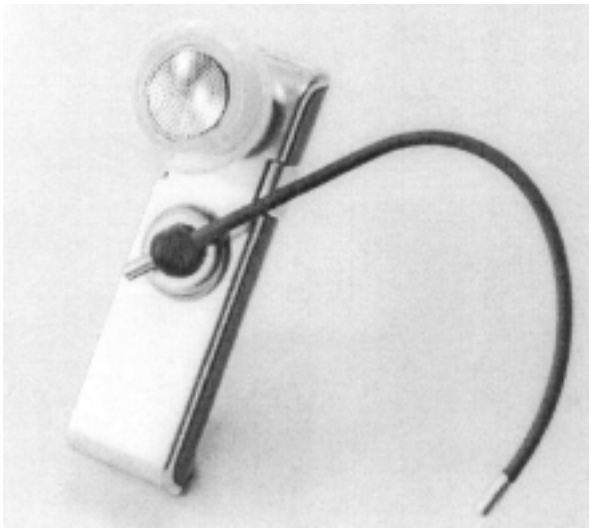

Løbenr. 2



Løbenr. 3

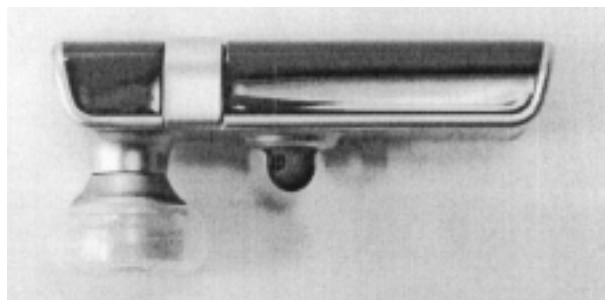
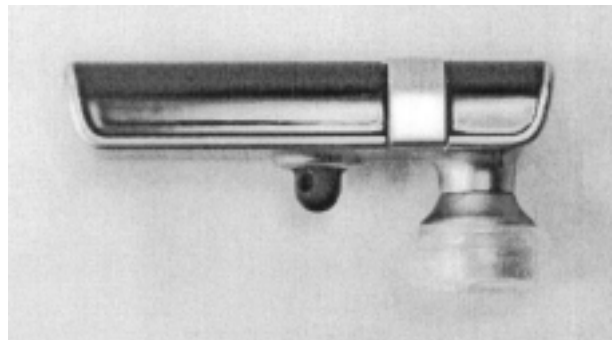
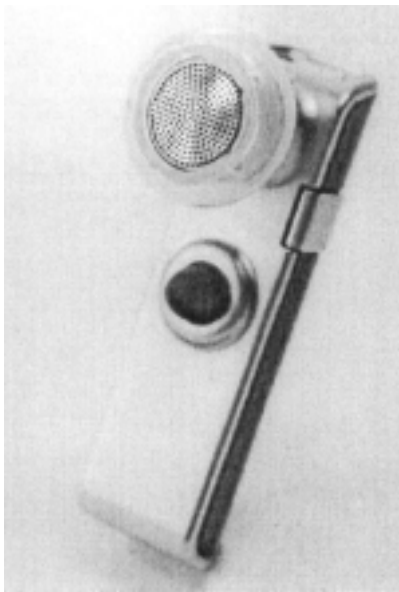
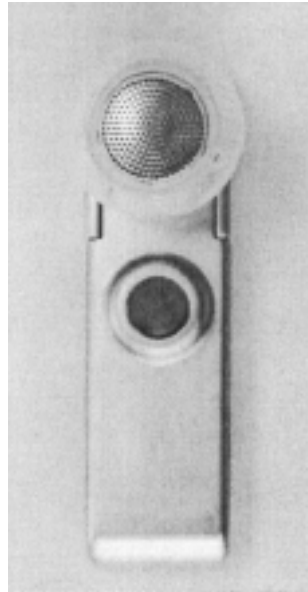

Løbenr. 3



Løbenr. 3

(71) ANSØGER(E): Nokia Corporation, Keilalahdentie 4, FI-02150 Espoo, Finland  
(74) FULDMÆGTIG: Sandel, Løje & Wallberg, Frederiksgade 7, 1265 København K, Danmark  
(72) FREMBRINGER(E): Sami Lehtovaara, Suovasentie 52, FIN-21250 Masku, Finland  
Simon Bradford, 17 York Road, Teddington, Middlesex TW11 8SL, Storbritannien  
(30) PRIORITET: 2007-06-14 FI M20070118  
(22) ANSØGNINGSDATO: 2007-12-14  
(18) GYLDIG TIL: 2012-12-14

(11) DR 2008 00035  
(21) DA 2007 00297

(54) 1) Et hånd sæt 2) hånd sæts frontdække 3) hånd sæts tastaturknapper (51)-Cl.14 03

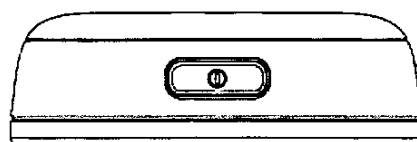
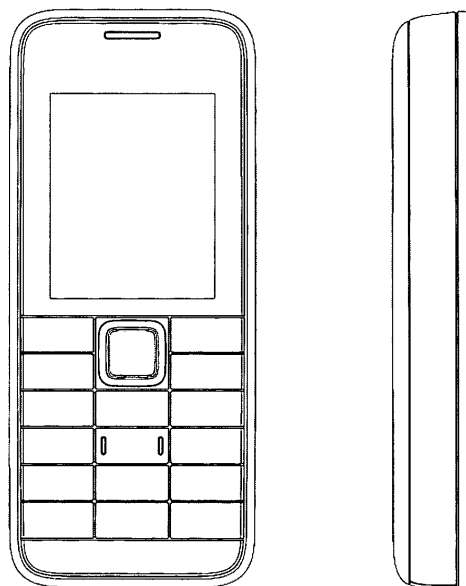
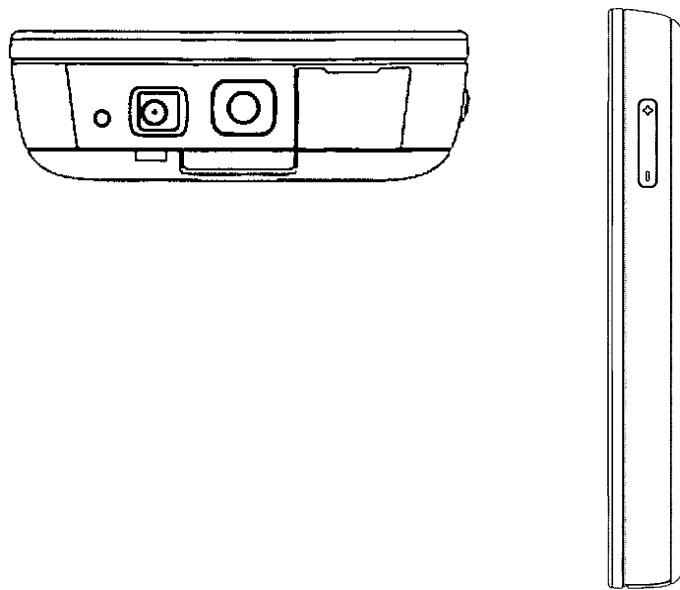

Løbenr. 1

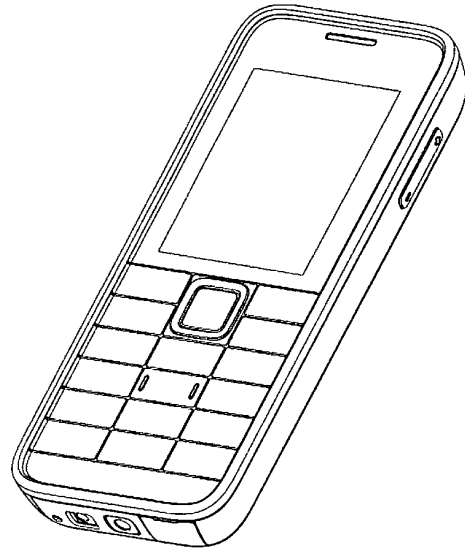
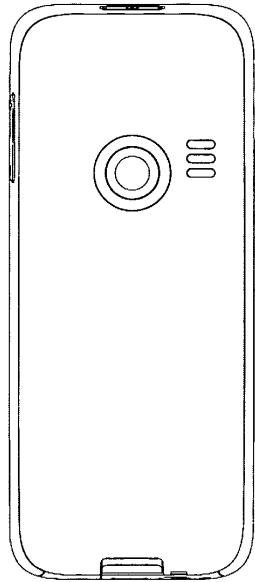

Løbenr. 1

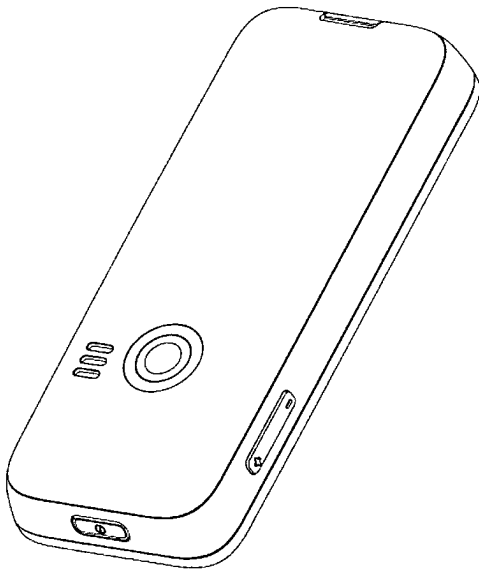

Løbenr. 1

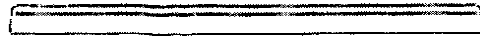

Løbenr. 2



Løbenr. 2

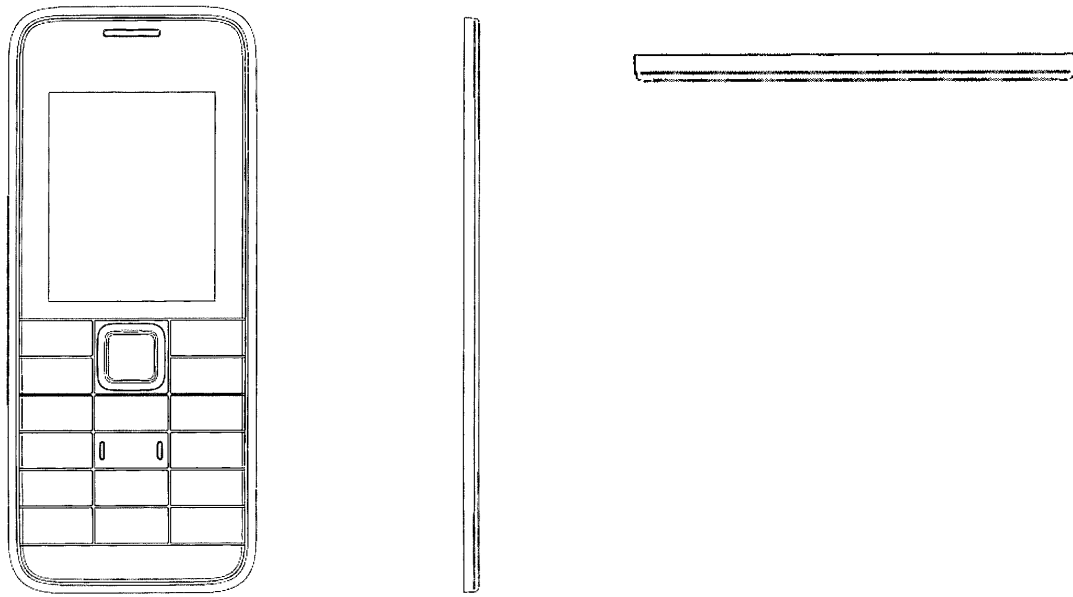

Løbenr. 2

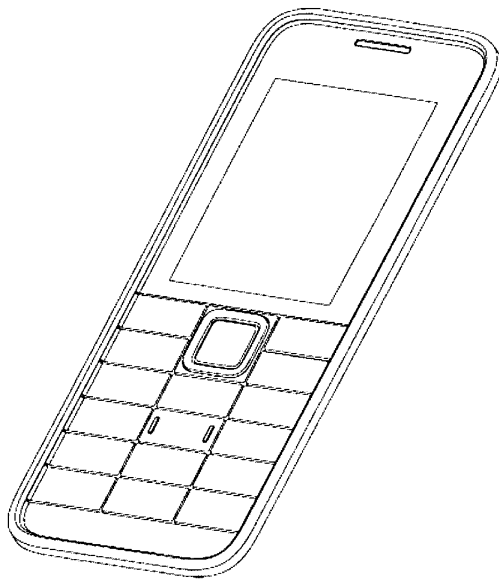

Løbenr. 2

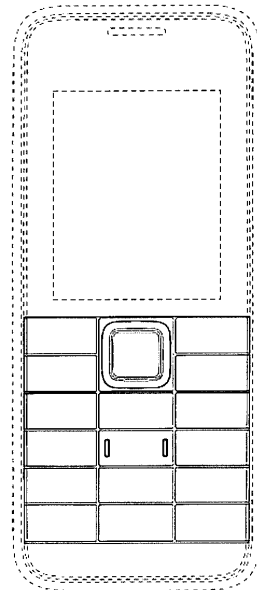

Løbenr. 3

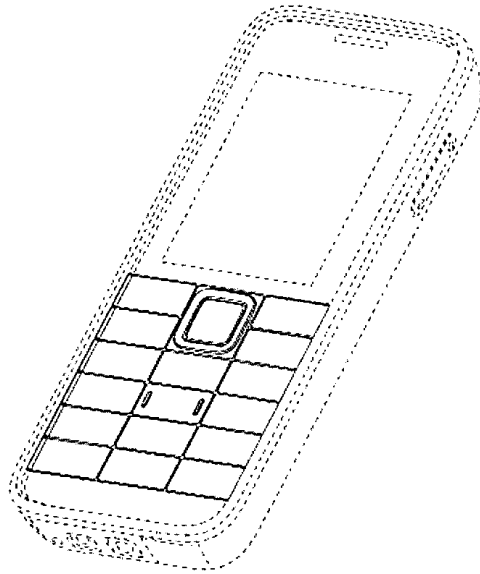

Løbenr. 3

(71) ANSØGER(E): Nokia Corporation, Keilalahdentie 4, FI-02150 Espoo, Finland  
(74) FULDMÆGTIG: Sandel, Løje & Wallberg, Frederiksgade 7, 1265 København K, Danmark  
(72) FREMBRINGER(E): Lee Irvine (U.K. Citizen), The Appleloft, Punchbowl Farm, Thursley, Surrey GU8 &QJ, Storbritannien  
Damian Mycraft (U.K. citizen), 8 Chestnut Sq, Warwick CV35 9QR, Storbritannien  
(30) PRIORITET: 2007-06-14 FI M20070117  
(22) ANSØGNINGSDATO: 2007-12-14  
(18) GYLDIG TIL: 2012-12-14

(11) DR 2008 00036  
(21) DA 2007 00305

(54) 1) Et håndsæt, 2) et håndsæts frontdel, 3) et håndsæts tastaturknapper

(51)-Cl.14 03

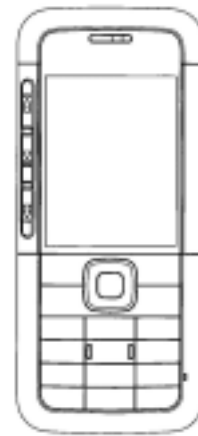

Løbenr. 1



Løbenr. 1



Løbenr. 2

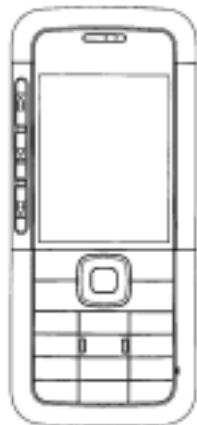
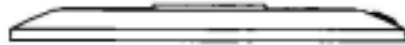

Løbenr. 2

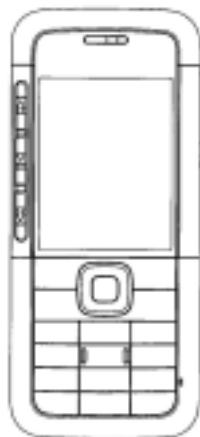
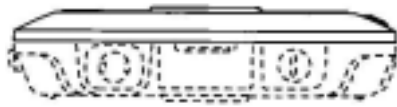
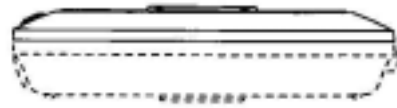

Løbenr. 2



Løbenr. 2

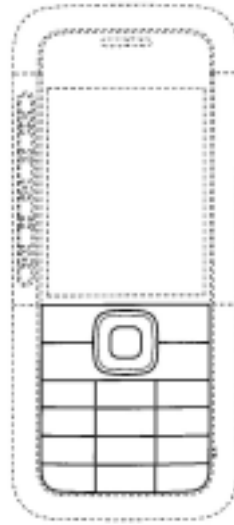

Løbenr. 3



Løbenr. 3

(71) ANSØGER(E): Nokia Corporation, Keilalahdentie 4, FI-02150 Espoo, Finland  
(74) FULDMÆGTIG: Sandel, Løje & Wallberg, Frederiksgade 7, 1265 København K, Danmark  
(72) FREMBRINGER(E): Adam Stone, Fiat 29, Benyon Wharf, 295 Kingsland Road, E8 4DQ Hackney, Storbritannien  
(30) PRIORITET: 2007-06-20 FI M20070120  
(22) ANSØGNINGSDATO: 2007-12-19  
(18) GYLDIG TIL: 2012-12-19

## Offentligt tilgængelige designansøgninger og -registreringer

Akterne i nedenstående ansøgninger eller registreringer er tilgængelige for enhver, jf. § 21, stk. 2, i designlov nr. 1259 af 20. december 2000.

### Klasse 7

### Husholdningsartikler (ikke indeholdt i andre klasser)

(21) DA 2007 00193

(71) ANSØGER(E):

(22) ANSØGNINGSDATO:

(54) En stempelkande

Pi-Design AG, Kantonsstrasse 100, CH-6234 Triengen, Schweiz

2007-08-14

## Fornyelse af designregistreringer

Fornyelse af registreringer foretaget i medfør af § 23, stk. 1, i designlov nr. 1259 af 20. december 2000.

(11) Registreringsnummer	(18) Gyldig til
DR 2003 00271	20130201
DR 2003 00357	20130204
DR 2003 00400	20130214
DR 2003 00401	20130214
DR 2003 00402	20130214
DR 2003 00408	20130221
DR 2003 00399	20130214
DR 2003 00120	20130207
DR 2003 00110	20130130
DR 2003 00109	20130130
DR 2003 00128	20130208
DR 2003 00158	20130306
DR 2003 00159	20130306
DR 2003 00368	20130306
DR 2003 00369	20130306
DR 2003 00163	20130307
DR 2003 00339	20130313
DR 2004 00026	20130313
DR 2003 00180	20130314
DR 2003 00388	20130325
DR 2003 00109	20130130
DR 2003 00110	20130130
DR 2003 00187	20130319
DR 2003 00189	20130319
DR 2003 00164	20130213
DR 2003 00254	20130227
DR 2003 00117	20130212
DR 2003 00361	20130310
DR 2003 00305	20130318
DR 2003 00236	20130227
DR 2003 00446	20130220
DR 2003 00459	20130428

## Udslettede registreringer

Udslettede registreringer foretaget i medfør af designlov nr. 1259 af 20. december 2000.

(11) DR 2002 00693  
(11) DR 2002 00604  
(11) DR 2003 00017  
(11) DR 2003 00016  
(11) DR 2002 00546  
(11) DR 2002 00828  
(11) DR 2002 00547  
(11) DR 2002 00433  
(11) DR 2002 00550  
(11) DR 2002 00658  
(11) DR 2002 00440  
(11) DR 2002 00769  
(11) DR 2002 00445  
(11) DR 2002 00447  
(11) DR 2002 00448  
(11) DR 2002 00449  
(11) DR 2002 00463  
(11) DR 2002 00534  
(11) DR 2002 00462  
(11) DR 2002 00641  
(11) DR 2002 00496  
(11) DR 2002 00471  
(11) DR 2002 00484  
(11) DR 2002 00525  
(11) DR 2002 00620  
(11) DR 2002 00790  
(11) DR 2002 00654  
(11) DR 2002 00791  
(11) DR 2002 00792  
(11) DR 2002 00699  
(11) DR 2003 00114  
(11) DR 2003 00141  
(11) DR 2003 00409

Mønster

## Henlagte, afslåede eller tilbagetagne mønsteransøgninger

Henlagte, afslåede eller tilbagetagne mønsteransøgninger, som er offentligt tilgængelige.

(21) Ansøgningsnummer

(44) Bekendtgjort i Tidende nr.

(43) Offentliggjort i tidende

MA 2000 01350

5, 2001

## Ændringer

Ændringer vedrørende retten til mønstret, mønsterhavers navn, bopæl, fulm. m.v.

### Overdragelser:

(11) MR 1995 00797

Til: (71) Ultradent Products, Inc., a corporation of the State of Utah, 505 West 10200 South, South Jordan, Utah 84095, USA

## Fornyelse af mønsterregistreringer

Fornyelse af registreringer foretaget i medfør af lov om mønstre nr. 218 af 27. maj 1970.

(11) Registreringsnummer	(18) Gyldig til
MR 1998 00648	20130213
MR 1998 00649	20130213
MR 1999 00063	20130313
MR 1999 00002	20130318
MR 1998 00861	20130320
MR 1998 00723	20130326
MR 1998 00933	20130326
MR 1999 00067	20130331
MR 1998 00862	20130323
MR 1998 00706	20130309
MR 1998 00929	20130317
MR 1998 00930	20130317
MR 1998 00931	20130317
MR 1998 00932	20130317
MR 1998 00714	20130210
MR 1998 00692	20130309
MR 1999 00059	20130226
MR 1999 00058	20130226
MR 1998 00695	20130310
MR 1999 00874	20130403
MR 1998 00810	20130313

## Udslettelser af registreringer

Udslettelser af registreringer foretaget i medfør af lov om mønstre nr. 218 af 27. maj 1970.

(11) MR 1994 00094  
(11) MR 1993 00875  
(11) MR 1993 00882  
(11) MR 1993 00980  
(11) MR 1995 00808  
(11) MR 1993 00575  
(11) MR 1993 00989  
(11) MR 1993 00990  
(11) MR 1993 00991  
(11) MR 1993 00979  
(11) MR 1993 00997  
(11) MR 1993 01000  
(11) MR 1995 00814  
(11) MR 1997 00966  
(11) MR 1998 00345  
(11) MR 1998 00346  
(11) MR 1998 00109  
(11) MR 1997 00995  
(11) MR 1998 00269  
(11) MR 1998 00114  
(11) MR 1998 00115  
(11) MR 1998 00116  
(11) MR 1998 00117  
(11) MR 1998 00118  
(11) MR 1998 00119  
(11) MR 1998 00120  
(11) MR 1998 00083  
(11) MR 1998 00241  
(11) MR 1998 00242  
(11) MR 1998 00243  
(11) MR 1998 00244  
(11) MR 1998 00245  
(11) MR 1998 00246  
(11) MR 1998 00247  
(11) MR 1998 00248  
(11) MR 1998 00212  
(11) MR 1998 00213  
(11) MR 1998 00214  
(11) MR 1998 00215  
(11) MR 1998 00216  
(11) MR 1998 00217  
(11) MR 1998 00218  
(11) MR 1998 00219  
(11) MR 1998 00220  
(11) MR 1998 00165  
(11) MR 1998 00171

## WIPO Standard 80

# INID-koder

## Internationally agreed Numbers for the Identification of (bibliographic) data (INID)

- (11) Serial number of the registration
- (15) Date of the registration/Date of the renewal
- (17) Expected duration of the registration/  
renewal
- (18) Expected expiration date of the registration/  
renewal
- (21) Serial number of the application
- (22) Date of filing of the application
- (23) Name and place of exhibition, and date on  
which the industrial design was first  
exhibited there (Exhibition priority date)
- (24) Date from which the industrial design right  
has effect
- (29) Indication of the form in which the industrial  
design is filed, e.g. as a reproduction of the  
industrial design or as a specimen thereof
- (30) Data relating to priority under the Paris  
Convention
- (43) Date of publication of the industrial design  
before examination
- (44) Date of publication of the industrial design  
after examination but before registration
- (45) Date of publication of the registered  
industrial design
- (46) Date of expiration of deferment
- (51) International Classification for Industrial  
Designs (class and subclass of the Locarno  
Classification)
- (54) Designation of article(s) or product(s)  
covered by the industrial design or title of  
the industrial design
- (55) Reproduction of the industrial design (e.g.,  
drawing, photograph) and explanations  
relating to the reproduction
- (57) Description of characteristic features of the  
industrial design including indication of  
colors
- (58) Date of recording of any kind of  
amendment in the Register
- (62) Serial number(s) and, if available, filing  
date(s) of application(s), registration(s) or  
document(s) related by division
- (66) Serial number(s) of the application or the  
registration of the design(s), which is(are) a  
variant(s) of the present one
- (71) Name(s) and address(es) of the appli-  
cant(s)
- (72) Name(s) of the creator(s) if known to be  
such
- (73) Name(s) and address(es) of the owner(s)
- (74) Name(s) and address(es) of the  
representative(s)

## Domestic Codes for the Identification of Data

- (DL) Data concerning license
- (DP) Data concerning pawning

## Internationalt vedtagne Numre til Identifikation af Data (INID)

Registreringsnummer  
Registreringsdato/fornyelsesdato  
Forventet registreringsperiode/fornyelsesperiode  
Forventet udløbsdato for registrering/fornyelse

Ansøgningsnummer  
Ansøgningsdato  
Udstillingsnavn og -sted og dato for første udstil-  
ling (udstillingsprioritetsoplysninger)

Indleveringsdato

Angivelse af i hvilken form designet er indleveret,  
fx som en afbildning af designet eller som en  
model heraf  
Oplysninger om prioritet efter Pariserkonventionen

Dato for offentlig tilgængelighed

Bekendtgørelsesdato for ansøgningen

Offentliggørelse af registreringen

Udsættelsesdato  
International klassifikation af design (klasser og  
underklasser i Locarno Klassifikationen)

Vareangivelse/produktangivelse

Afbildninger af designet (fx tegninger, fotografier)  
og forklaringer vedrørende afbildningerne

Beskrivelse af karakteristiske træk vedr. designet,  
herunder angivelse af farver  
Dato for tilførelse til registret

Nummer på hovedansøgning eller udskilt ansøg-  
ning

Numre på beslægtede ansøgninger

Ansøgners navn og -adresse  
Frembringers/designers navn og adresse  
Indehavernavn og -adresse  
Fuldmægtignavn og -adresse

## Interne koder til identifikation af data

Licensoplysninger  
Pantoplysninger  
Oplysninger om konkurs