



PATENT- OG VAREMÆRKESTYRELSEN

Dansk Design- tidende

Indholdsfortegnelse

Designsager

| | |
|---|----|
| Offentliggørelse af designregistreringer | 5 |
| Offentligt tilgængelige designansøgninger | 29 |
| Ændringer til design | 30 |
| Fornyelse af designregistreringer | 31 |
| Udslettelse af designregistreringer | 32 |

Mønstersager

| | |
|--|----|
| Ændringer til mønstre | 35 |
| Fornyelse af mønsterregistreringer | 36 |
| Udslettelse af mønsterregistreringer | 37 |

Dansk Designtidende kan rekvireres som papirkopi for kr. 150 stk. på tlf. 43 50 85 35

Ansvarlig for redaktion: Keld Nymann Jensen
Udgives af Patent- og Varemærkestyrelsen, Helgeshøj Allé 81, 2630 Tåstrup, tlf. 43 50 80 00

ISSN 1601-7374

Design

Offentliggørelse af designregistreringer

Enhver kan anmode om hel- eller delvis udslettelse af en registrering (administrativ prøvning), jf. § 25 i designlov nr. 1259 af 20. december 2000.
En model af designet kan ses i Patent- og Varemærkestyrelsen, hvis det er offentliggjort, at en model er indleveret til styrelsen.
Det er anført, hvis et design er registreret i farve.

(11) DR 2006 00245
(21) DA 2006 00183

(54) En lågløsner

(51)-Cl.07 04

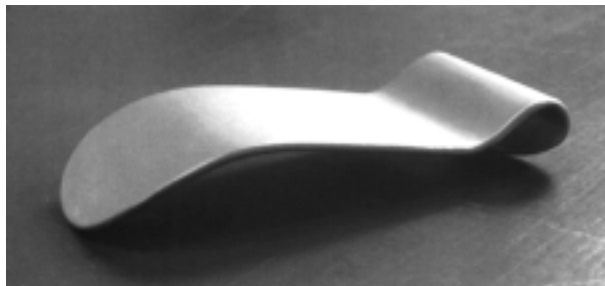

(71) ANSØGER(E):
(22) ANSØGNINGSDATO:
(18) GYLDIG TIL:

Niels Tessing, Prinsessegade 55, 5., 1422 København K, Danmark
2006-07-06
2011-07-06

(11) DR 2006 00246
(21) DA 2006 00272

(54) 1-3) Nisser

(51)-Cl.11 02



(71) ANSØGER(E):
(72) FREMBRINGER(E):
(22) ANSØGNINGSDATO:
(18) GYLDIG TIL:

Enevold Glasværksted v/ Mette Enevold Pinstrup, Møldrupvej 4, 9510 Arden, Danmark
Enevold Glasværksted v/ Mette Enevold Pinstrup, Møldrupvej 4, 9510 Arden, Danmark
2006-10-10
2011-10-10

(11) DR 2006 00247
(21) DA 2006 00148

(54) 1-2) Stempelkander

(51)-Cl.07 04

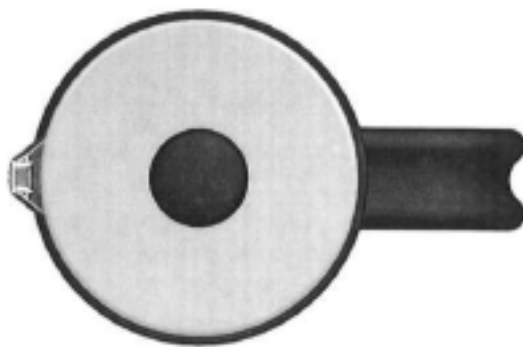
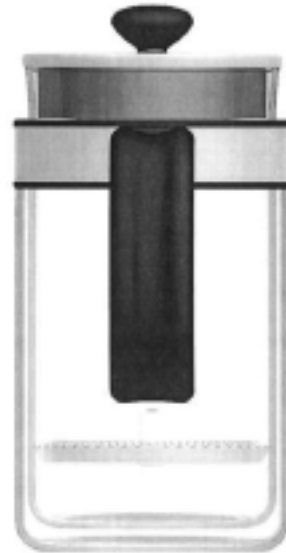



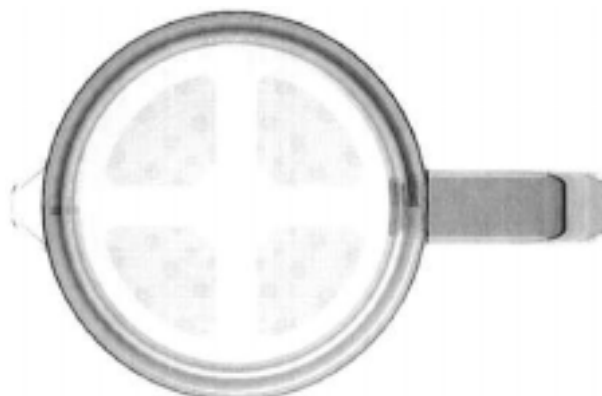
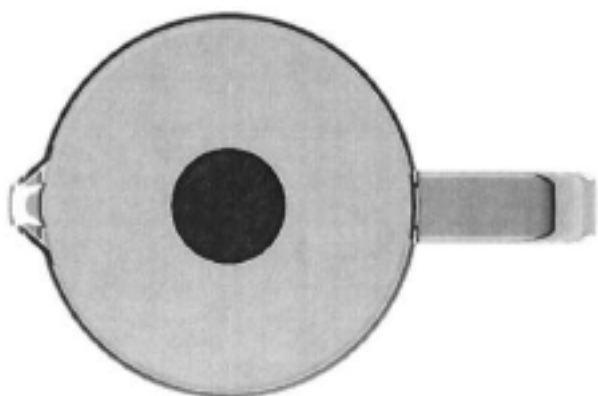

(71) ANSØGER(E): Pi-Design AG, Kantonsstrasse 100, CH-6234 Triengen, Schweiz
(74) FULDMÆGTIG: Gorrissen Federspiel Kierkegaard, H.C. Andersens Boulevard 12, 1553 København V, Danmark
(22) ANSØGNINGSDATO: 2006-06-06
(18) GYLDIG TIL: 2011-06-06

(11) DR 2006 00248
(21) DA 2006 00231

(54) 1-2) Taskeholdere

(51)-Cl.03 99;08 08



(71) ANSØGER(E): Bettina Grønhøj, Asåvej 39, 9220 Aalborg Øst, Danmark
(22) ANSØGNINGSDATO: 2006-08-24
(18) GYLDIG TIL: 2011-08-24

(11) DR 2006 00249
(21) DA 2006 00257

(54) 1) Et håndsæt 2) et håndsæts tastaturknopområde 3) et håndsæts frontdel (51)-Cl.14 03

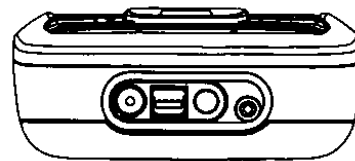
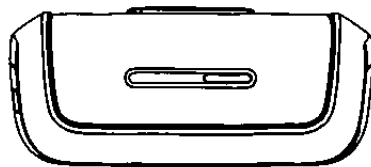
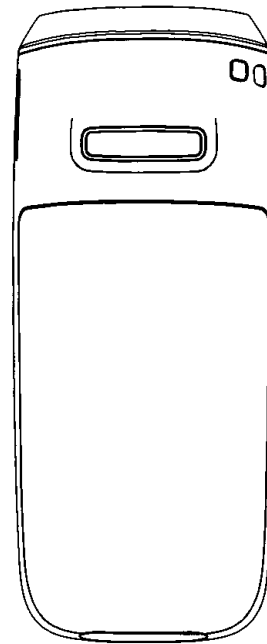
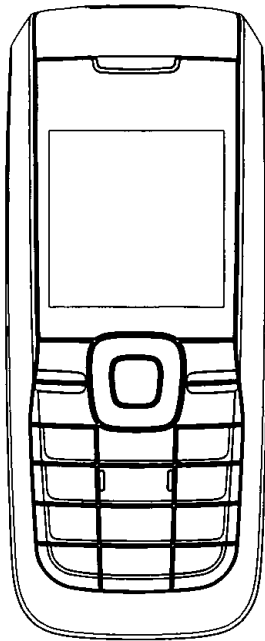

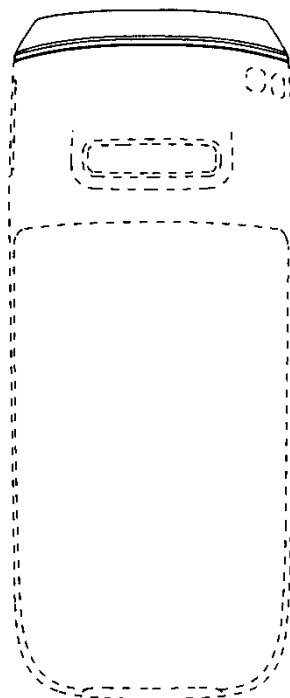
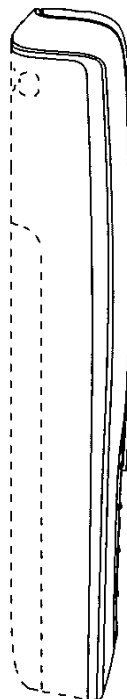
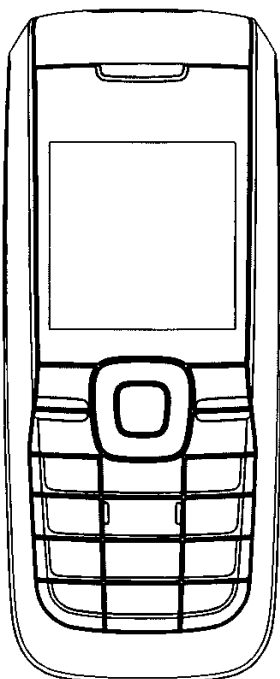
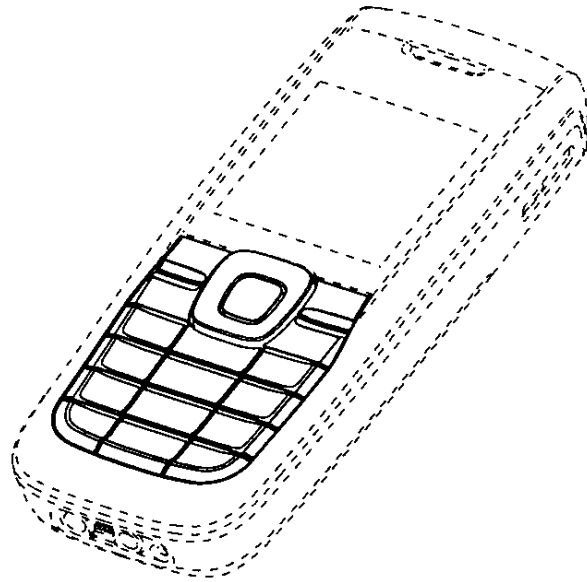
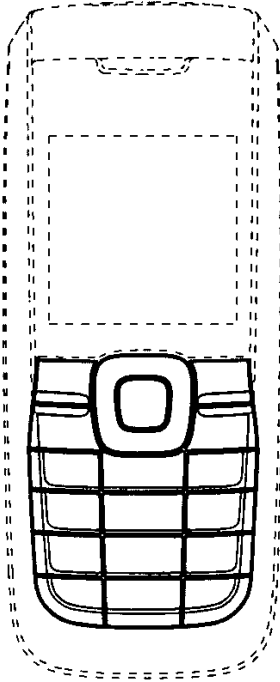
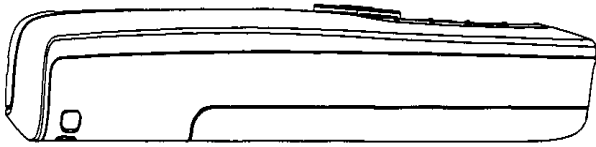

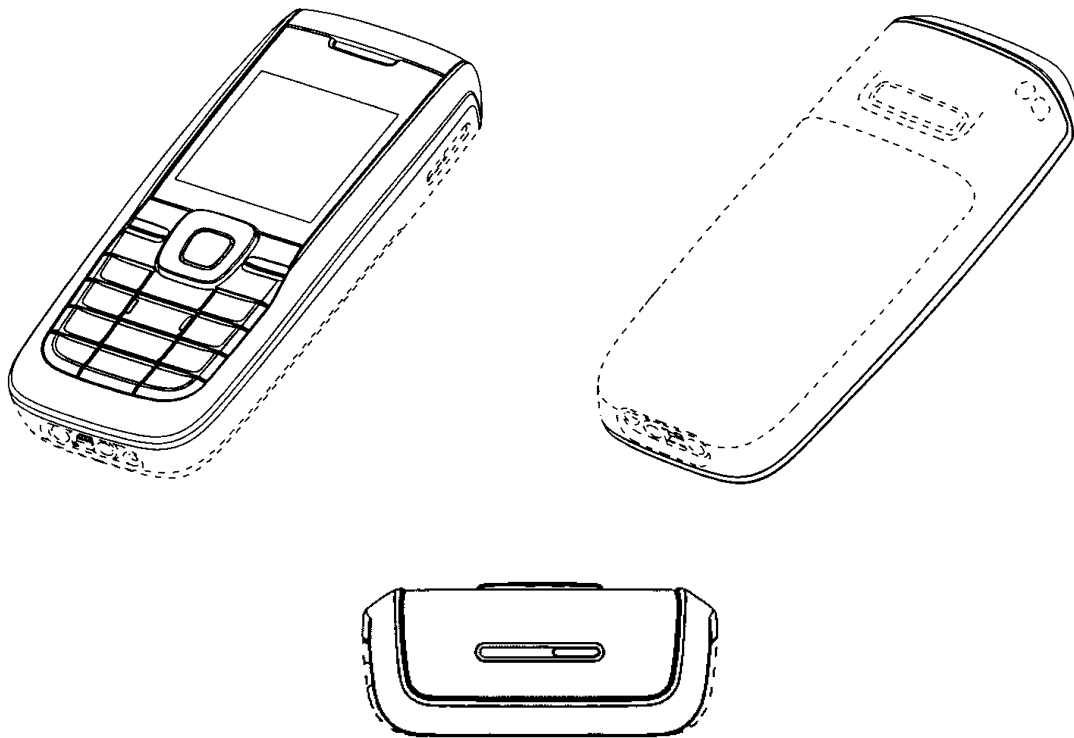

(71) ANSØGER(E): Nokia Corporation, Keilalahdentie 4, FI-02150 Espoo, Finland
(74) FULDMÆGTIG: Sandel, Løje & Wallberg, Frederiksgade 7, 1265 København K, Danmark
(72) FREMBRINGER(E): Wei He, Chegongzhuang West Road 14, 311 Room, Beijing, Kina
(30) PRIORITET: 2006-03-30 FI M20060069
(22) ANSØGNINGSDATO: 2006-09-27
(18) GYLDIG TIL: 2011-09-27

(11) DR 2006 00250

(54) 1) Et håndsæt 2) et håndsæts detaljeområde 3) et håndsæts tastaturknopområde
4) et håndsæts frontdel

(51)-Cl.14 03

(21) DA 2006 00260

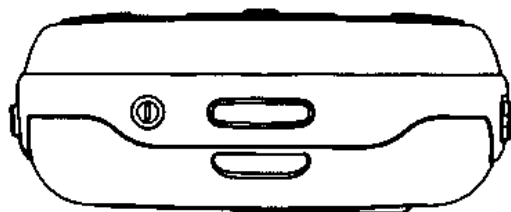
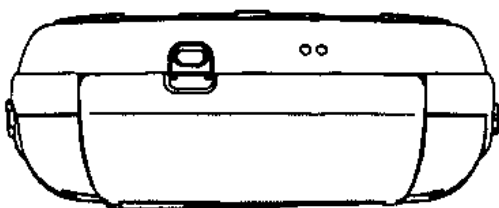
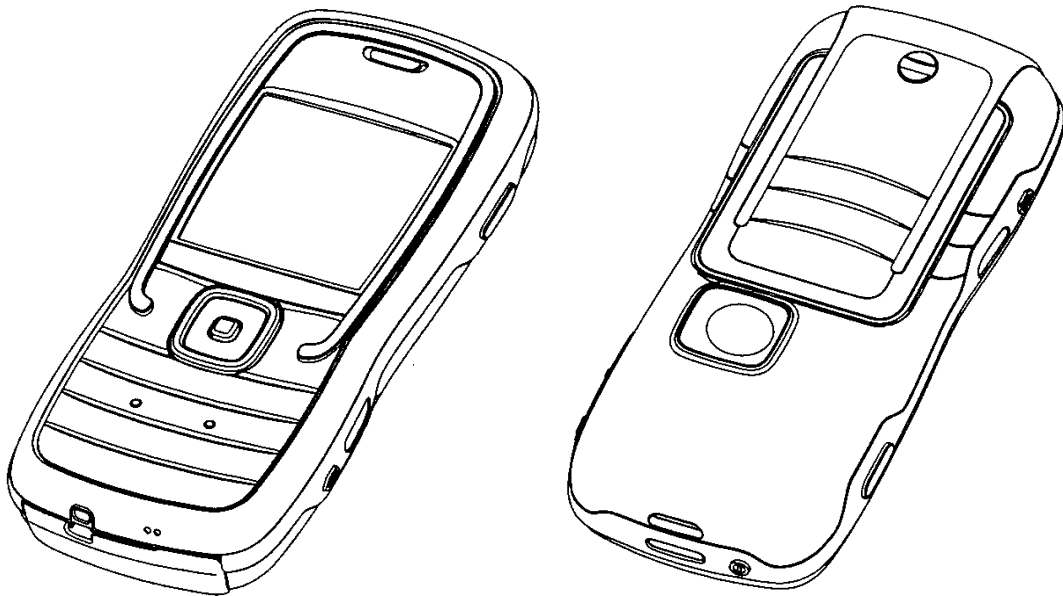
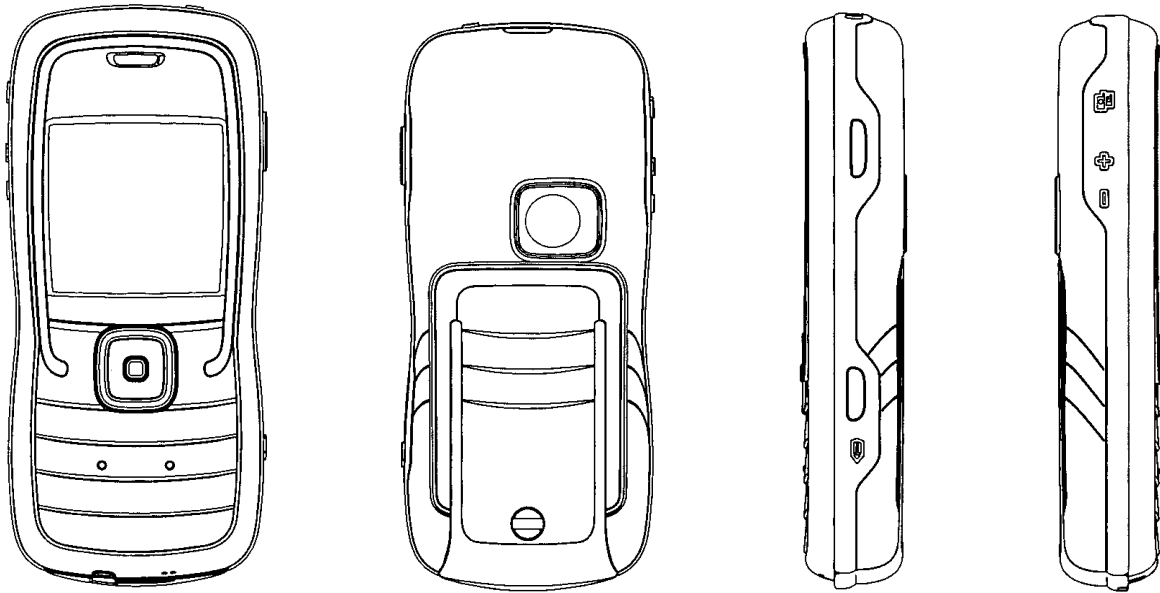

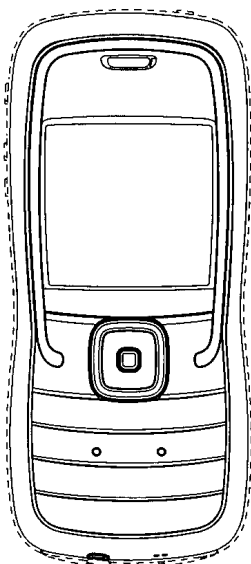
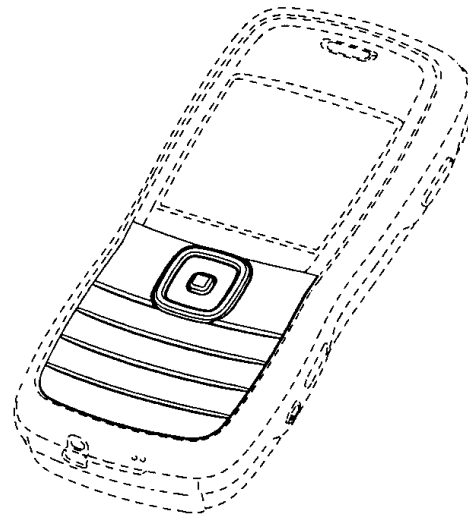
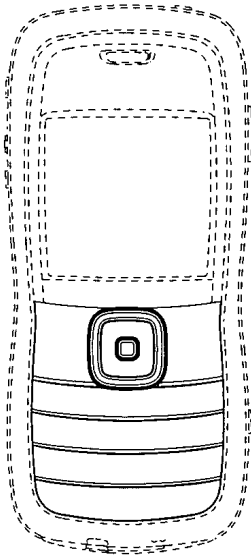
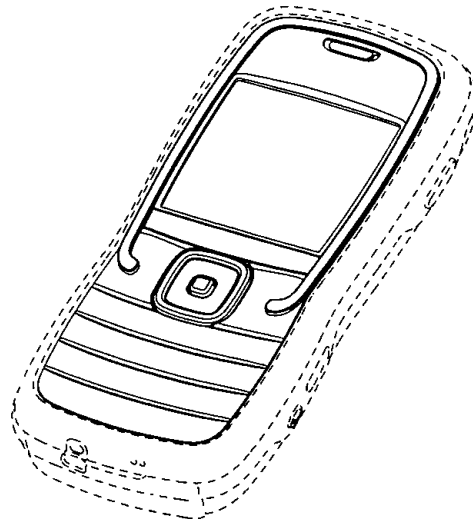
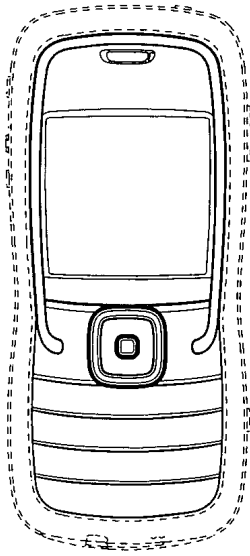

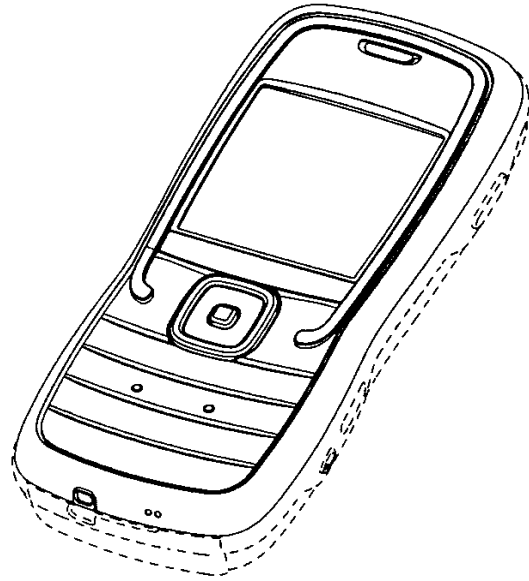
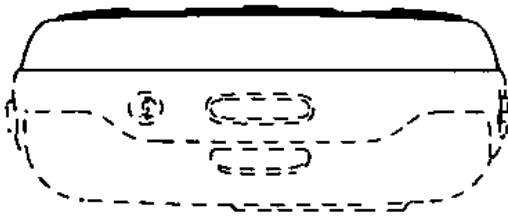

(71) ANSØGER(E): Nokia Corporation, Keilalahdentie 4, FI-02150 Espoo, Finland
(74) FULDMÆGTIG: Sandel, Løje & Wallberg, Frederiksgade 7, 1265 København K, Danmark
(72) FREMBRINGER(E): Kati Björninen, Topeljuksenkatu 19 A 33, FI-00250 Helsinki, Finland
(30) PRIORITET: 2006-04-03 FI M20060074
(22) ANSØGNINGSDATO: 2006-09-28
(18) GYLDIG TIL: 2011-09-28

(11) DR 2006 00251
(21) DA 2006 00261

(54) 1) Et håndsæt 2) et håndsæts tastaturknopområde 3) et håndsæts frontdel (51)-Cl.14 03

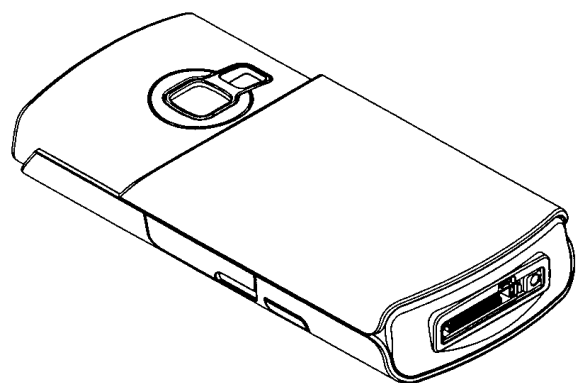
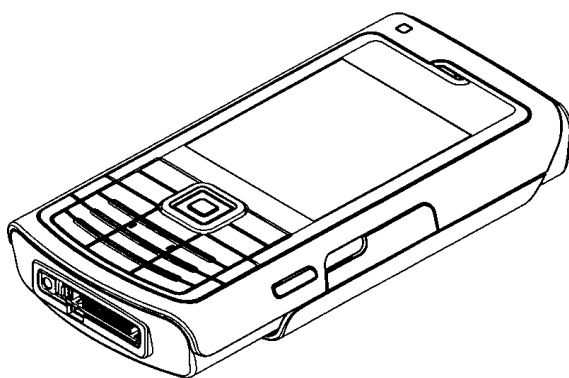
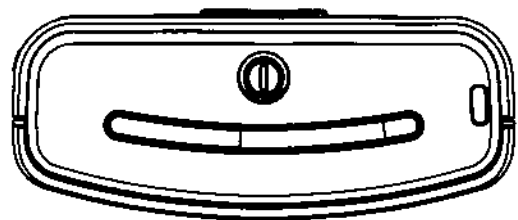
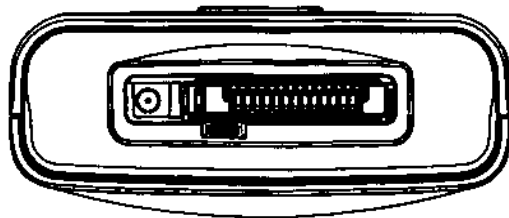
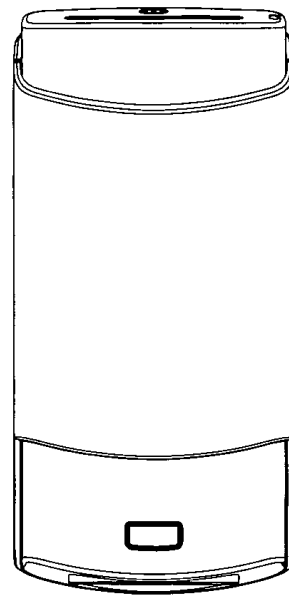
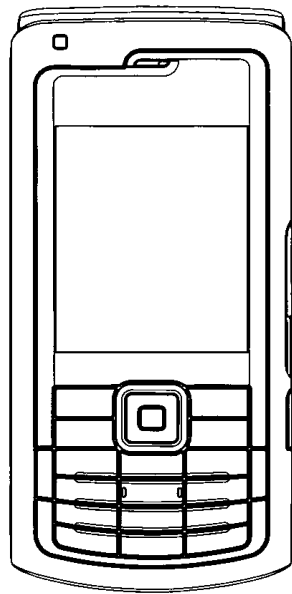

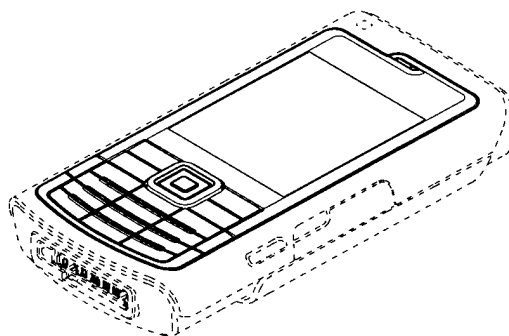
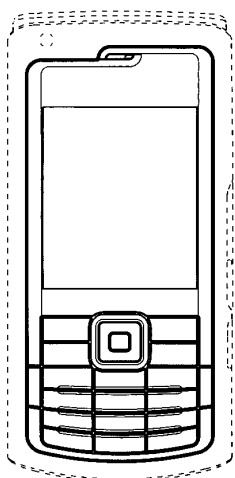
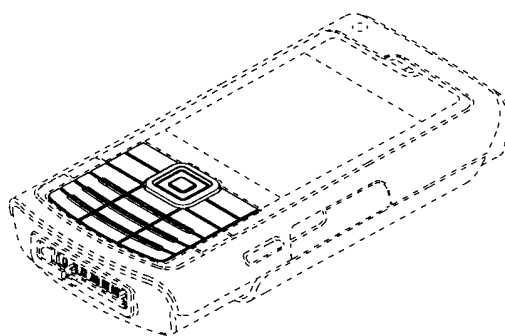
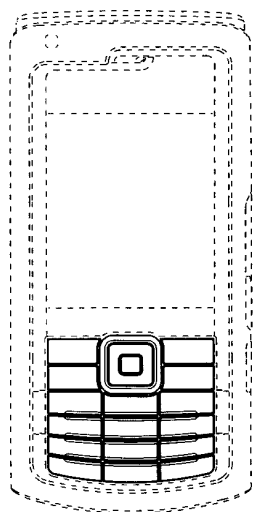
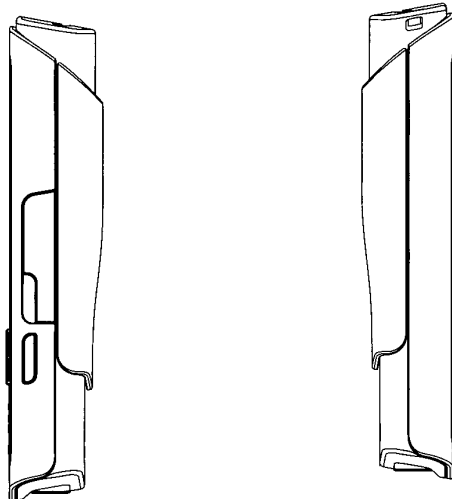

(71) ANSØGER(E):
 (74) FULDMÆGTIG:
 (72) FREMBRINGER(E):

Nokia Corporation, Keilalahdentie 4, FI-02150 Espoo, Finland
 Sandel, Løje & Wallberg, Frederiksgade 7, 1265 København K, Danmark
 Anthony Dalby, 30 Chandos Avenue, Ealing, London W5 4ER, Storbritannien
 Ian Buckie, 8 The Lodge, Glade Mews, Guilford, Surrey, GU1 2EZ, Storbritannien
 2006-04-03 FI M20060075
 (30) PRIORITET:
 (22) ANSØGNINGSDATO:
 (18) GYLDIG TIL:

(11) DR 2006 00252
(21) DA 2006 00262

(54) En lader

(51)-Cl.13 02

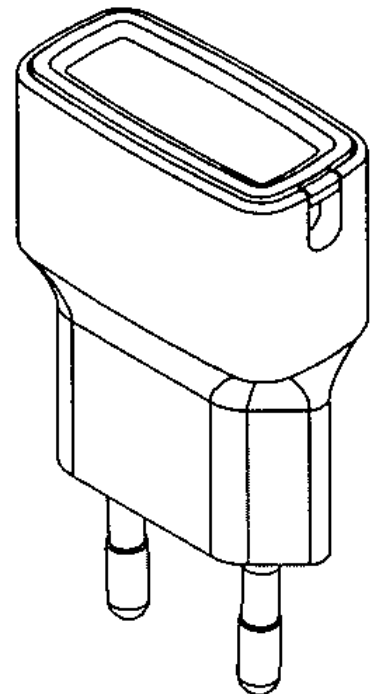
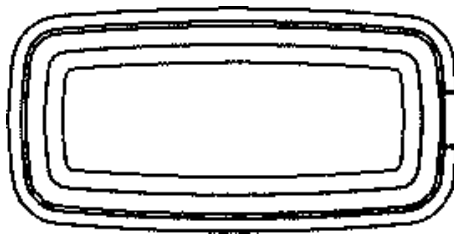
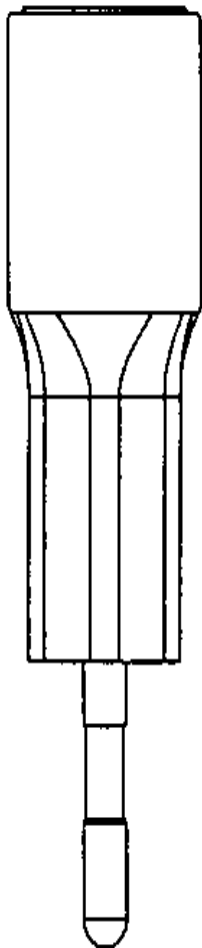
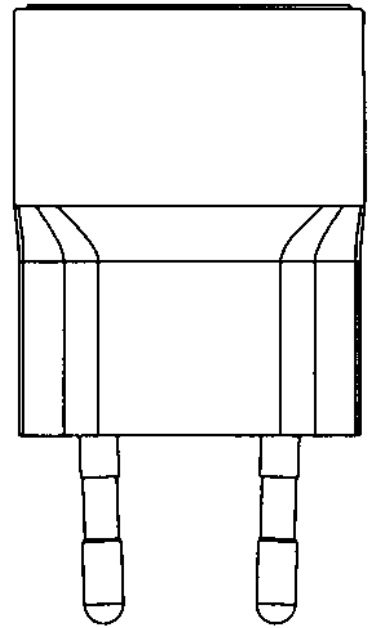
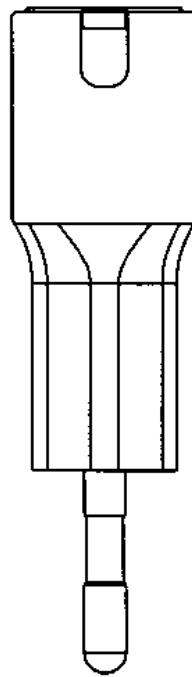
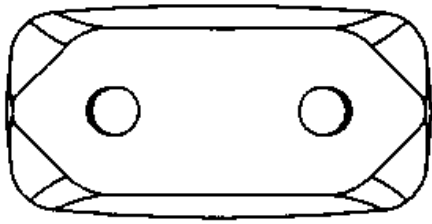

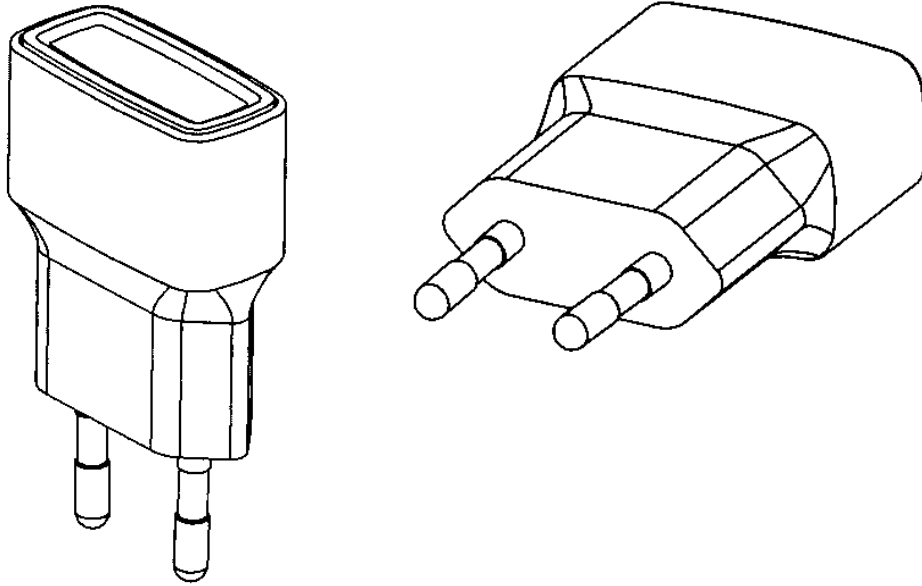

(71) ANSØGER(E): Nokia Corporation, Keilalahdentie 4, FI-02150 Espoo, Finland
(74) FULDMÆGTIG: Sandel, Løje & Wallberg, Frederiksgade 7, 1265 København K, Danmark
(72) FREMBRINGER(E): Janne Loiske, Välppätie 5 b as 40, FI-20540 Turku, Finland
Heli Säde, Liitoskatu 11, FIN-24260 Salo, Finland
(30) PRIORITET: 2006-04-03 FI M20060072
(22) ANSØGNINGSDATO: 2006-09-29
(18) GYLDIG TIL: 2011-09-29

(11) DR 2006 00253
(21) DA 2006 00266

(54) 1) Et håndsæt 2) et håndsæts tastaturknopområde 3) et håndsæts frontdel (51)-Cl.14 03

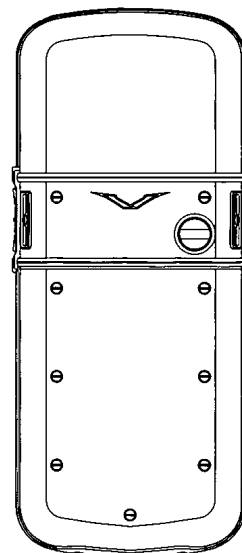
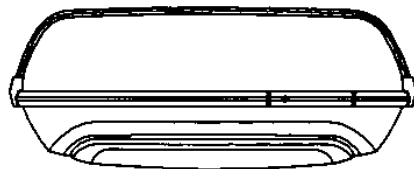
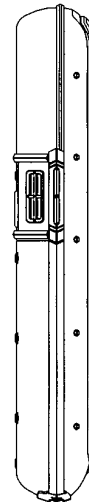
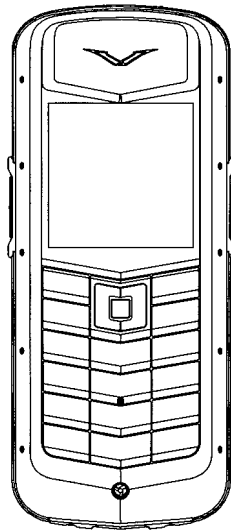
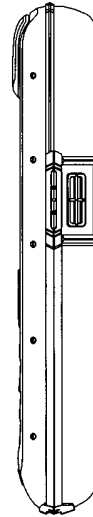
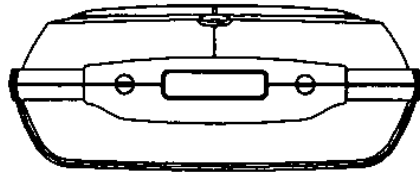

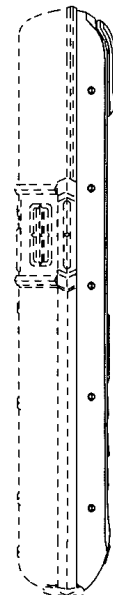
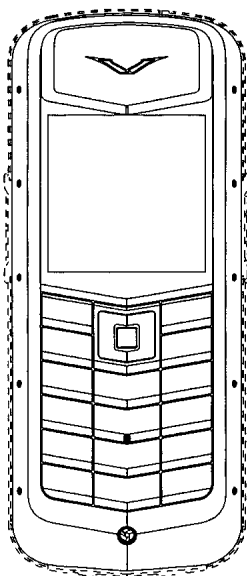
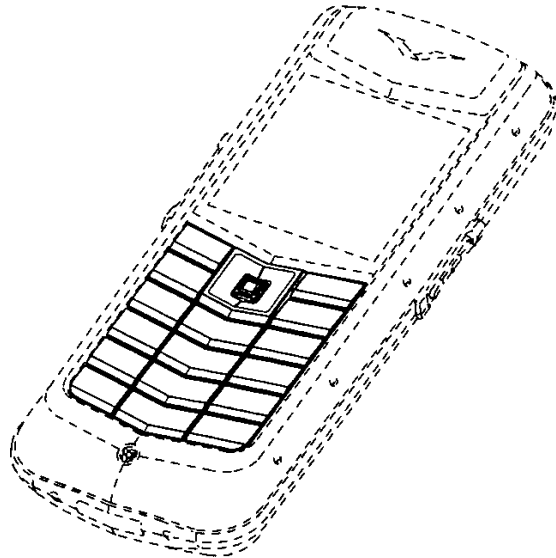
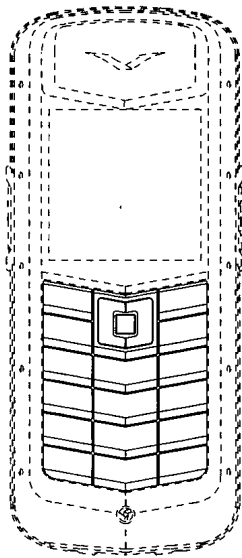
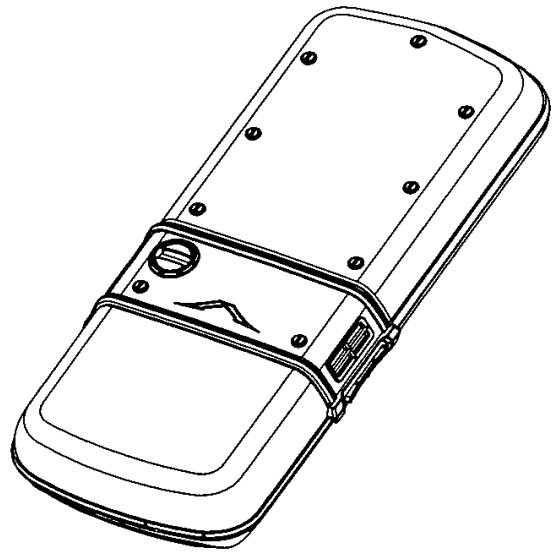
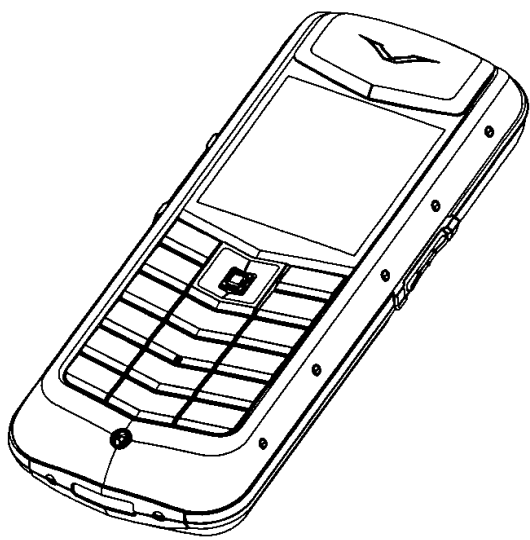

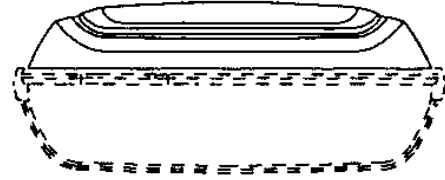
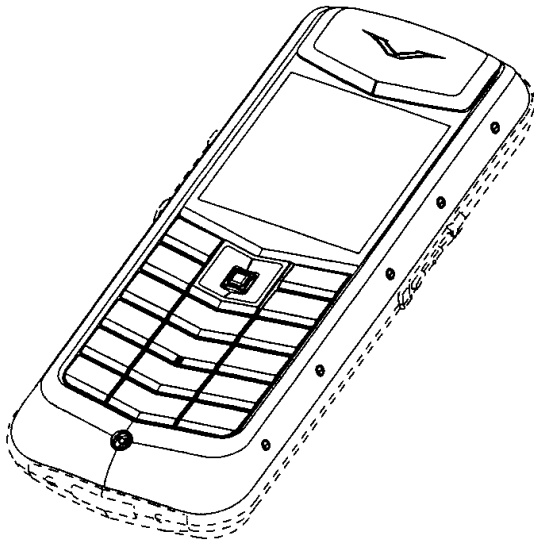

(71) ANSØGER(E): Nokia Corporation, Keilalahdentie 4, FI-02150 Espoo, Finland
 (74) FULDMÆGTIG: Sandel, Løje & Wallberg, Frederiksgade 7, 1265 København K, Danmark
 (72) FREMBRINGER(E): Frank Nuovo, 1612 Stradella Road, Los Angeles, California 90077, USA
 (30) PRIORITET: 2006-04-03 US 29/246.359
 (22) ANSØGNINGSDATO: 2006-10-02
 (18) GYLDIG TIL: 2011-10-02

(11) DR 2006 00254
 (21) DA 2006 00240

(54) En bundgummiliste til tætning ved gulv

(51)-Cl.25 01

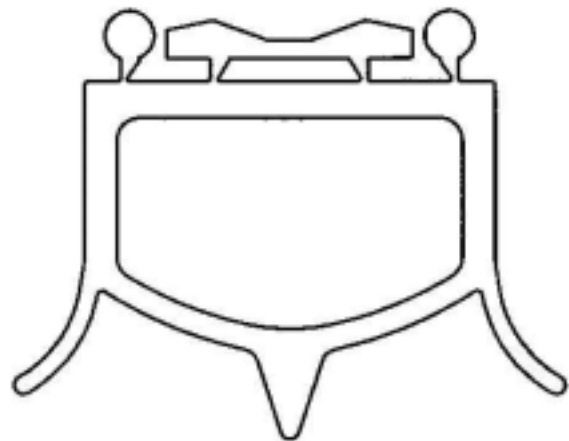
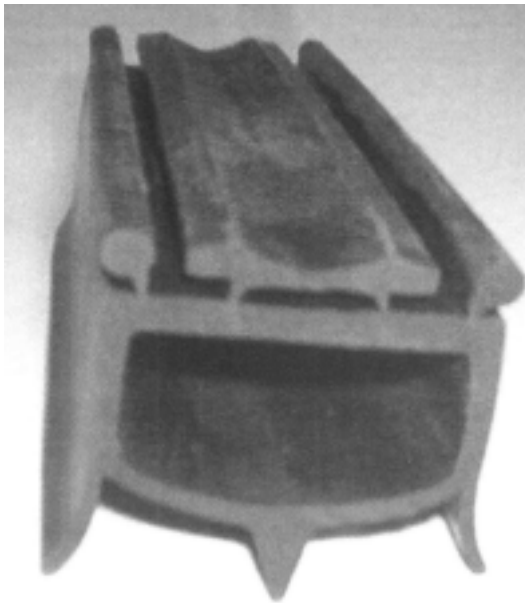

(71) ANSØGER(E): A/S Köpke Porte, Industrivej 1-3, Ølsted, 8723 Løsning, Danmark
 (22) ANSØGNINGSDATO: 2006-09-06
 (18) GYLDIG TIL: 2011-09-06

(11) DR 2006 00255
(21) DA 2006 00256

(54) Et legetøjsfly

(51)-Cl.21 01

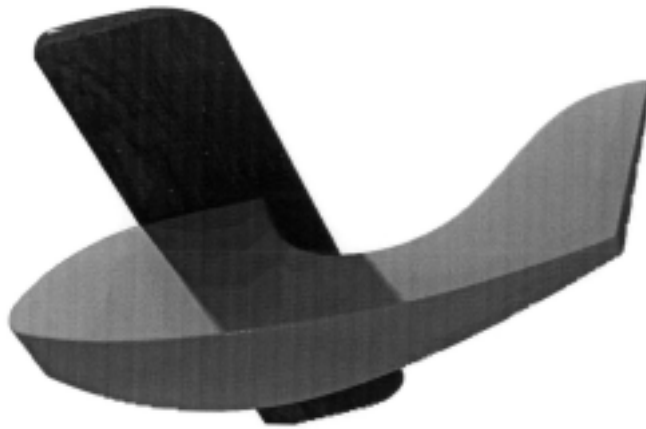

(71) ANSØGER(E):
(22) ANSØGNINGSDATO:
(18) GYLDIG TIL:

Ole Søndergaard ApS, Sct. Anna Gade 71 B, 3000 Helsingør, Danmark
2006-09-27
2011-09-27

(11) DR 2006 00256
 (21) DA 2006 00151

(54) En højttaler

(51)-Cl.14 01

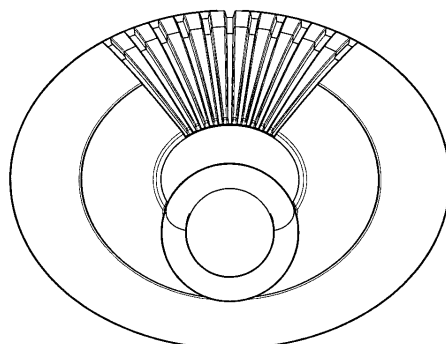
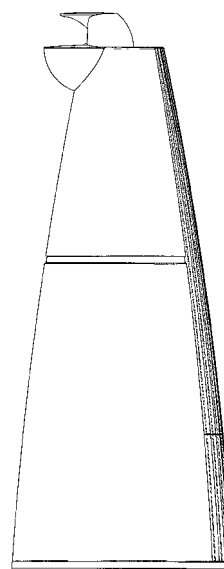
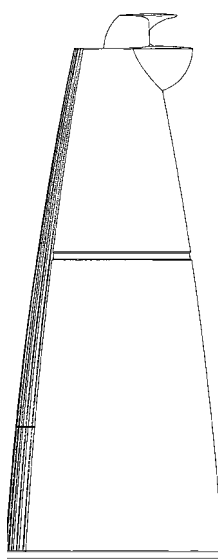
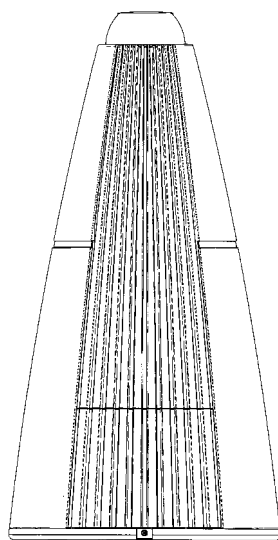
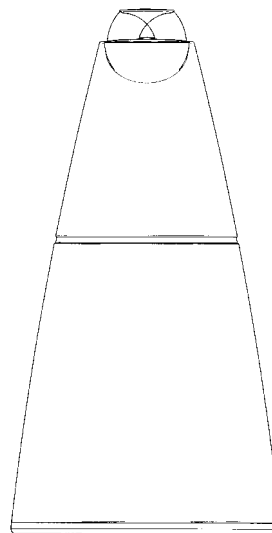
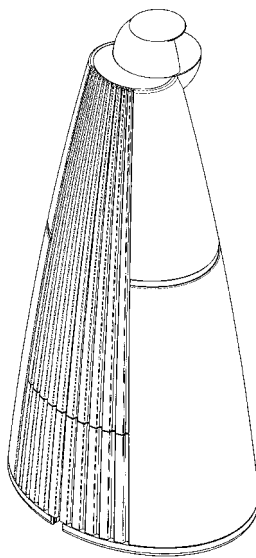
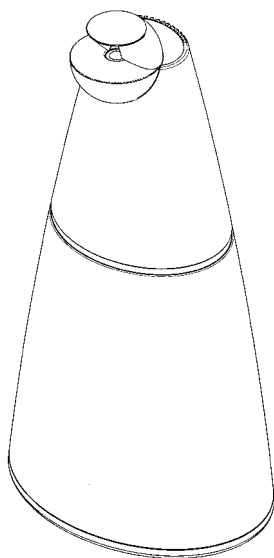

(71) ANSØGER(E):
 (74) FULDMÆGTIG:
 (72) FREMBRINGER(E):
 (22) ANSØGNINGSDATO:
 (18) GYLDIG TIL:

Bang & Olufsen A/S, Peter Bangsvej 15, 7600 Struer, Danmark
 Sandel, Løje & Wallberg, Frederiksgade 7, 1265 København K, Danmark
 David Lewis, Blegdamsvej 28 D, 2200 København N, Danmark
 2006-06-07
 2011-06-07

(11) DR 2006 00257
(21) DA 2006 00269

(54) En kabelskjuler

(51)-Cl.25 01

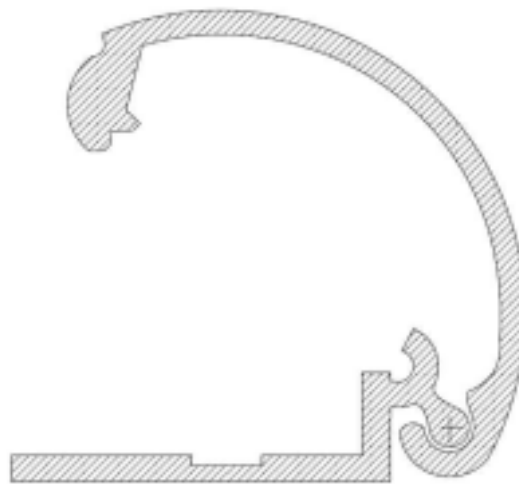
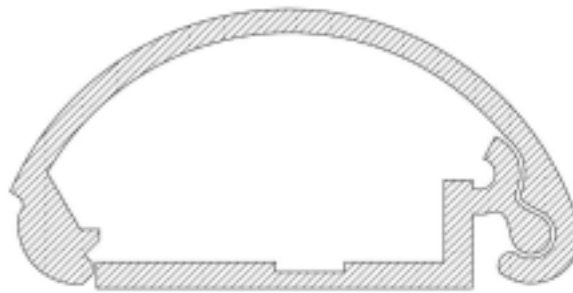
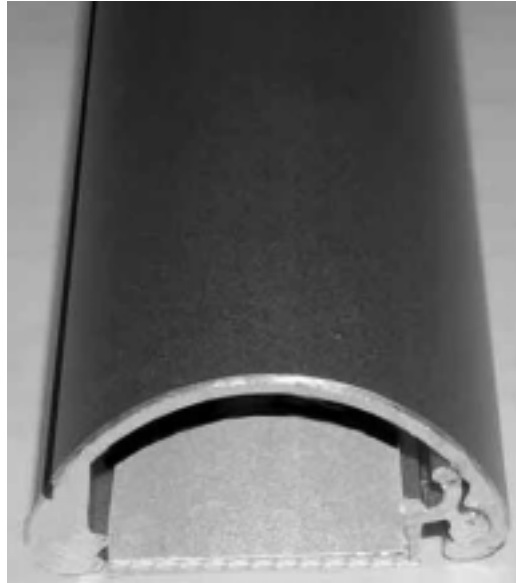

(71) ANSØGER(E):
(72) FREMBRINGER(E):

Claus Gregersen, Engsvinget 46, 8462 Harlev J, Danmark
Claus Gregersen, Engsvinget 46, 8462 Harlev J, Danmark
Michael Vindbæk Kragh, Langelinie 57, Borum, 8471 Sabro, Danmark
Bjarne Gregersen, Engsvinget 46, 8462 Harlev J, Danmark
2006-10-07
2011-10-07

(22) ANSØGNINGSDATO:
(18) GYLDIG TIL:

(11) DR 2006 00258
(21) DA 2006 00324

(54) Et ornament

(51)-Cl.99 00



(71) ANSØGER(E):
(22) ANSØGNINGSDATO:
(18) GYLDIG TIL:

Acer Design v/Erik Simonsen, Østre Havnevej 8-10, 5400 Bogense, Danmark
2006-11-29
2011-11-29

(11) DR 2006 00259
(21) DA 2006 00329

(54) En konditorvare

(51)-Cl.01 01



(71) ANSØGER(E):
(74) FULDMÆGTIG:
(72) FREMBRINGER(E):
(30) PRIORITET:
(22) ANSØGNINGSDATO:
(18) GYLDIG TIL:

Tinus Förtagstjänst AB, Box 514, SE-136 25 Haninge, Sverige
Patrade A/S, Fredens Torv 3 A, 8000 Århus C, Danmark
Peter Lenell, Box 5216, SE-136 25 haninge, Sverige
2006-06-13 SE 79225
2006-12-13
2011-12-13

(11) DR 2006 00260
(21) DA 2006 00327

(54) En skammel

(51)-Cl.06 01

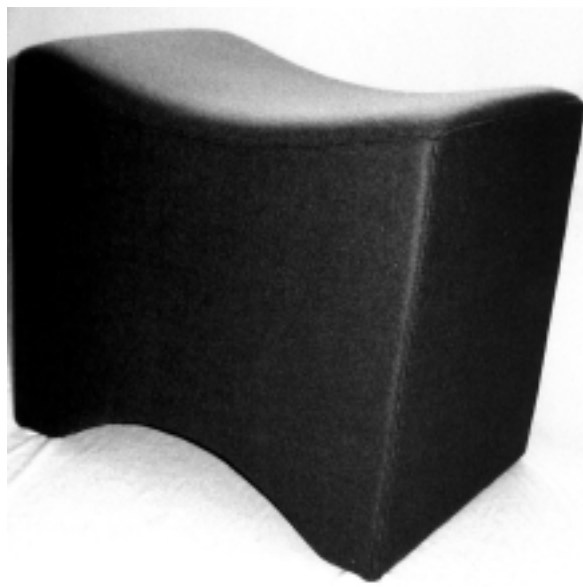
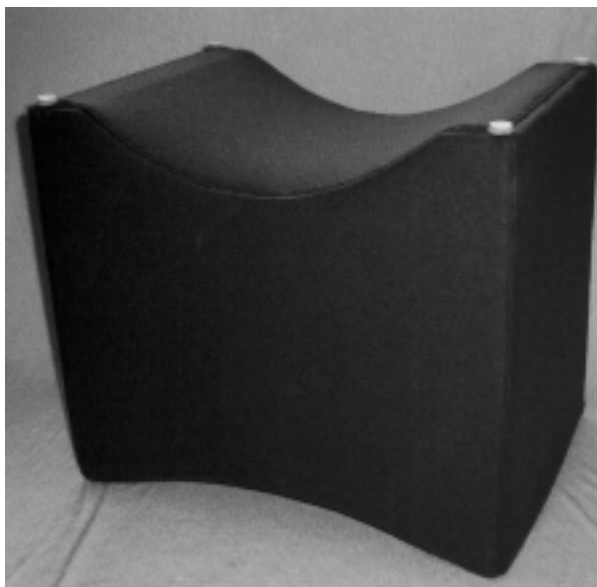

(71) ANSØGER(E):
(22) ANSØGNINGSDATO:
(18) GYLDIG TIL:

Jarl Illum, Th. Brorsensvej 30, st. tv., 6430 Nordborg, Danmark
2006-12-13
2011-12-13

(11) DR 2006 00261
(21) DA 2006 00337

(54) En drikkedunk

(51)-Cl.09 02



(71) ANSØGER(E):
(72) FREMBRINGER(E):
(22) ANSØGNINGSDATO:
(18) GYLDIG TIL:

Off Piste A/S, Bøgeskovvej 18 A, 3490 Kvistgård, Danmark
Off Piste A/S, Bøgeskovvej 18 A, 3490 Kvistgård, Danmark
2006-12-21
2011-12-21

(11) DR 2006 00262
(21) DA 2006 00338

(54) En høj taburet

(51)-Cl.06 01



(71) ANSØGER(E):
(72) FREMBRINGER(E):
(22) ANSØGNINGSDATO:
(18) GYLDIG TIL:

Per Nielsen, Erhvervsvej 8, 9632 Møldrup, Danmark
Per Nielsen, Erhvervsvej 8, 9632 Møldrup, Danmark
2006-12-21
2011-12-21

Offentligt tilgængelige designansøgninger og -registreringer

Akterne i nedenstående ansøgninger eller registreringer er tilgængelige for enhver, jf. § 21, stk. 2, i designlov nr. 1259 af 20. december 2000.

Klasse 1

Næringsmidler

(21) DA 2006 00329
(71) ANSØGER(E):
(30) PRIORITET:
(22) ANSØGNINGSDATO:

(54) En konditorvare
Tinus Förtagstjänst AB, Box 514, SE-136 25 Haninge, Sverige
2006-06-13 SE 79225
2006-12-13

Klasse 7

Husholdningsartikler (ikke indeholdt i andre klasser)

(21) DA 2006 00148
(71) ANSØGER(E):
(22) ANSØGNINGSDATO:

(54) 1-2) Stempelkander
Pi-Design AG, Kantonsstrasse 100, CH-6234 Triengen, Schweiz
2006-06-06

(21) DA 2006 00164
(71) ANSØGER(E):
(22) ANSØGNINGSDATO:

(54) 1) Et krus 2) glas 3) kop
Pi-Design AG, Kantonsstrasse 100, CH-6234 Triengen, Schweiz
2006-06-22

Klasse 14

Udstyr til optagelse og gengivelse af data, telekommunikationsudstyr

(21) DA 2006 00151
(71) ANSØGER(E):
(22) ANSØGNINGSDATO:

(54) En højttaler
Bang & Olufsen A/S, Peter Bangsvej 15, 7600 Struer, Danmark
2006-06-07

(21) DA 2006 00323
(71) ANSØGER(E):
(30) PRIORITET:
(22) ANSØGNINGSDATO:

(54) 1) Et håndsat 2) et håndsets tastaturknopområde 3) et håndsets frontdel
Nokia Corporation, Keilalahdentie 4, FI-02150 Espoo, Finland
2006-06-09 US 29/247,302
2006-12-08

(21) DA 2006 00328
(71) ANSØGER(E):
(30) PRIORITET:
(22) ANSØGNINGSDATO:

(54) 1) Et håndsat 2) et håndsets tastaturknapper 3) et håndsets frontdel
Nokia Corporation, Keilalahdentie 4, FI-02150 Espoo, Finland
2006-06-14 FI M20060130
2006-12-13

Ændringer

Ændringer vedrørende retten til designet, indehaverens navn/firma og adresse, fuldmægtig m.v.

Overdragelser:

(11) DR 2002 00616

Til: (71) Fläkt Woods AB, Sefle, S-551 84 Jönköping, Sverige

Fornyelse af designregistreringer

Fornyelse af registreringer foretaget i medfør af § 23, stk. 1, i designlov nr. 1259 af 20. december 2000.

| (11) Registreringsnummer | (18) Gyldig til |
|--------------------------|-----------------|
| DR 2002 00017 | 20111217 |
| DR 2002 00239 | 20111204 |
| DR 2002 00025 | 20111218 |
| DR 2002 00450 | 20120227 |
| DR 2002 00527 | 20120214 |
| DR 2002 00132 | 20120207 |
| DR 2002 00161 | 20120102 |
| DR 2002 00427 | 20120111 |
| DR 2002 00506 | 20120122 |
| DR 2002 00509 | 20120122 |
| DR 2002 00504 | 20120130 |
| DR 2002 00632 | 20120130 |
| DR 2002 00037 | 20111208 |
| DR 2002 00036 | 20120102 |
| DR 2002 00026 | 20120110 |
| DR 2002 00055 | 20120124 |
| DR 2002 00029 | 20120111 |
| DR 2002 00042 | 20120116 |
| DR 2002 00277 | 20120103 |
| DR 2002 00278 | 20120103 |
| DR 2002 00197 | 20120131 |
| DR 2002 00028 | 20120110 |
| DR 2002 00108 | 20111219 |
| DR 2002 00112 | 20111218 |
| DR 2002 00283 | 20111219 |
| DR 2002 00388 | 20111220 |
| DR 2002 00389 | 20111220 |
| DR 2002 00221 | 20111220 |
| DR 2002 00218 | 20111220 |
| DR 2002 00220 | 20111220 |

Udslettede registreringer

Udslettede registreringer foretaget i medfør af designlov nr. 1259 af 20. december 2000.

(11) DR 2002 00022

(11) DR 2002 00033

Mønster

Ændringer

Ændringer vedrørende retten til mønstret, mønsterhavers navn, bopæl, fulm. m.v.

Overdragelser:

(11) MR 2001 01173

Til: (71) Sveico AB, Bårebo, SE-335 91 Gnosjö, Sverige

Fornyelse af mønsterregistreringer

Fornyelse af registreringer foretaget i medfør af lov om mønstre nr. 218 af 27. maj 1970.

(11) Registreringsnummer

(18) Gyldig til

MR 1997 00583
MR 1998 00380
MR 1998 00872
MR 2001 01173
MR 1997 00633
MR 1997 00927
MR 1997 00465

20111202
20120131
20120227
20110813
20120131
20120211
20111220

Udslettelser af registreringer

Udslettelser af registreringer foretaget i medfør af lov om mønstre nr. 218 af 27. maj 1970.

| | |
|--------------------|--------------------|
| (11) MR 1992 01047 | (11) MR 2000 01187 |
| (11) MR 1992 00967 | (11) MR 2001 00007 |
| (11) MR 1992 01050 | (11) MR 2001 00008 |
| (11) MR 1992 01051 | (11) MR 2000 01189 |
| (11) MR 1992 01228 | (11) MR 2001 00448 |
| (11) MR 1992 01052 | (11) MR 2001 00042 |
| (11) MR 1992 01054 | (11) MR 2001 00331 |
| (11) MR 1992 00836 | (11) MR 2001 00043 |
| (11) MR 1992 00837 | (11) MR 2001 00013 |
| (11) MR 1993 00078 | (11) MR 2001 00014 |
| (11) MR 1992 00840 | (11) MR 2001 00044 |
| (11) MR 1992 00842 | (11) MR 2001 00073 |
| (11) MR 1992 00971 | (11) MR 2001 00075 |
| (11) MR 1992 00972 | (11) MR 2001 00076 |
| (11) MR 1993 00114 | (11) MR 2001 00077 |
| (11) MR 1993 00080 | (11) MR 2001 00078 |
| (11) MR 1992 01135 | (11) MR 2001 00205 |
| (11) MR 1992 01136 | (11) MR 2001 01080 |
| (11) MR 1992 01137 | (11) MR 2001 00905 |
| (11) MR 1992 01138 | (11) MR 2001 00961 |
| (11) MR 1992 01139 | (11) MR 2002 00001 |
| (11) MR 1992 01097 | (11) MR 2002 00156 |
| (11) MR 1997 00251 | (11) MR 2002 00157 |
| (11) MR 1993 00273 | (11) MR 2002 00158 |
| (11) MR 1995 01255 | (11) MR 2002 00159 |
| (11) MR 1995 01256 | (11) MR 2002 00160 |
| (11) MR 1996 00304 | (11) MR 2002 00069 |
| (11) MR 1996 00066 | (11) MR 2002 00298 |
| (11) MR 1996 00067 | (11) MR 2001 00962 |
| (11) MR 1996 00068 | (11) MR 2001 01035 |
| (11) MR 1996 00413 | (11) MR 2002 00070 |
| (11) MR 1996 00414 | (11) MR 2002 00100 |
| (11) MR 1996 00251 | (11) MR 2001 00907 |
| (11) MR 1996 00252 | (11) MR 2001 00942 |
| (11) MR 1996 00257 | (11) MR 2001 00943 |
| (11) MR 1995 01262 | (11) MR 2001 01148 |
| (11) MR 1995 01204 | (11) MR 2001 00984 |
| (11) MR 1995 01263 | (11) MR 2001 00908 |
| (11) MR 1995 01264 | (11) MR 2002 00088 |
| (11) MR 1996 00260 | (11) MR 2001 00963 |
| (11) MR 1996 00001 | (11) MR 2001 00964 |
| (11) MR 1996 00261 | (11) MR 2001 00965 |
| (11) MR 1996 00201 | (11) MR 2001 00966 |
| (11) MR 1996 00226 | (11) MR 2001 00967 |
| (11) MR 1996 00862 | (11) MR 2001 01042 |
| (11) MR 1997 00421 | (11) MR 2001 00911 |
| (11) MR 1997 00422 | (11) MR 2001 00912 |
| (11) MR 1996 00893 | (11) MR 2001 00913 |
| (11) MR 1996 01140 | (11) MR 2001 00914 |
| (11) MR 1996 00894 | |
| (11) MR 1997 00175 | |
| (11) MR 1996 00867 | |
| (11) MR 1996 00986 | |
| (11) MR 1997 00019 | |
| (11) MR 1996 00987 | |
| (11) MR 1997 00177 | |
| (11) MR 1996 00898 | |
| (11) MR 1996 00899 | |
| (11) MR 2000 01171 | |
| (11) MR 2001 00693 | |
| (11) MR 2001 00240 | |
| (11) MR 2000 01284 | |
| (11) MR 2000 01285 | |
| (11) MR 2000 01286 | |
| (11) MR 2000 01186 | |
| (11) MR 2000 01414 | |
| (11) MR 2000 01240 | |
| (11) MR 2000 01241 | |
| (11) MR 2000 01242 | |
| (11) MR 2001 00069 | |
| (11) MR 2001 00330 | |
| (11) MR 2000 01264 | |

WIPO Standard 80

INID-koder

Internationally agreed Numbers for the Identification of (bibliographic) data (INID)

- (11) Serial number of the registration
- (15) Date of the registration/Date of the renewal
- (17) Expected duration of the registration/
renewal
- (18) Expected expiration date of the registration/
renewal
- (21) Serial number of the application
- (22) Date of filing of the application
- (23) Name and place of exhibition, and date on
which the industrial design was first
exhibited there (Exhibition priority date)
- (24) Date from which the industrial design right
has effect
- (29) Indication of the form in which the industrial
design is filed, e.g. as a reproduction of the
industrial design or as a specimen thereof
- (30) Data relating to priority under the Paris
Convention
- (43) Date of publication of the industrial design
before examination
- (44) Date of publication of the industrial design
after examination but before registration
- (45) Date of publication of the registered
industrial design
- (46) Date of expiration of deferment
- (51) International Classification for Industrial
Designs (class and subclass of the Locarno
Classification)
- (54) Designation of article(s) or product(s)
covered by the industrial design or title of
the industrial design
- (55) Reproduction of the industrial design (e.g.,
drawing, photograph) and explanations
relating to the reproduction
- (57) Description of characteristic features of the
industrial design including indication of
colors
- (58) Date of recording of any kind of
amendment in the Register
- (62) Serial number(s) and, if available, filing
date(s) of application(s), registration(s) or
document(s) related by division
- (66) Serial number(s) of the application or the
registration of the design(s), which is(are) a
variant(s) of the present one
- (71) Name(s) and address(es) of the appli-
cant(s)
- (72) Name(s) of the creator(s) if known to be
such
- (73) Name(s) and address(es) of the owner(s)
- (74) Name(s) and address(es) of the
representative(s)

Domestic Codes for the Identification of Data

- (DL) Data concerning license
- (DP) Data concerning pawning

Internationalt vedtagne Numre til Identifikation af Data (INID)

Registreringsnummer
Registreringsdato/fornyelsesdato
Forventet registreringsperiode/fornyelsesperiode
Forventet udløbsdato for registrering/fornyelse

Ansøgningsnummer
Ansøgningsdato
Udstillingsnavn og -sted og dato for første udstil-
ling (udstillingsprioritetsoplysninger)

Indleveringsdato

Angivelse af i hvilken form designet er indleveret,
fx som en afbildning af designet eller som en
model heraf
Oplysninger om prioritet efter Pariserkonventionen

Dato for offentlig tilgængelighed

Bekendtgørelsesdato for ansøgningen

Offentliggørelse af registreringen

Udsættelsesdato
International klassifikation af design (klasser og
underklasser i Locarno Klassifikationen)

Vareangivelse/produktangivelse

Afbildninger af designet (fx tegninger, fotografier)
og forklaringer vedrørende afbildningerne

Beskrivelse af karakteristiske træk vedr. designet,
herunder angivelse af farver
Dato for tilførsel til registret

Nummer på hovedansøgning eller udskilt ansøg-
ning

Numre på beslægtede ansøgninger

Ansøgners navn og -adresse
Frembringers/designers navn og adresse
Indehavernavn og -adresse
Fuldmægtignavn og -adresse

Interne koder til identifikation af data

Licensoplysninger
Pantoplysninger
Oplysninger om konkurs