



PATENT- OG VAREMÆRKESTYRELSEN

Dansk Design- tidende

Indholdsfortegnelse

Designsager

Offentliggørelse af designregistreringer	318
Offentligt tilgængelige designansøgninger	347
Fornyelse af designregistreringer	348
Udslettelse af designregistreringer	349

Mønstersager

Ændringer til mønstre	351
Fornyelse af mønsterregistreringer	352
Udslettelse af mønsterregistreringer	353
Rettelse	354

Dansk Designtidende kan rekvireres som papirkopi for kr. 150 stk. på tlf. 43 50 85 35

Ansvarlig for redaktion: Keld Nymann Jensen
Udgives af Patent- og Varemærkestyrelsen, Helgeshøj Allé 81, 2630 Tåstrup, tlf. 43 50 80 00

ISSN 1601-7374

Design

Offentliggørelse af designregistreringer

Enhver kan anmode om hel- eller delvis udslettelse af en registrering (administrativ prøvning), jf. § 25 i designlov nr. 1259 af 20. december 2000. En model af designet kan ses i Patent- og Varemærkestyrelsen, hvis det er offentliggjort, at en model er indleveret til styrelsen. Det er anført, hvis et design er registreret i farve.

(11) DR 2008 00131
(21) DA 2008 00025

(54) Kombineret bygning og husbåd;Komineret bygning og husbåd

(51)-Cl.12 06;25 03

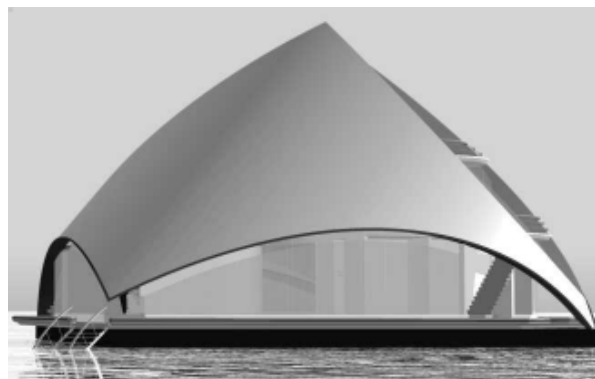
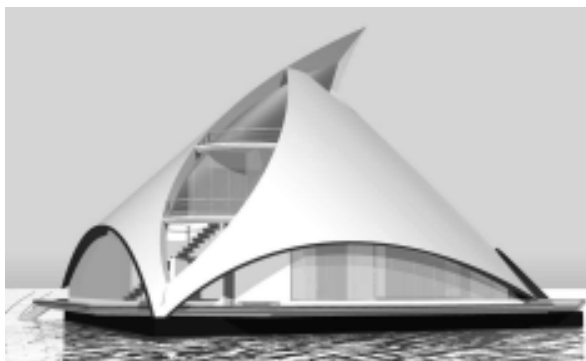

(71) ANSØGER(E):

(72) FREMBRINGER(E):

(22) ANSØGNINGSDATO:

(18) GYLDIG TIL:

Create 2.0 v/Charlotte Meldgaard Moltke, Slotsparken 68, 2880 Bagsværd, Danmark

Ivar Moltke, Slotsparken 68, 2880 Bagsværd, Danmark

Morten Jeppesen, Købmagergade 61, 3., 1150 København K, Danmark

2008-01-31

2013-01-31

(11) DR 2008 00132
(21) DA 2008 00034

(54) 1-2) Krus

(51)-Cl.07 01

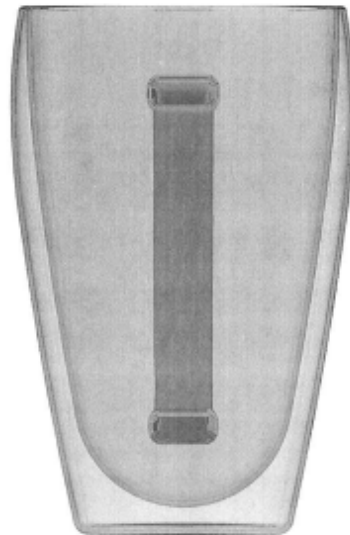
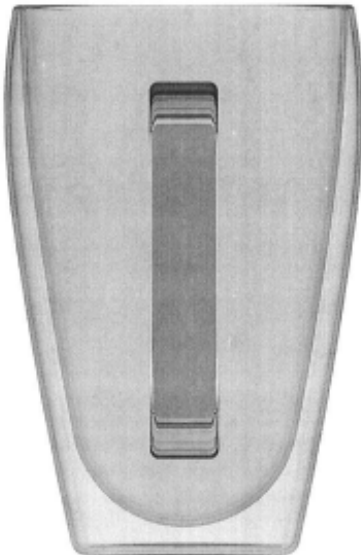
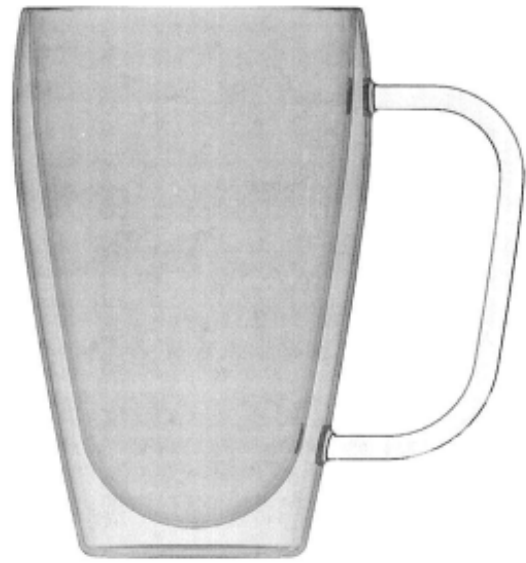
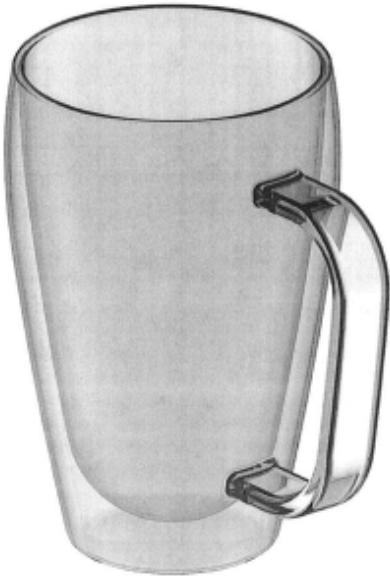

Løbenr. 1

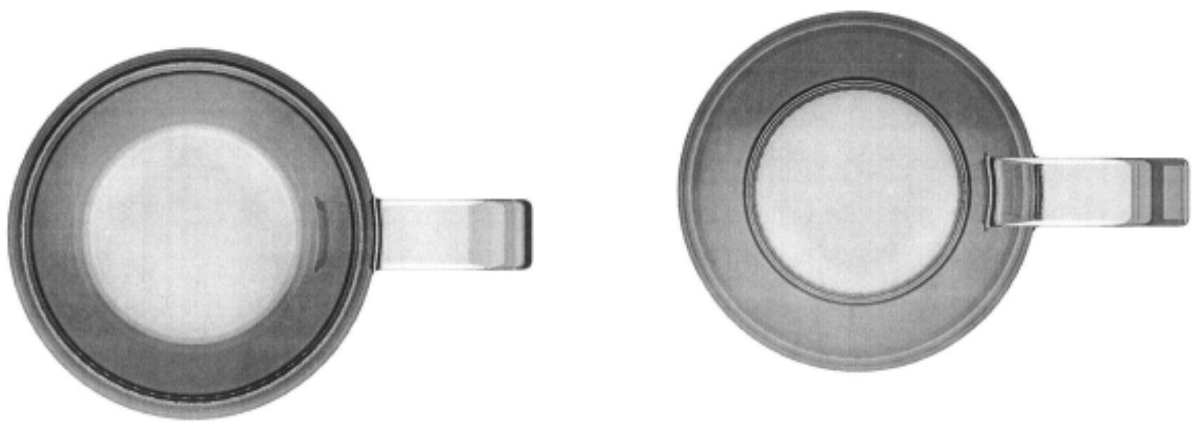

Løbenr. 1



Løbenr. 2

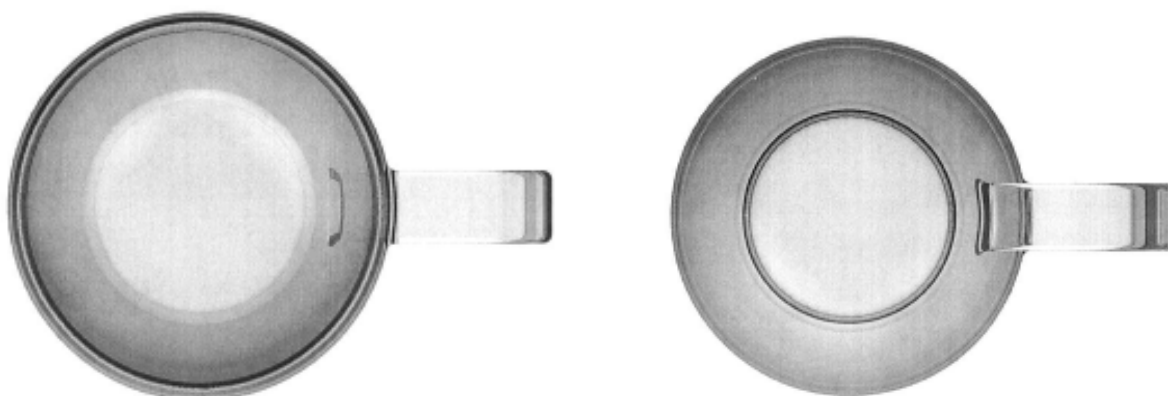

Løbenr. 2

(71) ANSØGER(E): Pi-Design AG, Kantonsstrasse 100, CH-6234 Triengen, Schweiz
(74) FULDMÆGTIG: Gorrissen Federspiel Kierkegaard, H.C. Andersens Boulevard 12, 1553 København V, Danmark
(22) ANSØGNINGSDATO: 2008-02-01
(18) GYLDIG TIL: 2013-02-01

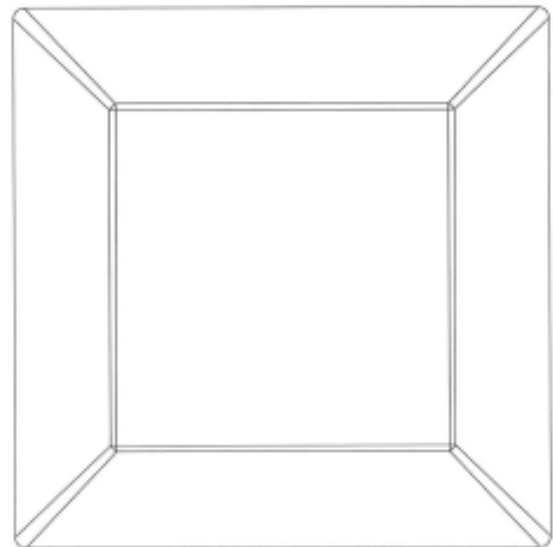
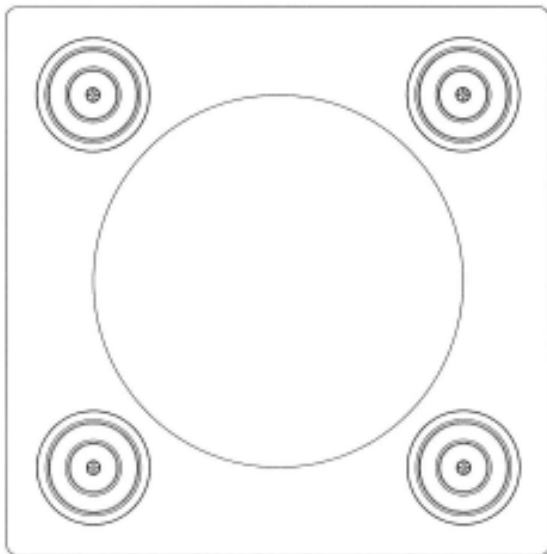
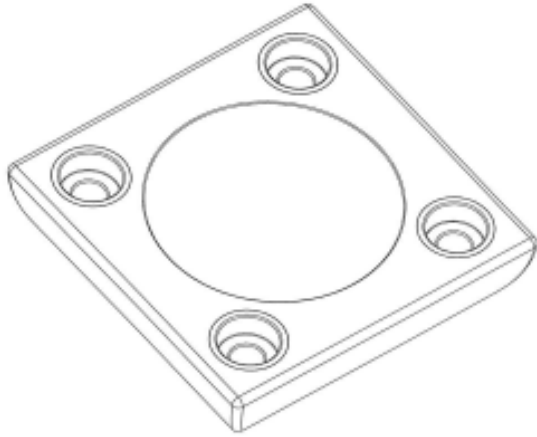

Løbenr. 1

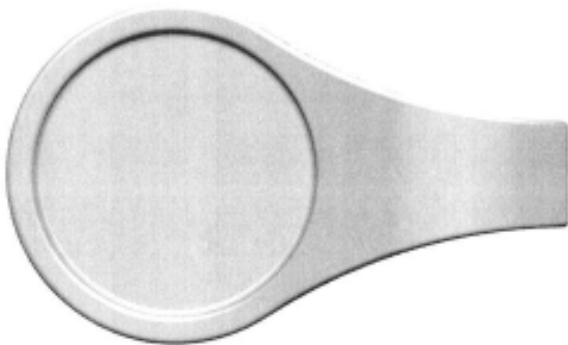
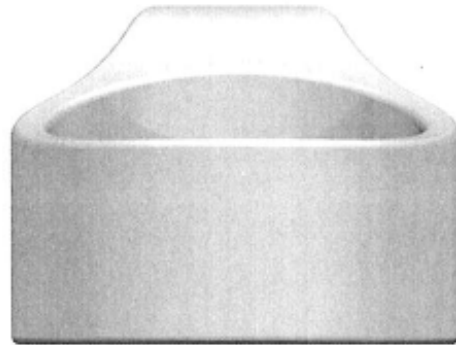
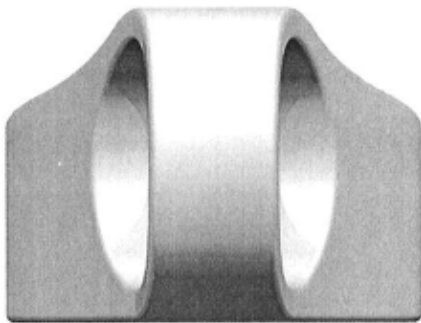
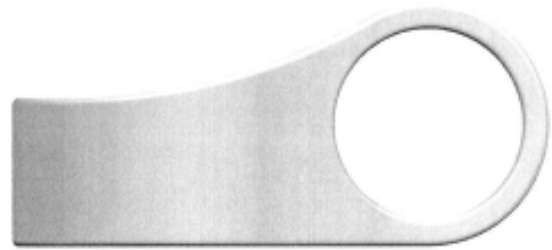

Løbenr. 2

(71) ANSØGER(E):
(74) FULDMÆGTIG:
(22) ANSØGNINGSDATO:
(18) GYLDIG TIL:

Pi-Design AG, Kantonsstrasse 100, CH-6234 Triengen, Schweiz
Gorrissen Federspiel Kierkegaard, H.C. Andersens Boulevard 12, 1553 København V, Danmark
2008-02-05
2013-02-05

(11) DR 2008 00134
(21) DA 2008 00135

(54) En oplukker til drikkedåser

(51)-Cl.07 06



(71) ANSØGER(E):
(22) ANSØGNINGSDATO:
(18) GYLDIG TIL:

Lars Majlund Mørk, Bakkevej 1, 1. 103, 6000 Kolding, Danmark
2008-05-19
2013-05-19

(11) DR 2008 00135
(21) DA 2008 00036

(54) Et nøgleophæng

(51)-Cl.03 01;06 04

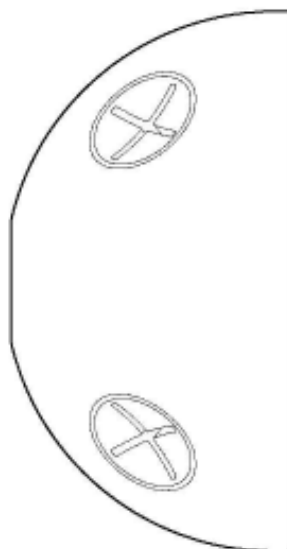
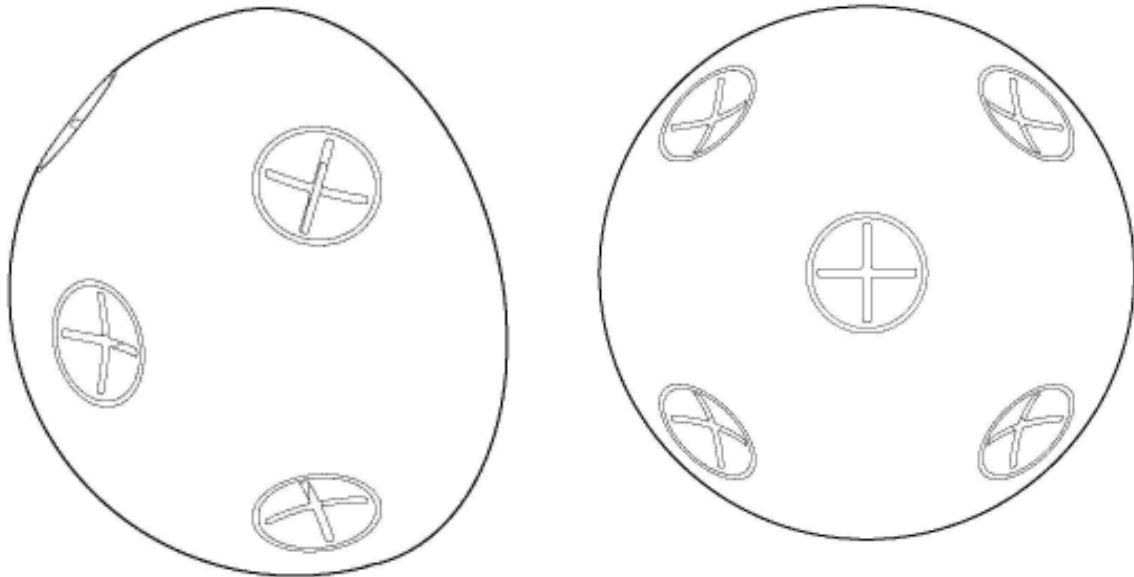

(71) ANSØGER(E):
(72) FREMBRINGER(E):
(22) ANSØGNINGSDATO:
(18) GYLDIG TIL:

DOK 54 ApS, Uhrevej 3, 6064 Jordrup, Danmark
Jacob M. Lund, Dalgade 4a, 6040 Egtved, Danmark
Thomas Brinch-Møller, Slåenvej 45, 7000 Fredericia, Danmark
2008-02-07
2013-02-07

(11) DR 2008 00136
(21) DA 2008 00039

(54) 3) sukkerskål;1-2) Flødekander

(51)-Cl.07 01;07 06

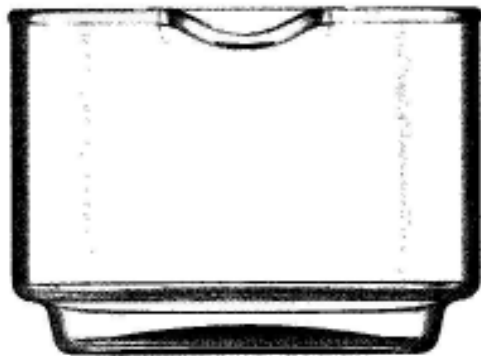

Løbenr. 1

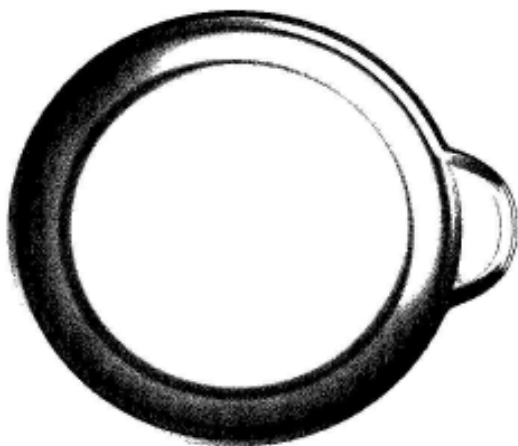
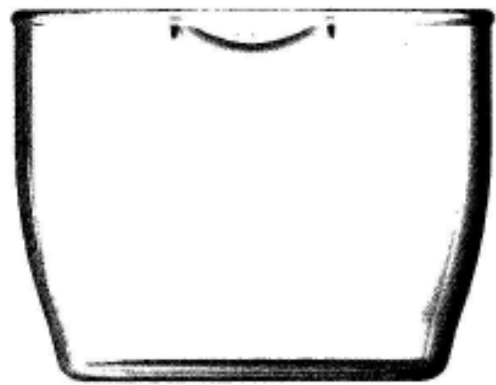
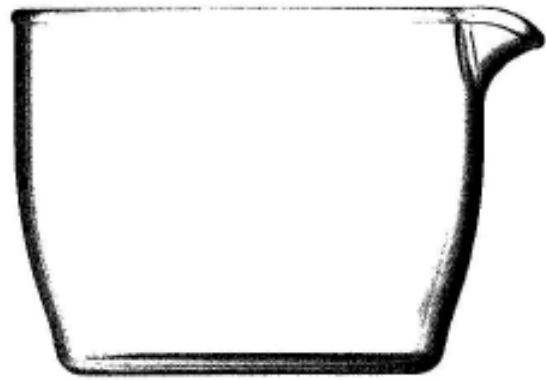

Løbenr. 2

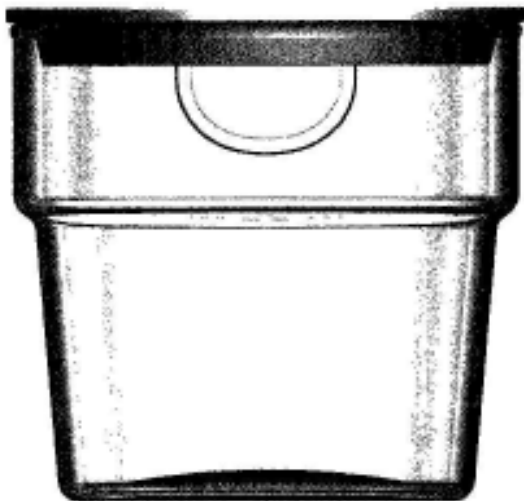
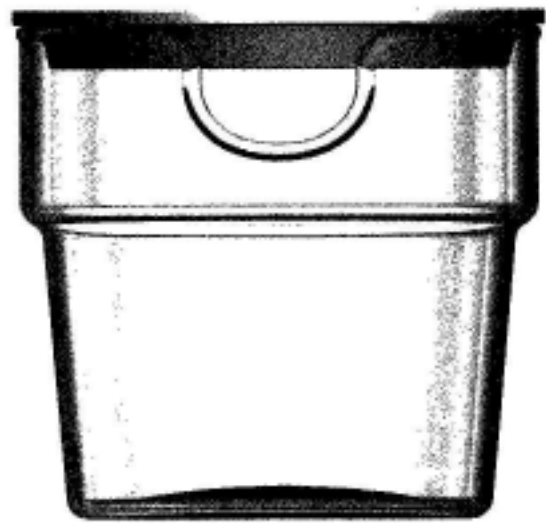

Løbenr. 3

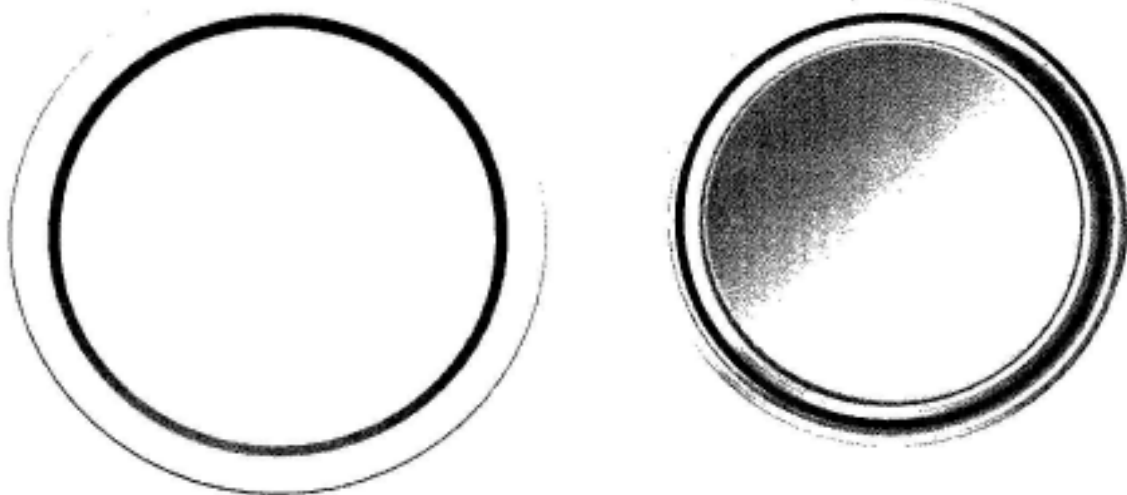

Løbenr. 3

(71) ANSØGER(E): Pi-Design AG, Kantonsstrasse 100, CH-6234 Triengen, Schweiz
(74) FULDMÆGTIG: Gorrissen Federspiel Kierkegaard, H.C. Andersens Boulevard 12, 1553 København V, Danmark
(22) ANSØGNINGSDATO: 2008-02-07
(18) GYLDIG TIL: 2013-02-07

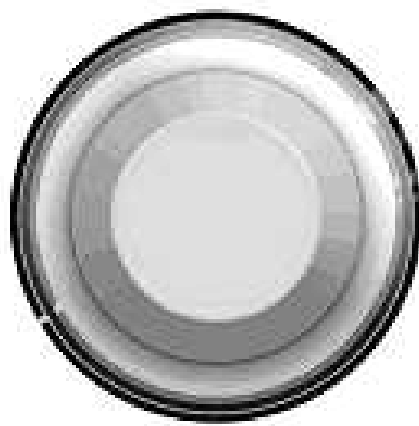

Løbenr. 1



Løbenr. 2

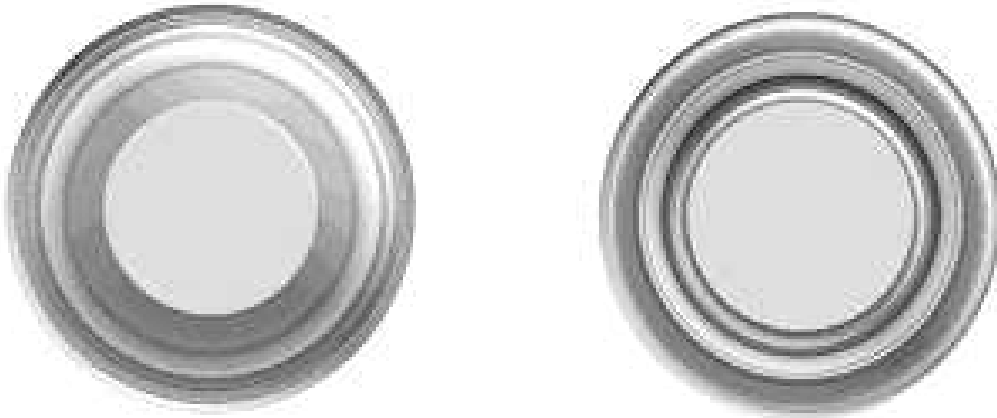

Løbenr. 2

(71) ANSØGER(E): Pi-Design AG, Kantonsstrasse 100, CH-6234 Triengen, Schweiz
(74) FULDMÆGTIG: Gorrissen Federspiel Kierkegaard, H.C. Andersens Boulevard 12, 1553 København V, Danmark
(22) ANSØGNINGSDATO: 2008-02-11
(18) GYLDIG TIL: 2013-02-11



Løbenr. 1

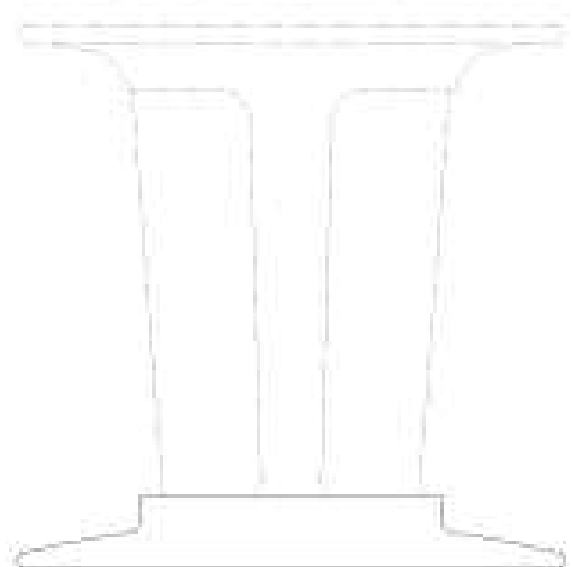
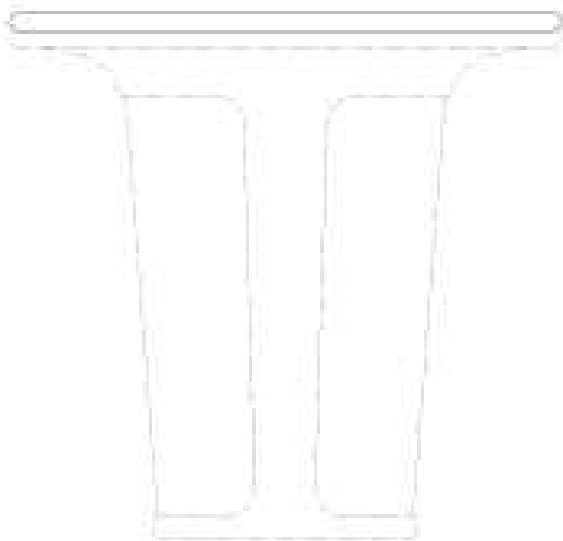

Løbenr. 2

(71) ANSØGER(E):
(74) FULDMÆGTIG:
(22) ANSØGNINGSDATO:
(18) GYLDIG TIL:

Pi-Design AG, Kantonsstrasse 100, CH-6234 Triengen, Schweiz
Gorrissen Federspiel Kierkegaard, H.C. Andersens Boulevard 12, 1553 København V, Danmark
2008-02-12
2013-02-12

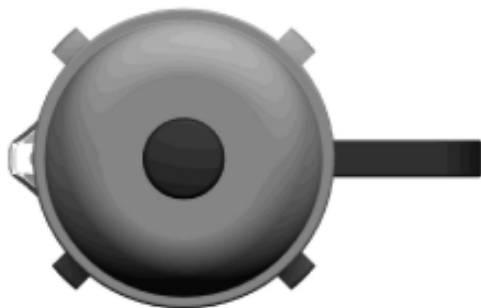
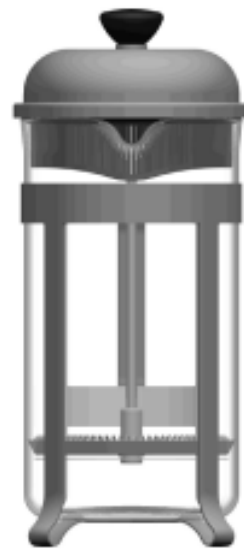
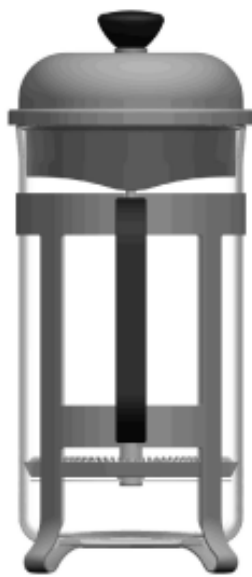

Løbenr. 1



Løbenr. 2

(71) ANSØGER(E):
(74) FULDMÆGTIG:
(22) ANSØGNINGSDATO:
(18) GYLDIG TIL:

Pi-Design AG, Kantonsstrasse 100, CH-6234 Triengen, Schweiz
Gorrissen Federspiel Kierkegaard, H.C. Andersens Boulevard 12, 1553 København V, Danmark
2008-02-15
2013-02-15

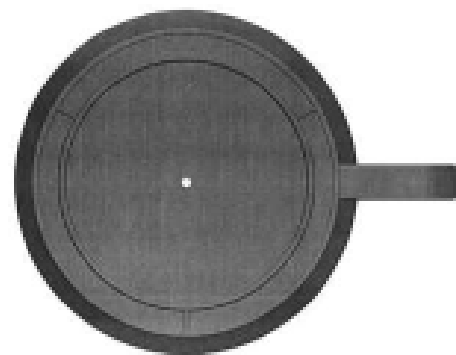
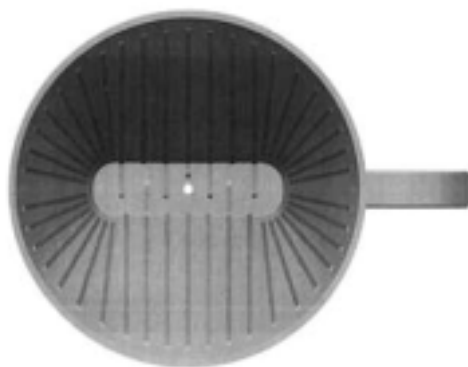
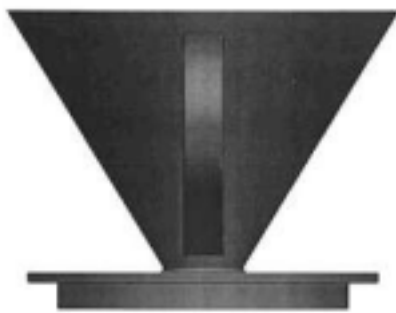

Løbenr. 1

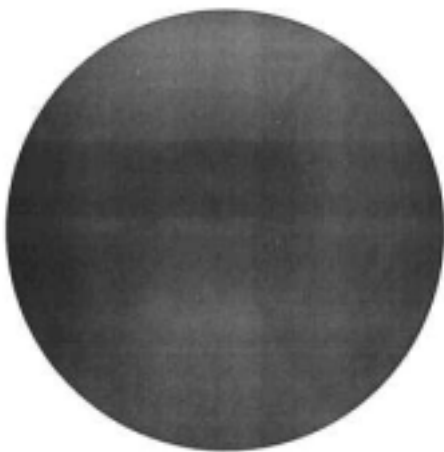

Løbenr. 2

(71) ANSØGER(E):
(74) FULDMÆGTIG:
(22) ANSØGNINGSDATO:
(18) GYLDIG TIL:

Pi-Design AG, Kantonsstrasse 100, CH-6234 Triengen, Schweiz
Gorrissen Federspiel Kierkegaard, H.C. Andersens Boulevard 12, 1553 København V, Danmark
2008-02-14
2013-02-14

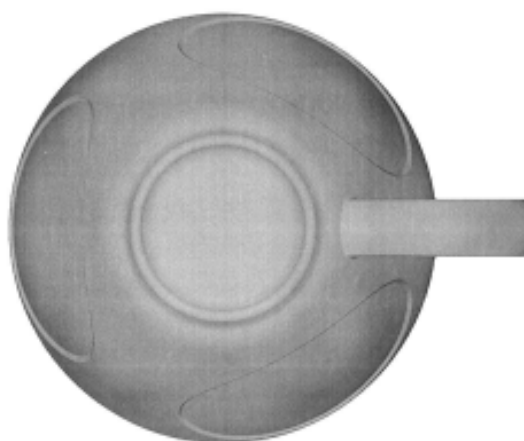
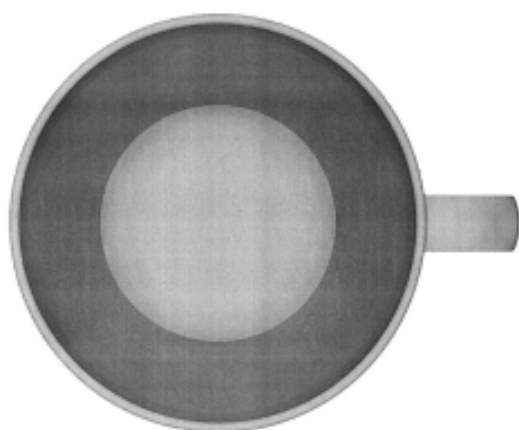
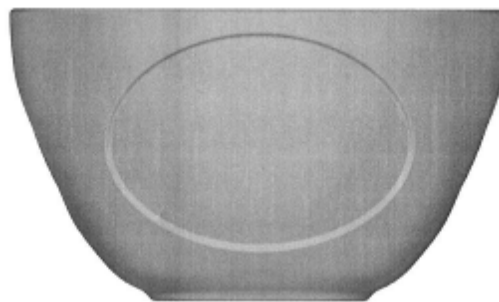
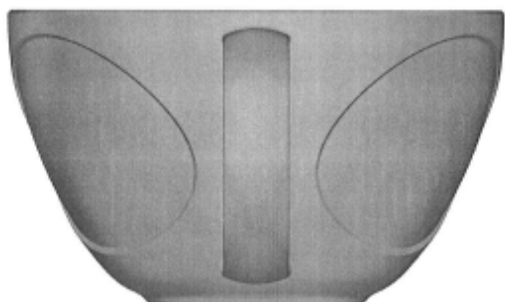
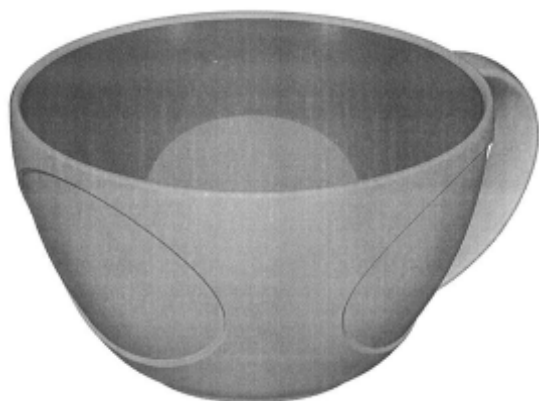

(71) ANSØGER(E):
(74) FULDMÆGTIG:
(22) ANSØGNINGSDATO:
(18) GYLDIG TIL:

Pi-Design AG, Kantonsstrasse 100, CH-6234 Triengen, Schweiz
Gorrissen Federspiel Kierkegaard, H.C. Andersens Boulevard 12, 1553 København V, Danmark
2008-02-19
2013-02-19

(21) DA 2008 00053

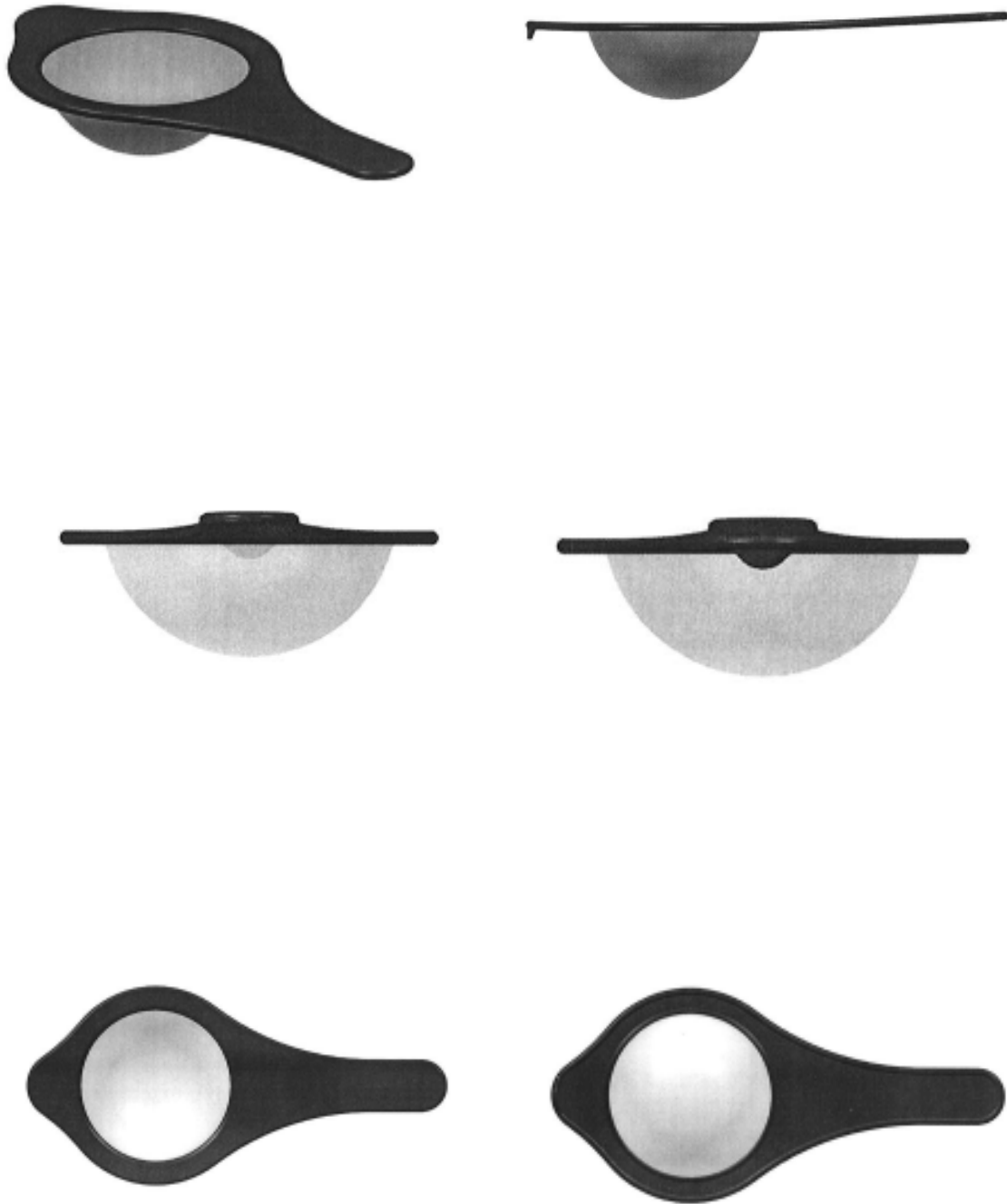

Løbenr. 1

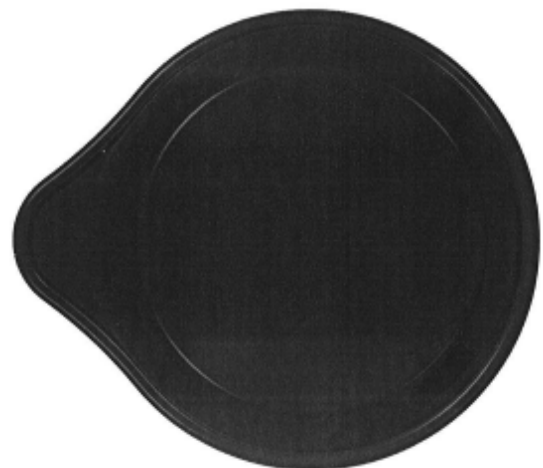
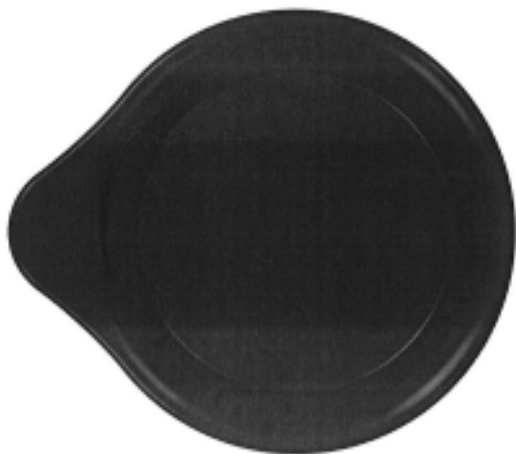
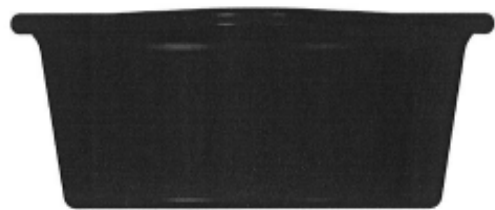
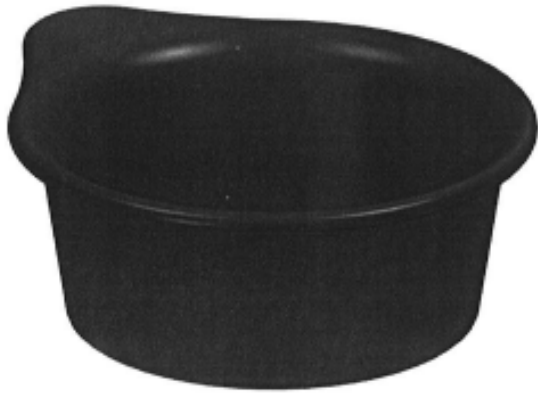

Løbenr. 2

(71) ANSØGER(E):
(74) FULDMÆGTIG:
(22) ANSØGNINGSDATO:
(18) GYLDIG TIL:

Pi-Design AG, Kantonsstrasse 100, CH-6234 Triengen, Schweiz
Gorrissen Federspiel Kierkegaard, H.C. Andersens Boulevard 12, 1553 København V, Danmark
2008-02-18
2013-02-18

(11) DR 2008 00143
 (21) DA 2008 00174

(54) 1-2 Skåle

(51)-Cl.07 01

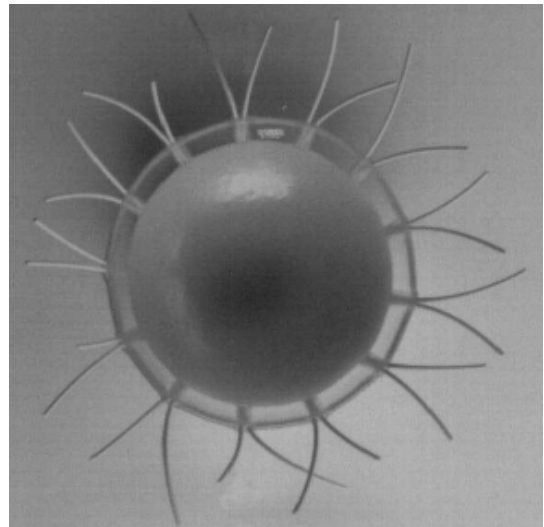

Løbenr. 1

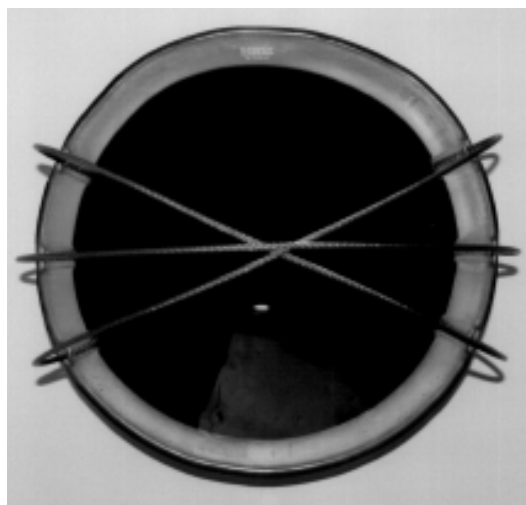
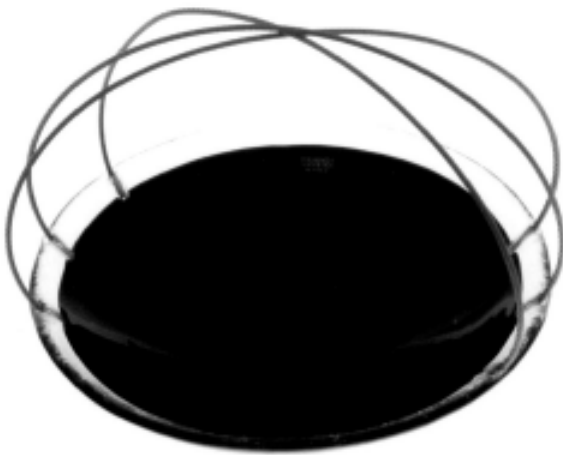

Løbenr. 2

(71) ANSØGER(E):
 (22) ANSØGNINGSDATO:
 (18) GYLDIG TIL:

Hjørhøy Glas-Design v/Frank Hjørhøy, Grejsdalsparken 12, 7100 Vejle, Danmark
 2008-08-11
 2013-08-11

(11) DR 2008 00144
 (21) DA 2008 00050

(54) 1) En pergola primus pavillon 2-3)dele dertil

(51)-Cl.25 03

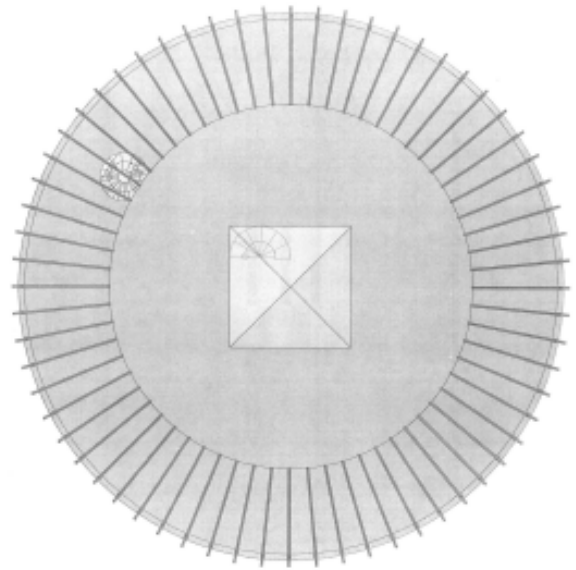
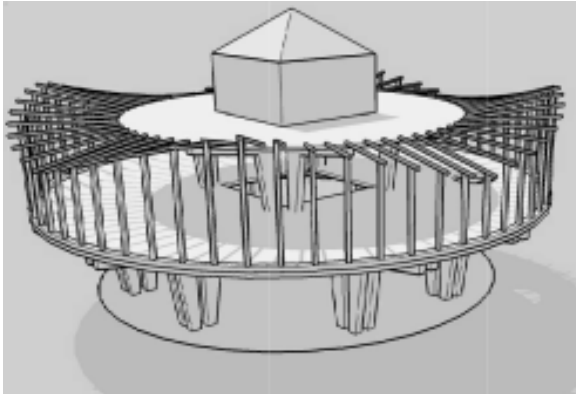

Løbenr. 1

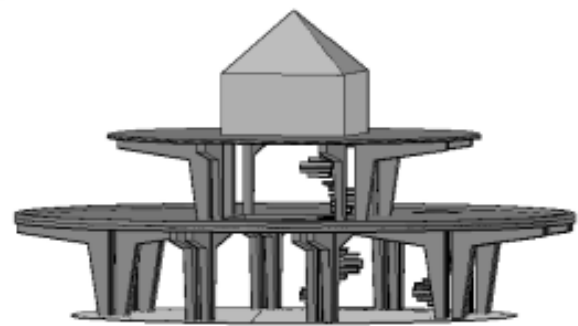
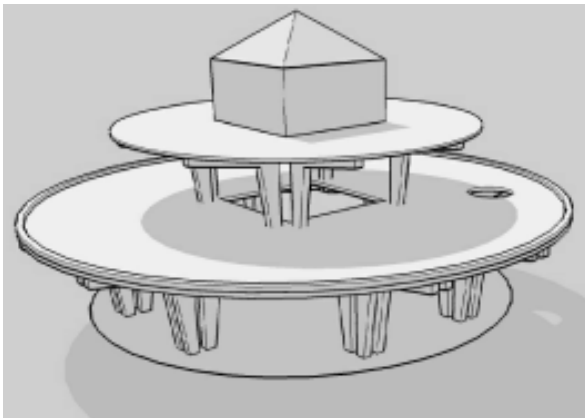

Løbenr. 2

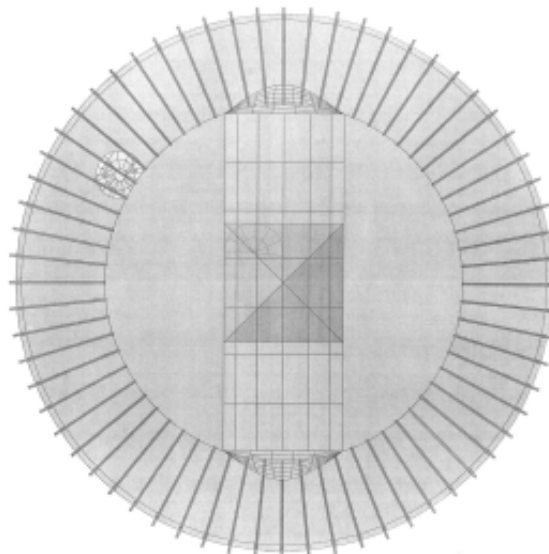

Løbenr. 3

(71) ANSØGER(E):
 (74) FULDMÆGTIG:
 (22) ANSØGNINGSDATO:
 (18) GYLDIG TIL:

Rolf Leonard Madsen, Ved Stadsgraven 9, kld.tv., 2300 København S, Danmark
 Avant-Byg á lá mo-Model Design v/Rolf Madsen, Ved Stadsgraven 9, kl.tv., 2300 København S, Danmark
 2008-02-18
 2013-02-18

(11) DR 2008 00145
(21) DA 2008 00170

(54) En glasskrivetavle med lcdmonitor

(51)-Cl.14 03;19 06



(71) ANSØGER(E):
(22) ANSØGNINGSDATO:
(18) GYLDIG TIL:

NORDISK SKOLETAVLEFABRIK A/S, Nordager 26, 6000 Kolding, Danmark
2008-07-15
2013-07-15

(11) DR 2008 00146
(21) DA 2008 00058

(54) 1) En chokoladekande 2) stempelkrus 3) stempelkande

(51)-Cl.07 01

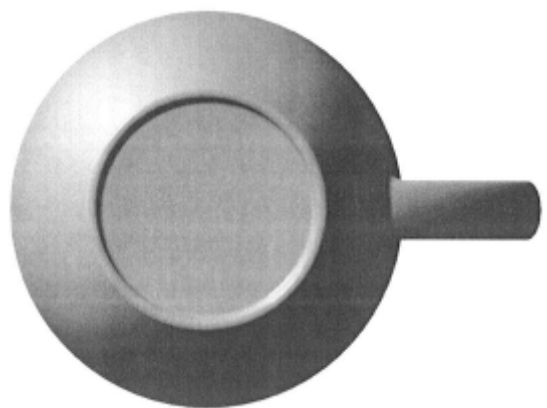
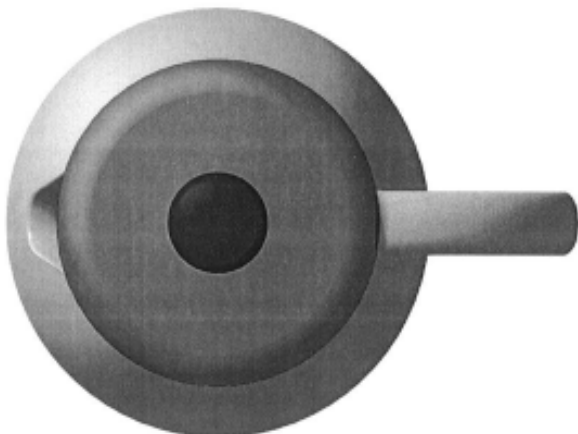
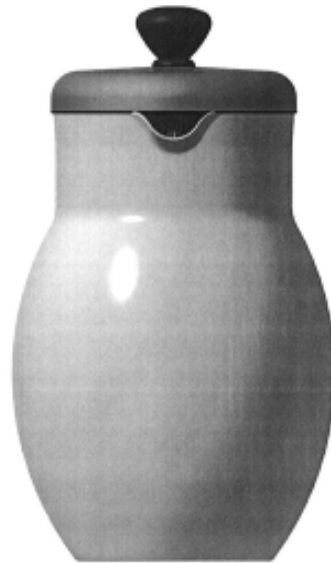
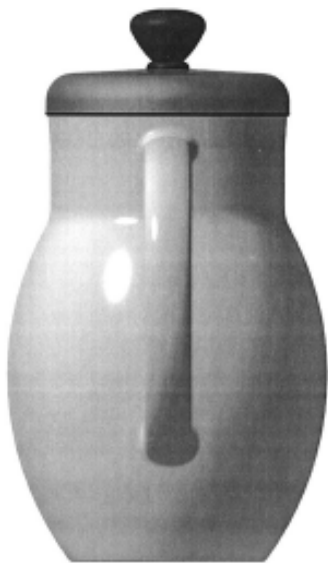

Løbenr. 1

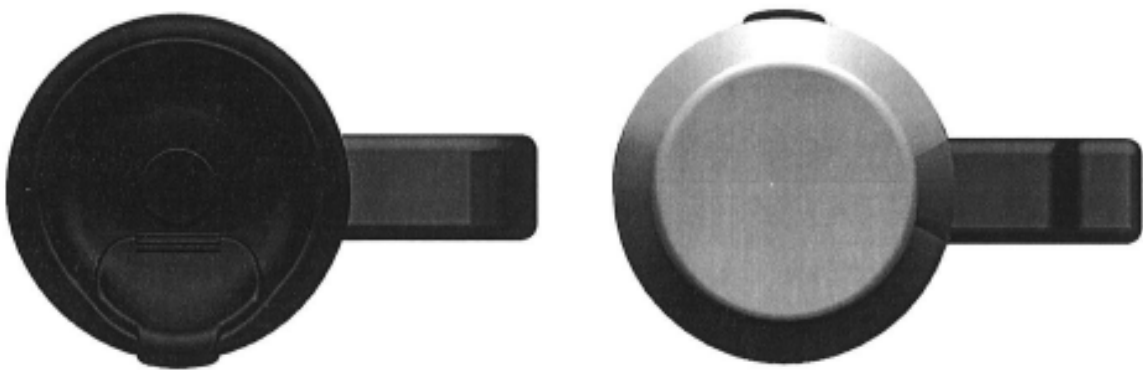
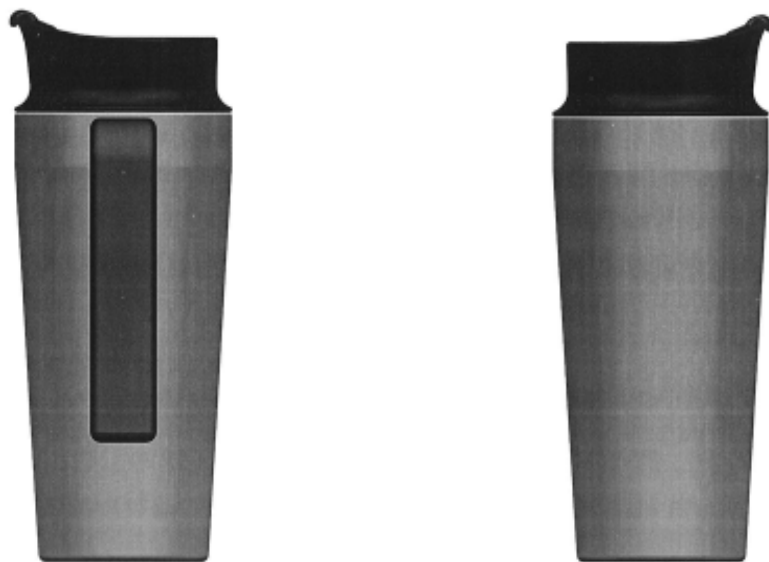

Løbenr. 2

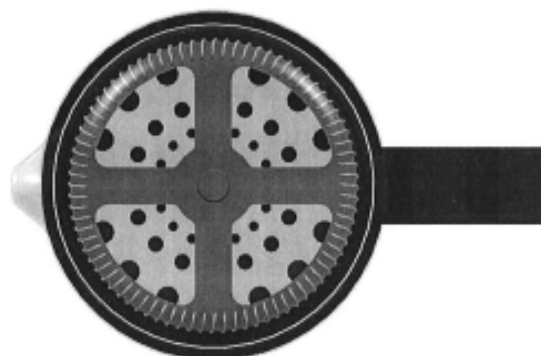
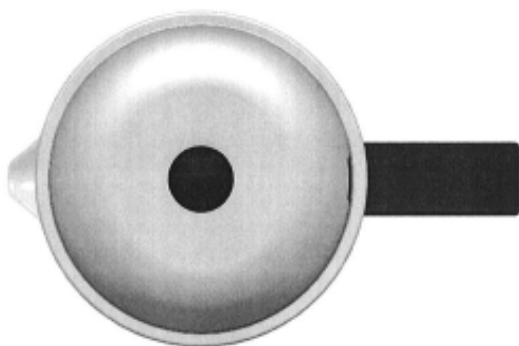
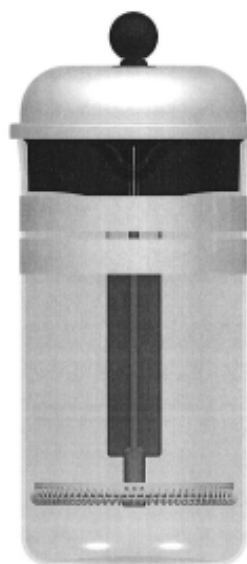
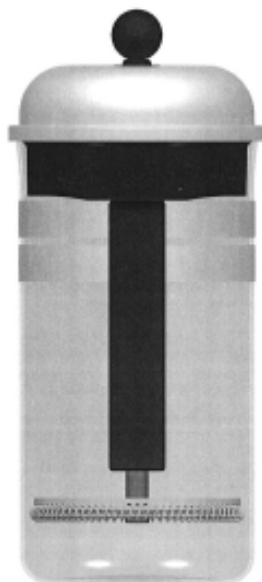

Løbenr. 3

(71) ANSØGER(E):
(74) FULDMÆGTIG:
(22) ANSØGNINGSDATO:
(18) GYLDIG TIL:

Pi-Design AG, Kantonsstrasse 100, CH-6234 Triengen, Schweiz
Gorrissen Federspiel Kierkegaard, H.C. Andersens Boulevard 12, 1553 København V, Danmark
2008-02-22
2013-02-22

Offentligt tilgængelige designansøgninger og -registreringer

Akterne i nedenstående ansøgninger eller registreringer er tilgængelige for enhver, jf. § 21, stk. 2, i designlov nr. 1259 af 20. december 2000.

Klasse 3

Varer til rejsebrug, etuier, parasoller og varer til personlig brug (ikke indeholdt i andre klasser)

(21) DA 2008 00036
(71) ANSØGER(E):
(22) ANSØGNINGSDATO:

(54) Et nøgleophæng
DOK 54 ApS, Uhrevej 3, 6064 Jordrup, Danmark
2008-02-07

Klasse 6

Møbler og andre boligudstørsartikler

(21) DA 2008 00036
(71) ANSØGER(E):
(22) ANSØGNINGSDATO:

(54) Et nøgleophæng
DOK 54 ApS, Uhrevej 3, 6064 Jordrup, Danmark
2008-02-07

Klasse 7

Husholdningsartikler (ikke indeholdt i andre klasser)

(21) DA 2008 00039
(71) ANSØGER(E):
(22) ANSØGNINGSDATO:

(54) 3) sukkerskål;1-2) Flødekander
Pi-Design AG, Kantonsstrasse 100, CH-6234 Triengen, Schweiz
2008-02-07

(21) DA 2008 00042
(71) ANSØGER(E):
(22) ANSØGNINGSDATO:

(54) 1-2) Glas
Pi-Design AG, Kantonsstrasse 100, CH-6234 Triengen, Schweiz
2008-02-11

(21) DA 2008 00043
(71) ANSØGER(E):
(22) ANSØGNINGSDATO:

(54) 1) Et filter, 2) kombineret låg og holder til filter
Pi-Design AG, Kantonsstrasse 100, CH-6234 Triengen, Schweiz
2008-02-12

(21) DA 2008 00046
(71) ANSØGER(E):
(22) ANSØGNINGSDATO:

(54) 1) En filterholder 2) Låg
Pi-Design AG, Kantonsstrasse 100, CH-6234 Triengen, Schweiz
2008-02-14

(21) DA 2008 00048
(71) ANSØGER(E):
(22) ANSØGNINGSDATO:

(54) 2) rejsekrus;1) En stempelkande 2) rejsekrus
Pi-Design AG, Kantonsstrasse 100, CH-6234 Triengen, Schweiz
2008-02-15

(21) DA 2008 00052
(71) ANSØGER(E):
(22) ANSØGNINGSDATO:

(54) Et krus
Pi-Design AG, Kantonsstrasse 100, CH-6234 Triengen, Schweiz
2008-02-19

(21) DA 2008 00053
(71) ANSØGER(E):
(22) ANSØGNINGSDATO:

(54) 1) En tesi 2) del dertil
Pi-Design AG, Kantonsstrasse 100, CH-6234 Triengen, Schweiz
2008-02-18

(21) DA 2008 00058
(71) ANSØGER(E):
(22) ANSØGNINGSDATO:

(54) 1) En chokoladekande 2) stempelkrus 3) stempelkande
Pi-Design AG, Kantonsstrasse 100, CH-6234 Triengen, Schweiz
2008-02-22

Klasse 25

Bygninger og byggelementer

(21) DA 2008 00050
(71) ANSØGER(E):
(22) ANSØGNINGSDATO:

(54) 1) En pergola primus pavillon 2-3)dele dertil
Rolf Leonard Madsen, Ved Stadsgraven 9, kld.tv., 2300 København S, Danmark
2008-02-18

Klasse 26

Belysningsapparatur

(21) DA 2008 00038
(71) ANSØGER(E):
(22) ANSØGNINGSDATO:

(54) 1-2) Lysestager
Pi-Design AG, Kantonsstrasse 100, CH-6234 Triengen, Schweiz
2008-02-05

Fornyelse af designregistreringer

Fornyelse af registreringer foretaget i medfør af § 23, stk. 1, i designlov nr. 1259 af 20. december 2000.

(11) Registreringsnummer	(18) Gyldig til
DR 2004 00014	20130714
DR 2003 00485	20130915
DR 2003 00496	20130916
DR 2003 00543	20130815
DR 2003 00461	20130820
DR 2003 00464	20130821

Udslettede registreringer

Udslettede registreringer foretaget i medfør af designlov nr. 1259 af 20. december 2000.

(11) DR 2003 00039
(11) DR 2003 00232
(11) DR 2003 00021
(11) DR 2003 00240
(11) DR 2003 00046
(11) DR 2003 00058
(11) DR 2003 00050
(11) DR 2003 00057
(11) DR 2003 00342
(11) DR 2003 00376
(11) DR 2003 00154
(11) DR 2003 00146
(11) DR 2003 00147
(11) DR 2003 00148
(11) DR 2003 00149
(11) DR 2003 00278
(11) DR 2003 00377
(11) DR 2003 00065
(11) DR 2003 00193
(11) DR 2003 00194
(11) DR 2003 00195
(11) DR 2003 00196
(11) DR 2003 00197
(11) DR 2003 00198
(11) DR 2003 00199
(11) DR 2003 00200
(11) DR 2003 00466
(11) DR 2003 00412
(11) DR 2003 00430

Mønster

Ændringer

Ændringer vedrørende retten til mønstret, mønsterhavers navn, bopæl, fulm. m.v.

Navneændringer:

(11) MR 1998 00462

Til: (71) Continental Automotive Switzerland AG, Industrieplatz 3, 8212 Neuhausen, Schweiz

Fornyelse af mønsterregistreringer

Fornyelse af registreringer foretaget i medfør af lov om mønstre nr. 218 af 27. maj 1970.

(11) Registreringsnummer	(18) Gyldig til
MR 1999 00324	20130827
MR 1999 00454	20131103
MR 1999 00825	20130817
MR 1999 00353	20130911
MR 1999 00411	20130930
MR 1999 00412	20130930
MR 1999 00413	20130930
MR 1999 00552	20130907
MR 1999 00347	20130910
MR 1999 00348	20130910
MR 1999 00489	20130910
MR 1999 00354	20130915
MR 2000 00612	20130921
MR 1999 00337	20130907
MR 1999 00346	20130813
MR 1999 00328	20130901
MR 1999 00187	20130715
MR 1999 00558	20131020
MR 1999 00332	20130904
MR 1999 00409	20130928
MR 1999 00456	20131103
MR 1999 00455	20131103

Udslettelser af registreringer

Udslettelser af registreringer foretaget i medfør af lov om mønstre nr. 218 af 27. maj 1970.

(11) MR 1994 00400
(11) MR 1994 00402
(11) MR 1994 00675
(11) MR 1994 00302
(11) MR 1994 00303
(11) MR 1994 00743
(11) MR 1994 00327
(11) MR 1994 00375
(11) MR 1994 00379
(11) MR 1994 00270
(11) MR 1994 00305
(11) MR 1998 00627
(11) MR 1998 00628
(11) MR 1998 00629
(11) MR 1998 00630
(11) MR 1998 00676
(11) MR 1998 00853
(11) MR 1998 00633
(11) MR 1998 00679
(11) MR 1998 00680
(11) MR 1998 00681
(11) MR 1998 00878
(11) MR 1998 00682
(11) MR 1998 00909
(11) MR 1998 00698
(11) MR 1998 00783
(11) MR 1998 00784
(11) MR 1998 00785
(11) MR 1998 00786
(11) MR 1998 00787
(11) MR 1998 00788
(11) MR 1998 00789
(11) MR 1998 00790
(11) MR 1998 00791
(11) MR 1998 00792
(11) MR 1999 00544

Rettelse

DA 2008 00050 er ved en fejl blevet publiceret i Dansk Designtidende nr. 16 den 15. august 2008, med Registrerings nr. DR 2008 00130, dette registrerings nr. er blevet annulleret. Sagen har fået registrerings nr. DR 2008 00144. Sagen er publiceret som to produkter i ovennævnte tidende. Der er tale om i alt 3 produkter.

WIPO Standard 80

INID-koder

Internationally agreed Numbers for the Identification of (bibliographic) data (INID)

- (11) Serial number of the registration
- (15) Date of the registration/Date of the renewal
- (17) Expected duration of the registration/
renewal
- (18) Expected expiration date of the registration/
renewal
- (21) Serial number of the application
- (22) Date of filing of the application
- (23) Name and place of exhibition, and date on
which the industrial design was first
exhibited there (Exhibition priority date)
- (24) Date from which the industrial design right
has effect
- (29) Indication of the form in which the industrial
design is filed, e.g. as a reproduction of the
industrial design or as a specimen thereof
- (30) Data relating to priority under the Paris
Convention
- (43) Date of publication of the industrial design
before examination
- (44) Date of publication of the industrial design
after examination but before registration
- (45) Date of publication of the registered
industrial design
- (46) Date of expiration of deferment
- (51) International Classification for Industrial
Designs (class and subclass of the Locarno
Classification)
- (54) Designation of article(s) or product(s)
covered by the industrial design or title of
the industrial design
- (55) Reproduction of the industrial design (e.g.,
drawing, photograph) and explanations
relating to the reproduction
- (57) Description of characteristic features of the
industrial design including indication of
colors
- (58) Date of recording of any kind of
amendment in the Register
- (62) Serial number(s) and, if available, filing
date(s) of application(s), registration(s) or
document(s) related by division
- (66) Serial number(s) of the application or the
registration of the design(s), which is(are) a
variant(s) of the present one
- (71) Name(s) and address(es) of the appli-
cant(s)
- (72) Name(s) of the creator(s) if known to be
such
- (73) Name(s) and address(es) of the owner(s)
- (74) Name(s) and address(es) of the
representative(s)

Domestic Codes for the Identification of Data

- (DL) Data concerning license
- (DP) Data concerning pawning

Internationalt vedtagne Numre til Identifikation af Data (INID)

Registreringsnummer
Registreringsdato/fornyelsesdato
Forventet registreringsperiode/fornyelsesperiode
Forventet udløbsdato for registrering/fornyelse

Ansøgningsnummer
Ansøgningsdato
Udstillingsnavn og -sted og dato for første udstil-
ling (udstillingsprioritetsoplysninger)

Indleveringsdato

Angivelse af i hvilken form designet er indleveret,
fx som en afbildning af designet eller som en
model heraf
Oplysninger om prioritet efter Pariserkonventionen

Dato for offentlig tilgængelighed

Bekendtgørelsesdato for ansøgningen

Offentliggørelse af registreringen

Udsættelsesdato
International klassifikation af design (klasser og
underklasser i Locarno Klassifikationen)

Vareangivelse/produktangivelse

Afbildninger af designet (fx tegninger, fotografier)
og forklaringer vedrørende afbildningerne

Beskrivelse af karakteristiske træk vedr. designet,
herunder angivelse af farver
Dato for tilførsel til registret

Nummer på hovedansøgning eller udskilt ansøg-
ning

Numre på beslægtede ansøgninger

Ansøgningsnavn og -adresse
Frembringers/designers navn og adresse
Indehavernavn og -adresse
Fuldmægtignavn og -adresse

Interne koder til identifikation af data

Licensoplysninger
Pantoplysninger
Oplysninger om konkurs