



PATENT- OG VAREMÆRKESTYRELSEN

Dansk Design- tidende

Indholdsfortegnelse

Designsager

Offentliggørelse af designregistreringer	112
Offentligt tilgængelige designansøgninger	132
Ændringer til design	133
Fornyelse af designregistreringer	134
Udslettelse af designregistreringer	135

Mønstersager

Ændringer til mønstre	137
Fornyelse af mønsterregistreringer	138

Dansk Designtidende kan rekvireres som papirkopi for kr. 150 stk. på tlf. 43 50 85 35

Ansvarlig for redaktion: Keld Nymann Jensen
Udgives af Patent- og Varemærkestyrelsen, Helgeshøj Allé 81, 2630 Tåstrup, tlf. 43 50 80 00

ISSN 1601-7374

Design

Offentliggørelse af designregistreringer

Enhver kan anmode om hel- eller delvis udslettelse af en registrering (administrativ prøvning), jf. § 25 i designlov nr. 1259 af 20. december 2000.
En model af designet kan ses i Patent- og Varemærkestyrelsen, hvis det er offentliggjort, at en model er indleveret til styrelsen.
Det er anført, hvis et design er registreret i farve.

(11) DR 2008 00037
(21) DA 2007 00268

(54) 1-2) Transportemballage med bærehank til orkidéer (51)-Cl.09 03

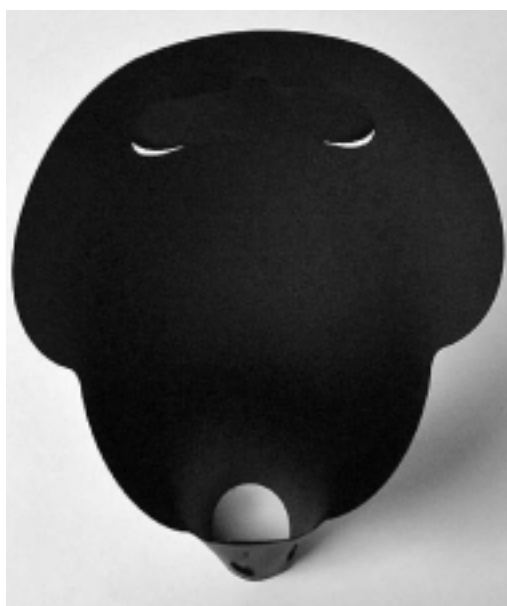

Løbenr. 1

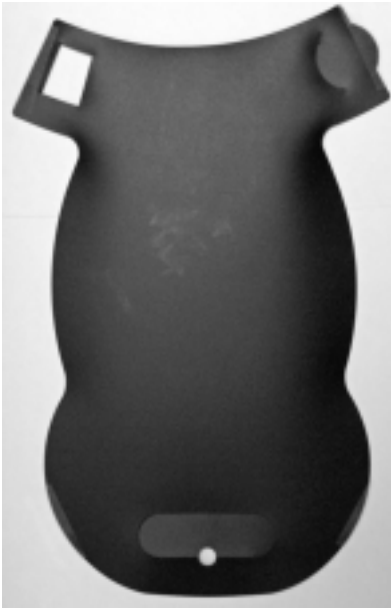

Løbenr. 1



Løbenr. 2

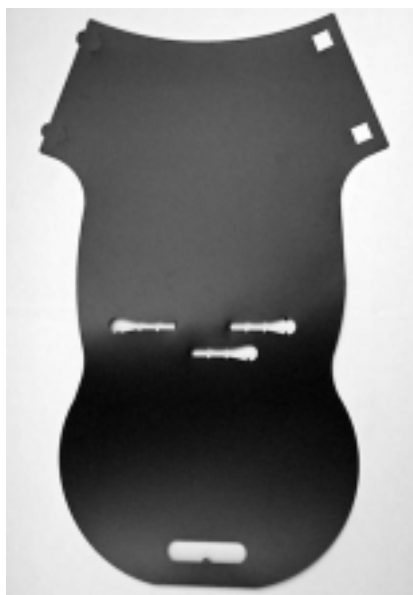
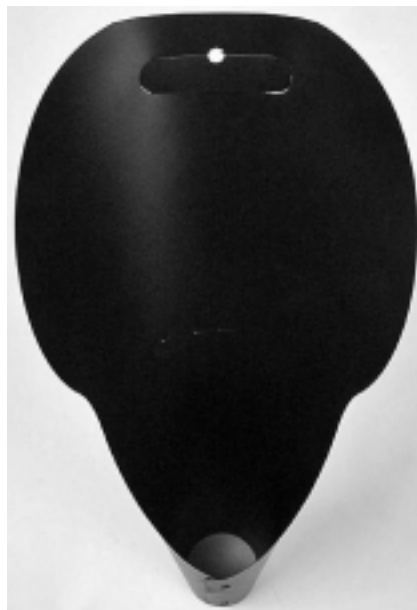

Løbenr. 2

(71) ANSØGER(E):
(72) FREMBRINGER(E):
(22) ANSØGNINGSDATO:
(18) GYLDIG TIL:

GARTNERIET GAMMELGÅRD ApS, Anderupvej 78, 5270 Odense N, Danmark
GARTNERIET GAMMELGÅRD ApS, Anderupvej 78, 5270 Odense N, Danmark
2007-11-14
2012-11-14

(11) DR 2008 00038
(21) DA 2008 00024

(54) Ornament

(51)-Cl.99 00

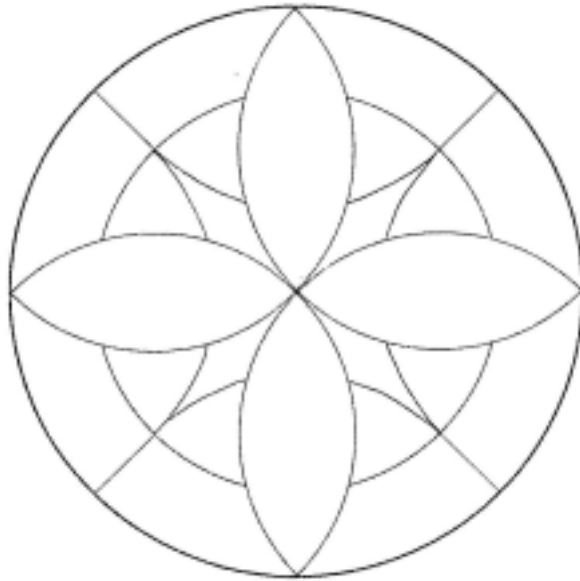

(71) ANSØGER(E):
(72) FREMBRINGER(E):
(22) ANSØGNINGSDATO:
(18) GYLDIG TIL:

Bent Wagner, Snærildvej 57, 8300 Odder, Danmark
Bent Wagner, Snærildvej 57, 8300 Odder, Danmark
2008-01-30
2013-01-30

(11) DR 2008 00039
(21) DA 2007 00209

(54) En lineær aktuator

(51)-Cl.15 99



(71) ANSØGER(E):
(74) FULDMÆGTIG:
(72) FREMBRINGER(E):
(22) ANSØGNINGSDATO:
(18) GYLDIG TIL:

Linak A/S, Smedevænget 8, Guderup, 6430 Nordborg, Danmark
Linak A/S, Patentafdelingen, Vesterbro 18, 9100 Aalborg, Danmark
John Landerholm, c/o Landerholm & Lund, Industriel Design ApS, Mejlgade 46 B, 8000 Århus C, Danmark
2007-09-01
2012-09-01

(11) DR 2008 00040
(21) DA 2008 00054

(54) Et greb til redskabsskaft

(51)-Cl.04 01

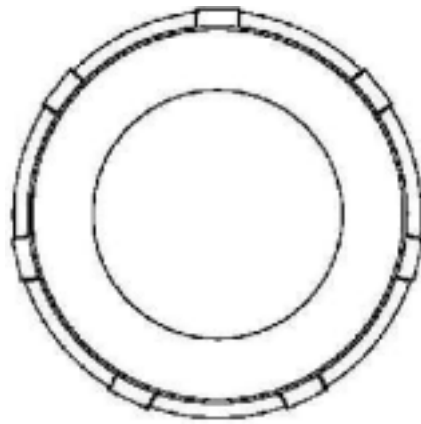
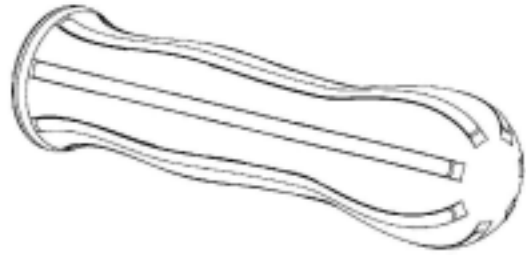

(71) ANSØGER(E):
(22) ANSØGNINGSDATO:
(18) GYLDIG TIL:

Locon ApS, Birkedam 10A /26, 6000 Kolding, Danmark
2008-02-20
2013-02-20

(11) DR 2008 00041
(21) DA 2008 00002

(54) En æskeemballage

(51)-Cl.09 03

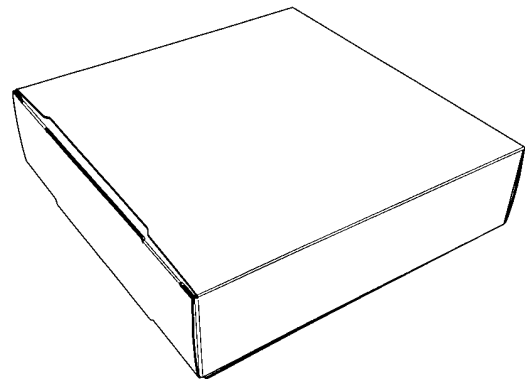
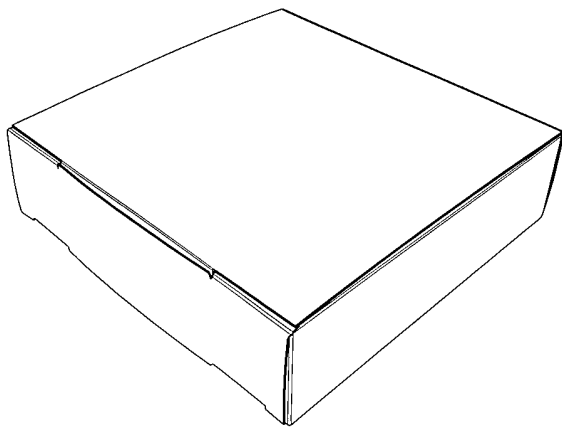
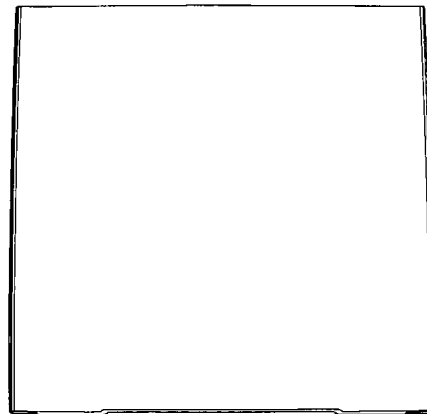
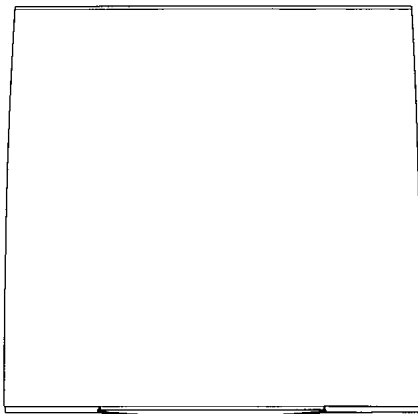
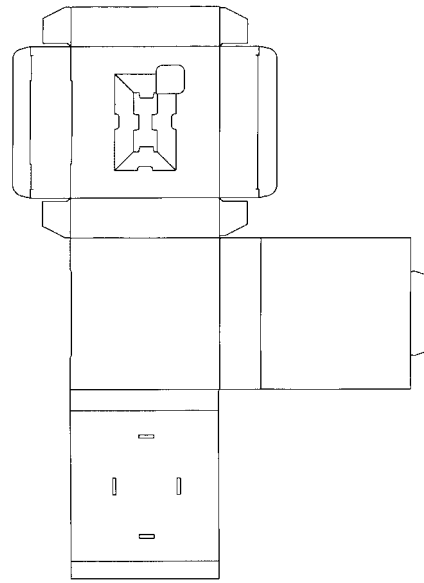
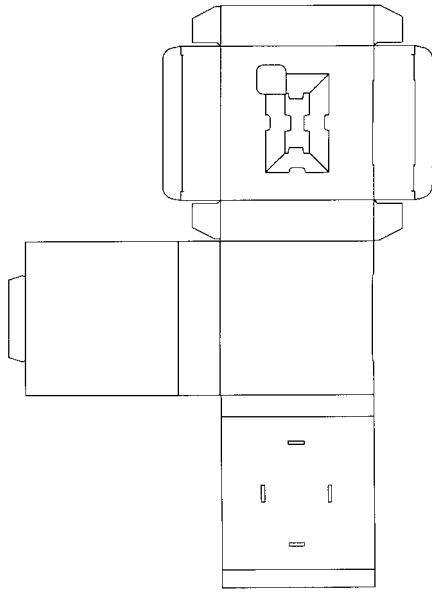

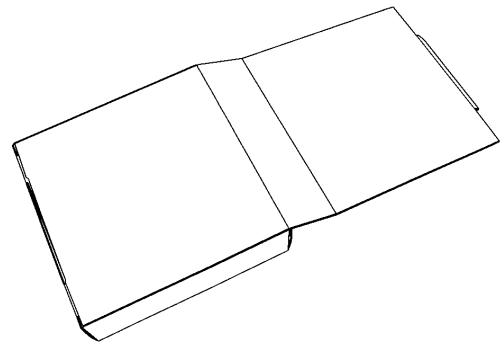
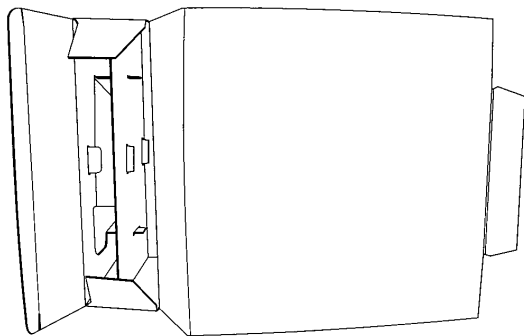
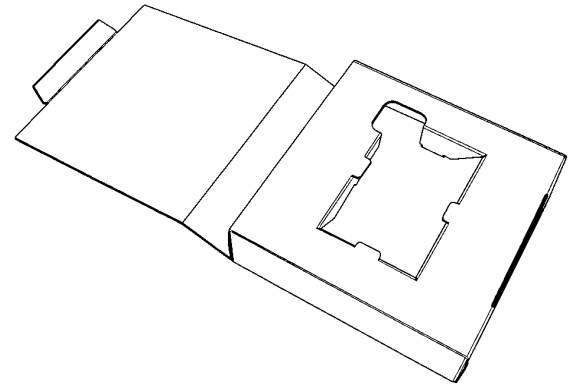
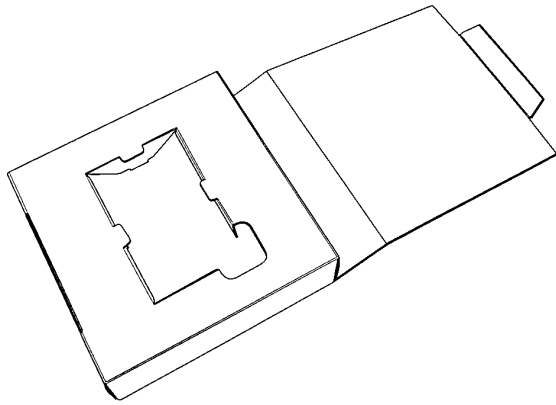
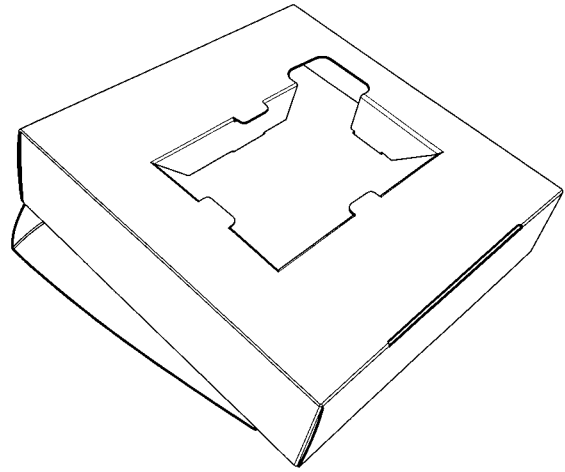
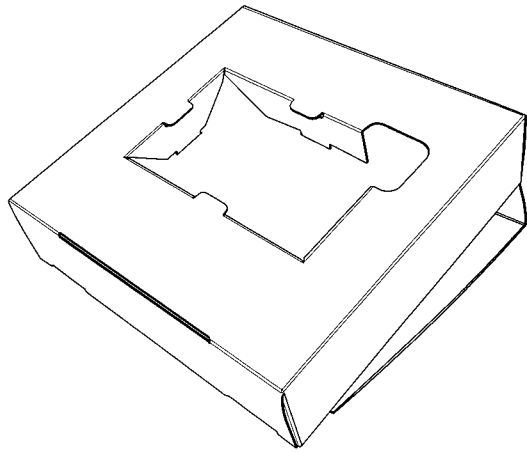

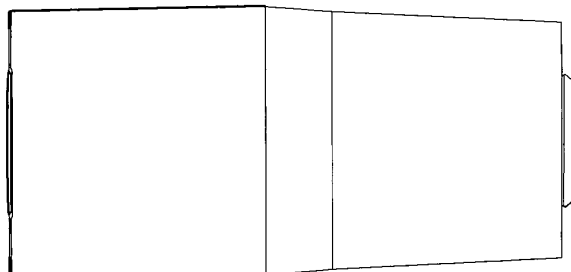
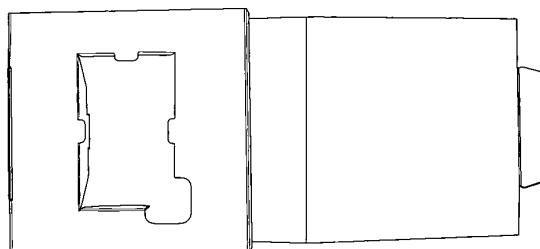

(71) ANSØGER(E): Nokia Corporation, Keilalahdentie 4, FI-02150 Espoo, Finland
(74) FULDMÆGTIG: Sandel, Løje & Wallberg, Frederiksgade 7, 1265 København K, Danmark
(72) FREMBRINGER(E): Hanna Lukka, c/o Nokia Corporation, Keilalahdentie 4, Espoo, FIN-02150, Finland
(30) PRIORITET: 2007-07-06 FI M20070135
(22) ANSØGNINGSDATO: 2008-01-07
(18) GYLDIG TIL: 2013-01-07

(11) DR 2008 00042
(21) DA 2008 00010

(54) 1) Et håndsæt 2) håndsæts tastaturknapper

(51)-Cl.14 03

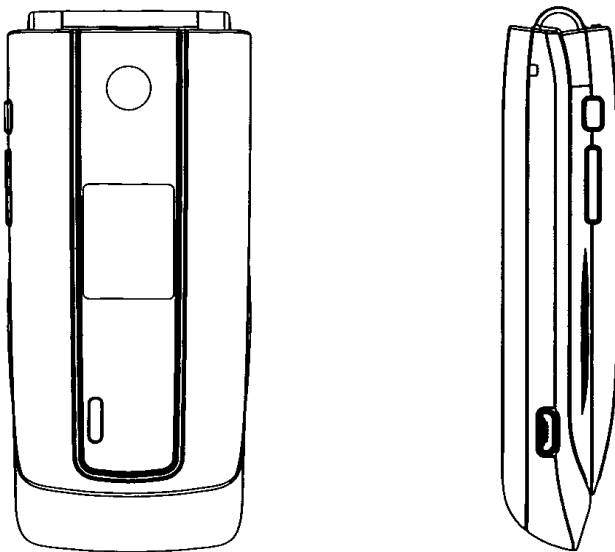
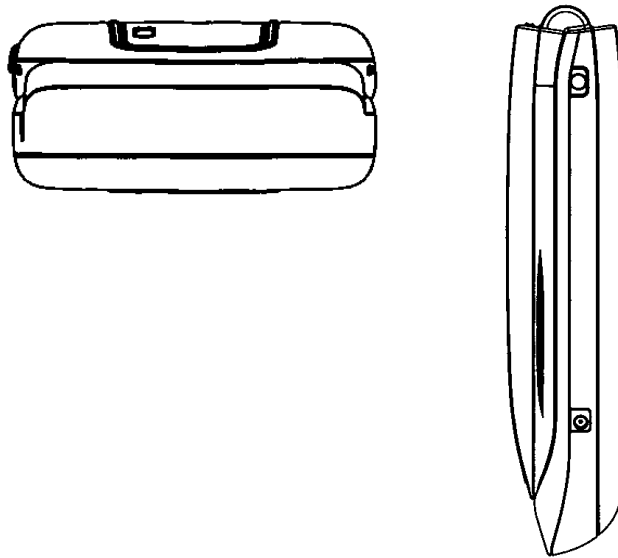

Løbenr. 1

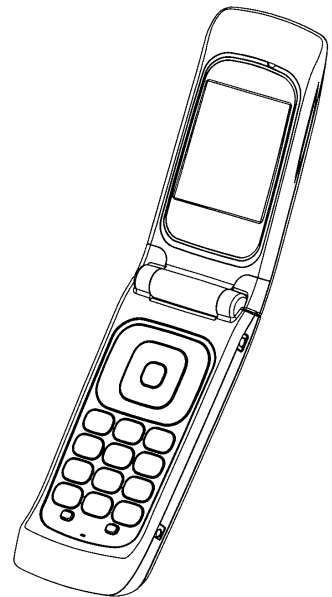
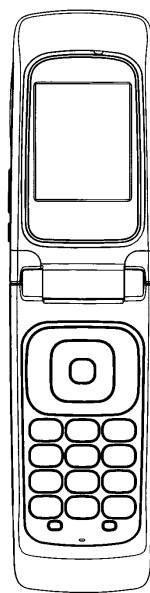
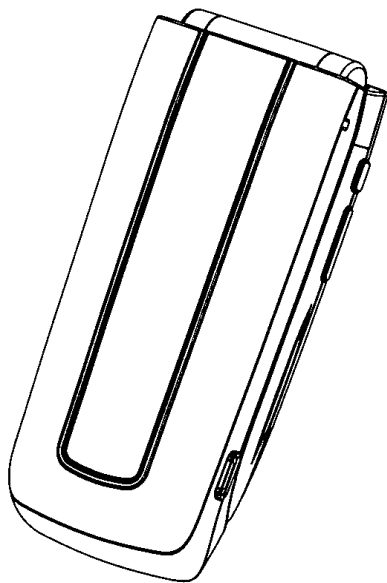
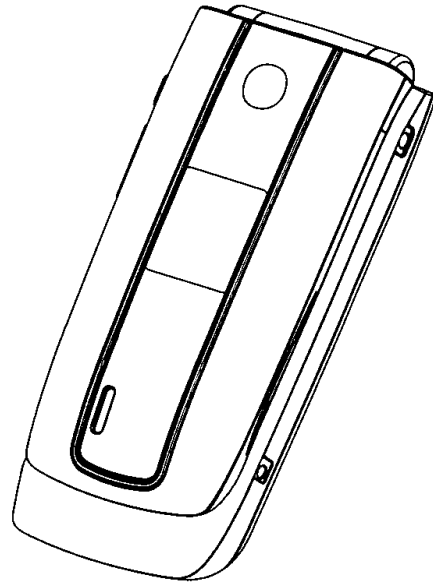
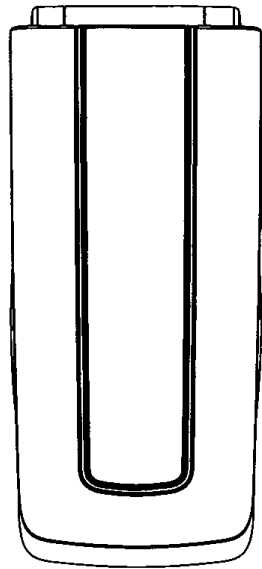

Løbenr. 1

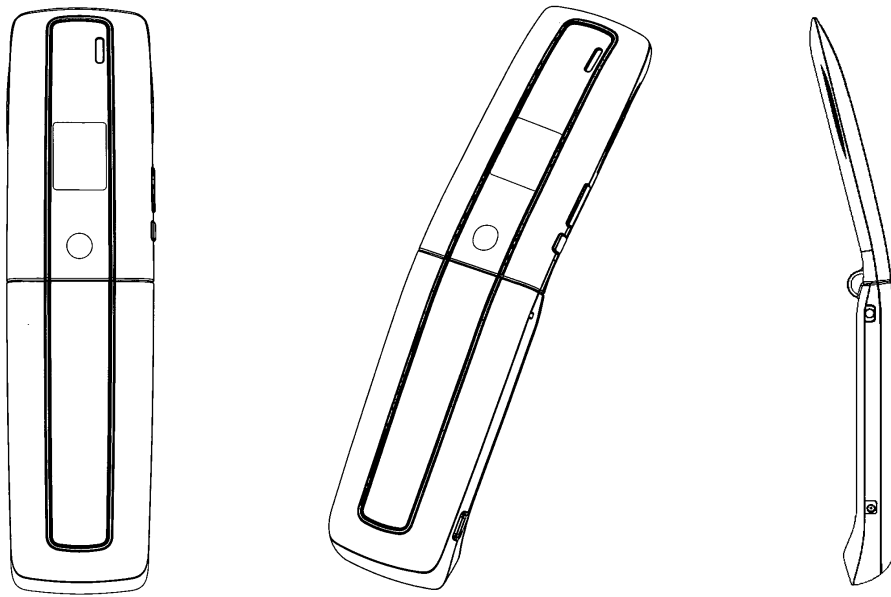

Løbenr. 1

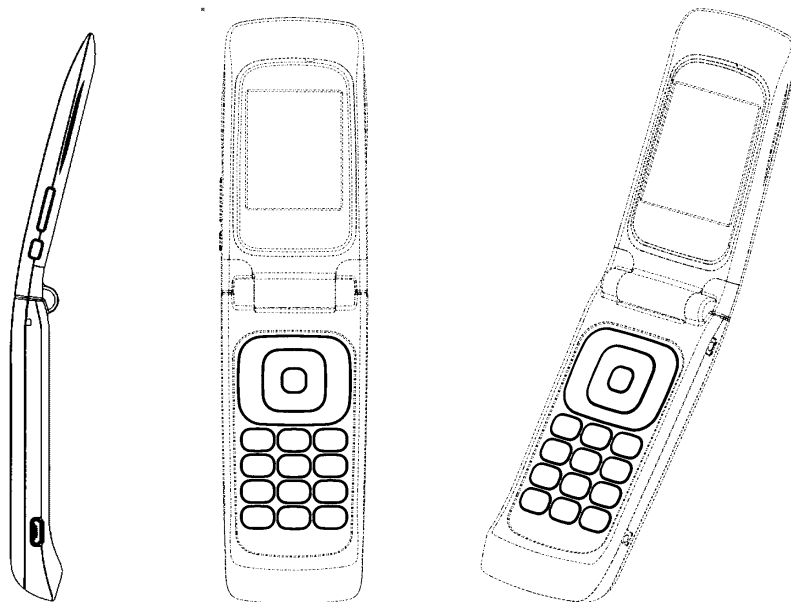

Løbenr. 1

Løbenr. 2

(71) ANSØGER(E):
 (74) FULDMÆGTIG:
 (72) FREMBRINGER(E):
 (30) PRIORITET:
 (22) ANSØGNINGSDATO:
 (18) GYLDIG TIL:

Nokia Corporation, Keilalahdentie 4, FI-02150 Espoo, Finland
 Sandel, Løje & Wallberg, Frederiksgade 7, 1265 København K, Danmark
 Justin Lyles, 12278 Scripps Summit Drive, San diego, CA 92131, USA
 2007-07-12 US 29/282,162
 2008-01-10
 2013-01-10

(11) DR 2008 00043
(21) DA 2008 00049

(54) En støbejerns fordampkedel

(51)-Cl.07 02





(71) ANSØGER(E): Renomme v/Allan Hansen, Skovstedvej 8, 8680 Ry, Danmark
(72) FREMBRINGER(E): 3PART A/S, Katrinebjergvej 115, 8200 Århus N, Danmark
(22) ANSØGNINGSDATO: 2008-02-16
(18) GYLDIG TIL: 2013-02-16

(11) DR 2008 00044

(54) 1) Et håndsæt 2) håndsæts tastaturknapper 3) håndsæt
4) håndsæts tastaturknapper 5) håndsæts frontdel
6) håndsæts tastaturknapper 7) håndsæts frontdel og tastaturknapper
(51)-Cl.14 03

(21) DA 2007 00306

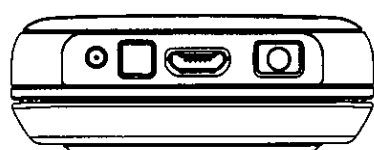
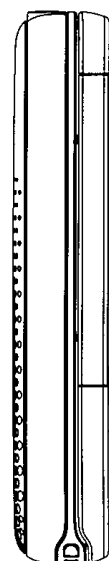
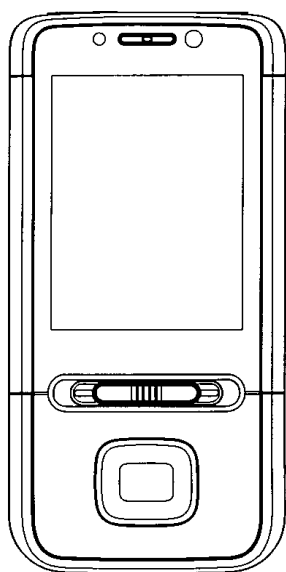
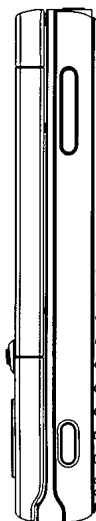

Løbenr. 1

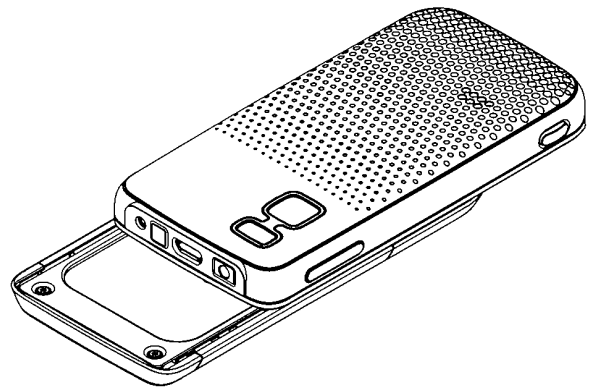
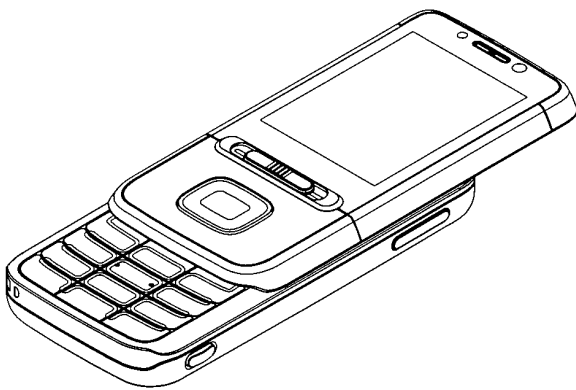
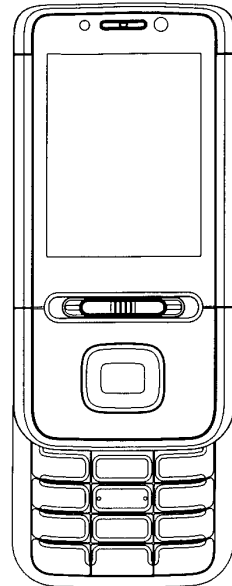
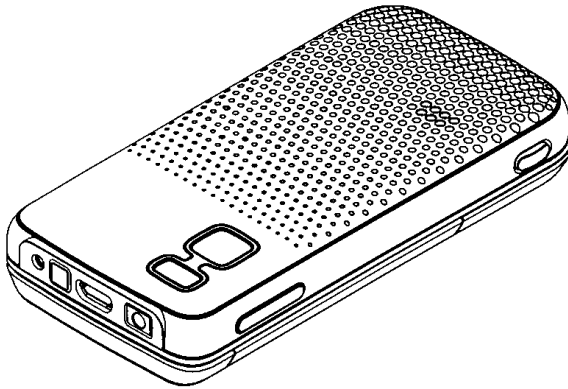
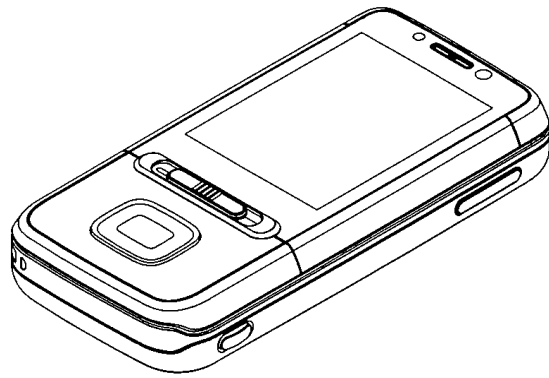
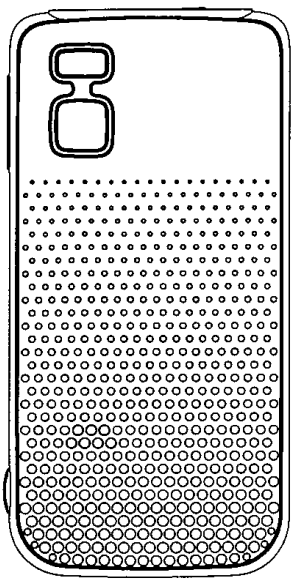

Løbenr. 1

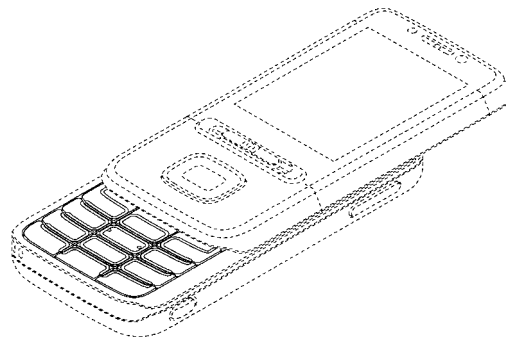
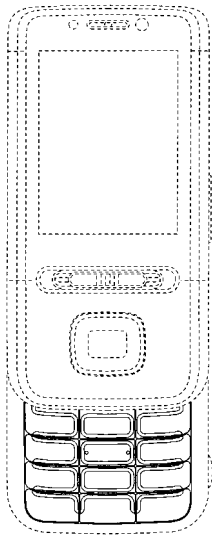

Løbenr. 2

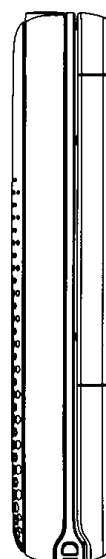
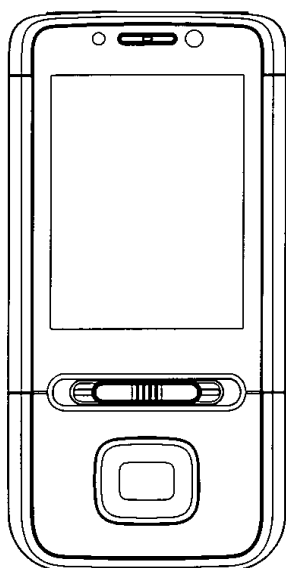
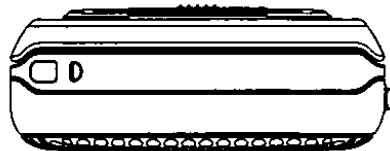

Løbenr. 3

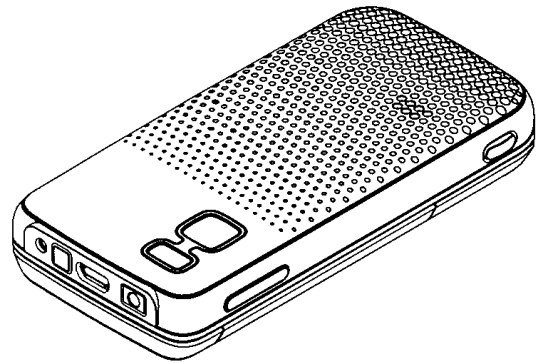
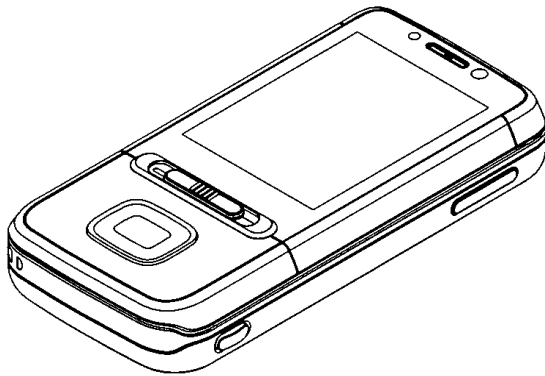
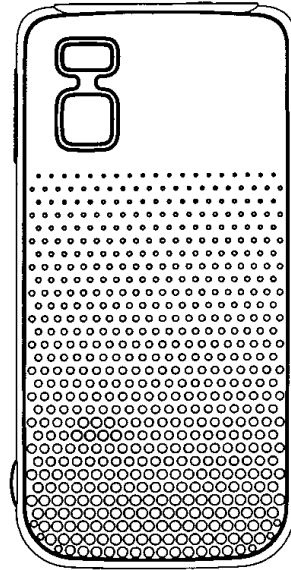

Løbenr. 3

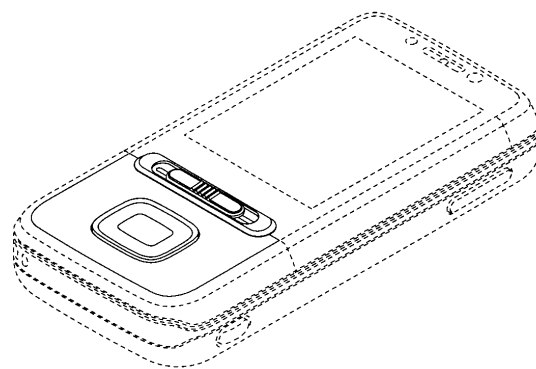
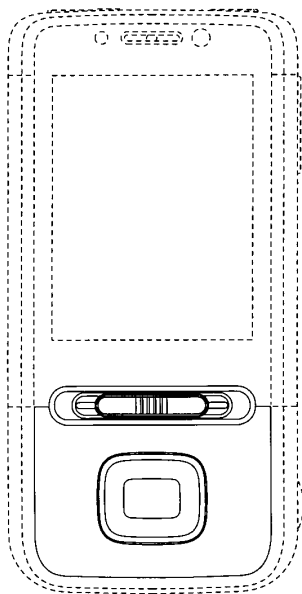

Løbenr. 4

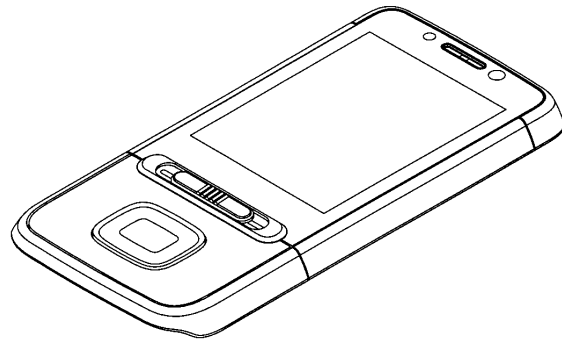
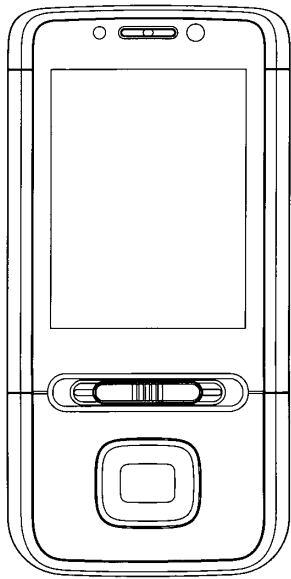

Løbenr. 5

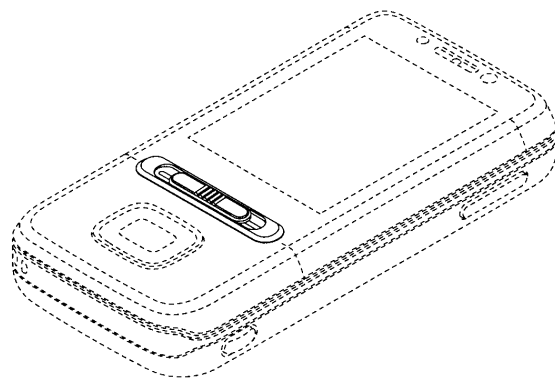
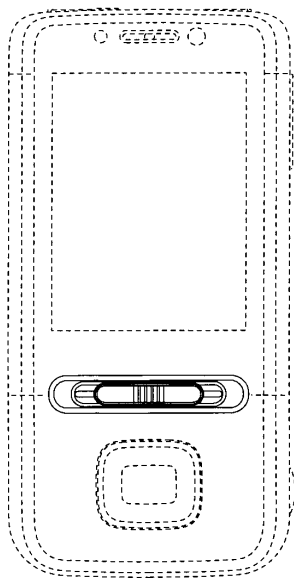

Løbenr. 6

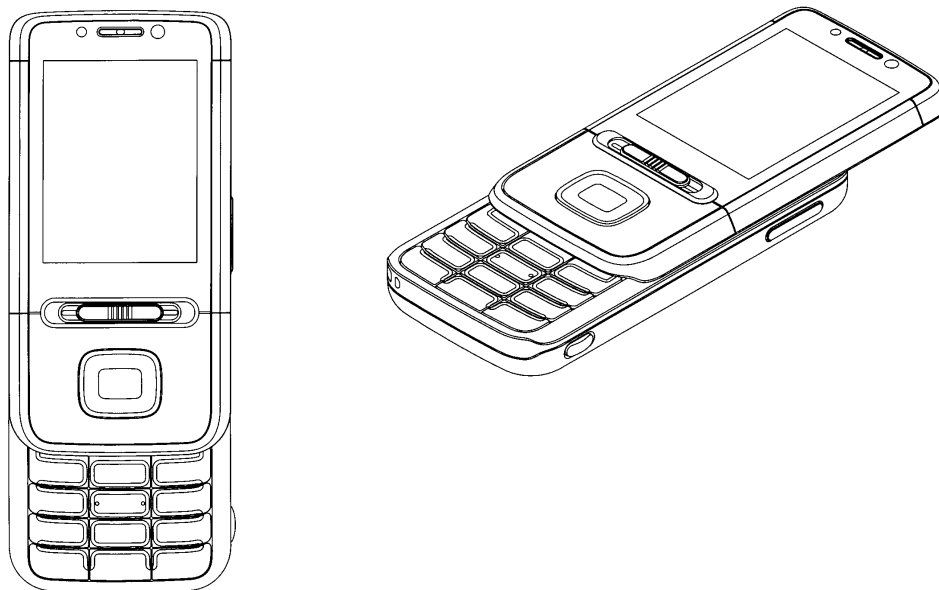

Løbenr. 7

(71) ANSØGER(E): Nokia Corporation, Keilalahdentie 4, FI-02150 Espoo, Finland
(74) FULDMÆGTIG: Sandel, Løje & Wallberg, Frederiksgade 7, 1265 København K, Danmark
(72) FREMBRINGER(E): Rachel Sleight, Flat 3, 20 Darwin Street, London SE17 AHB, Storbritannien
Luke Miles, 32 Hillcrest Road, Acton, London W39RY, Storbritannien
(30) PRIORITET: 2007-06-20 FI M20070121
(22) ANSØGNINGSDATO: 2007-12-19
(18) GYLDIG TIL: 2012-12-19

Offentligt tilgængelige designansøgninger og -registreringer

Akterne i nedenstående ansøgninger eller registreringer er tilgængelige for enhver, jf. § 21, stk. 2, i designlov nr. 1259 af 20. december 2000.

Klasse 14

Udstyr til optagelse og gengivelse af data, telekommunikationsudstyr

(21) DA 2007 00208

(71) ANSØGER(E):

(22) ANSØGNINGSDATO:

(54) En højttaler

Bang & Olufsen A/S, Peter Bangsvej 15, 7600 Struer, Danmark

2007-08-30

Klasse 15

Maskiner (ikke indeholdt i andre klasser)

(21) DA 2007 00209

(71) ANSØGER(E):

(22) ANSØGNINGSDATO:

(54) En lineær aktuator

Linak A/S, Smedevænget 8, Guderup, 6430 Nordborg, Danmark

2007-09-01

Ændringer

Ændringer vedrørende retten til designet, indehaverens navn/firma og adresse, fuldmægtig m.v.

Overdragelser:

(11) DR 2002 00083

Til: (71) CK Holding AB, Box 729, S-169 27 Solna, Sverige

(11) DR 2002 00147

Til: (71) CK Holding AB, Box 729, S-169 27 Solna, Sverige

Fornyelse af designregistreringer

Fornyelse af registreringer foretaget i medfør af § 23, stk. 1, i designlov nr. 1259 af 20. december 2000.

(11) Registreringsnummer	(18) Gyldig til
DR 2003 00206	20130321
DR 2003 00162	20130310
DR 2003 00179	20130313
DR 2003 00175	20130226
DR 2003 00487	20130416
DR 2003 00503	20130303
DR 2003 00259	20130307

Udslettede registreringer

Udslettede registreringer foretaget i medfør af designlov nr. 1259 af 20. december 2000.

- (11) DR 2002 00602
- (11) DR 2003 00420
- (11) DR 2003 00424

Mønster

Ændringer

Ændringer vedrørende retten til mønstret, mønsterhavers navn, bopæl, fulm. m.v.

Overdragelser:

(11) MR 2001 01149

Til: (71) Future Holding B.V., Contactweg 43C, NL-1014 AN Amsterdam, Holland

Fornyelse af mønsterregistreringer

Fornyelse af registreringer foretaget i medfør af lov om mønstre nr. 218 af 27. maj 1970.

(11) Registreringsnummer

MR 1999 00135

MR 1999 00061

MR 1999 00060

MR 1998 00809

(18) Gyldig til

20130526

20130226

20130226

20130306

WIPO Standard 80

INID-koder

Internationally agreed Numbers for the Identification of (bibliographic) data (INID)

- (11) Serial number of the registration
- (15) Date of the registration/Date of the renewal
- (17) Expected duration of the registration/
renewal
- (18) Expected expiration date of the registration/
renewal
- (21) Serial number of the application
- (22) Date of filing of the application
- (23) Name and place of exhibition, and date on
which the industrial design was first
exhibited there (Exhibition priority date)
- (24) Date from which the industrial design right
has effect
- (29) Indication of the form in which the industrial
design is filed, e.g. as a reproduction of the
industrial design or as a specimen thereof
- (30) Data relating to priority under the Paris
Convention
- (43) Date of publication of the industrial design
before examination
- (44) Date of publication of the industrial design
after examination but before registration
- (45) Date of publication of the registered
industrial design
- (46) Date of expiration of deferment
- (51) International Classification for Industrial
Designs (class and subclass of the Locarno
Classification)
- (54) Designation of article(s) or product(s)
covered by the industrial design or title of
the industrial design
- (55) Reproduction of the industrial design (e.g.,
drawing, photograph) and explanations
relating to the reproduction
- (57) Description of characteristic features of the
industrial design including indication of
colors
- (58) Date of recording of any kind of
amendment in the Register
- (62) Serial number(s) and, if available, filing
date(s) of application(s), registration(s) or
document(s) related by division
- (66) Serial number(s) of the application or the
registration of the design(s), which is(are) a
variant(s) of the present one
- (71) Name(s) and address(es) of the appli-
cant(s)
- (72) Name(s) of the creator(s) if known to be
such
- (73) Name(s) and address(es) of the owner(s)
- (74) Name(s) and address(es) of the
representative(s)

Domestic Codes for the Identification of Data

- (DL) Data concerning license
- (DP) Data concerning pawning

Internationalt vedtagne Numre til Identifikation af Data (INID)

Registreringsnummer
Registreringsdato/fornyelsesdato
Forventet registreringsperiode/fornyelsesperiode
Forventet udløbsdato for registrering/fornyelse

Ansøgningsnummer
Ansøgningsdato
Udstillingsnavn og -sted og dato for første udstil-
ling (udstillingsprioritetsoplysninger)

Indleveringsdato

Angivelse af i hvilken form designet er indleveret,
fx som en afbildning af designet eller som en
model heraf
Oplysninger om prioritet efter Pariserkonventionen

Dato for offentlig tilgængelighed

Bekendtgørelsesdato for ansøgningen

Offentliggørelse af registreringen

Udsættelsesdato
International klassifikation af design (klasser og
underklasser i Locarno Klassifikationen)

Vareangivelse/produktangivelse

Afbildninger af designet (fx tegninger, fotografier)
og forklaringer vedrørende afbildningerne

Beskrivelse af karakteristiske træk vedr. designet,
herunder angivelse af farver
Dato for tilførelse til registret

Nummer på hovedansøgning eller udskilt ansøg-
ning

Numre på beslægtede ansøgninger

Ansøgningsnavn og -adresse
Frembringers/designers navn og adresse
Indehavernavn og -adresse
Fuldmægtignavn og -adresse

Interne koder til identifikation af data

Licensoplysninger
Pantoplysninger
Oplysninger om konkurs