



PATENT- OG VAREMÆRKESTYRELSEN

Dansk Design- tidende

Indholdsfortegnelse

Designsager

Offentliggørelse af designregistreringer	60
Offentligt tilgængelige designansøgninger	74
Fornyelse af designregistreringer	75
Udslettelse af designregistreringer	76

Mønstersager

Fornyelse af mønsterregistreringer	81
Inid	82

Dansk Designtidende kan rekvireres som papirkopi for kr. 150 stk. på tlf. 43 50 85 35

Ansvarlig for redaktion: Keld Nymann Jensen
Udgives af Patent- og Varemærkestyrelsen, Helgeshøj Allé 81, 2630 Tåstrup, tlf. 43 50 80 00

ISSN 1601-7374

Design

Offentliggørelse af designregistreringer

Enhver kan anmode om hel- eller delvis udslettelse af en registrering (administrativ prøvning), jf. § 25 i designlov nr. 1259 af 20. december 2000.
En model af designet kan ses i Patent- og Varemærkestyrelsen, hvis det er offentliggjort, at en model er indleveret til styrelsen.
Det er anført, hvis et design er registreret i farve.

(11) DR 2008 00019
(21) DA 2007 00267

(54) En to-personers vante

(51)-Cl.02 06



(71) ANSØGER(E): Karin Linderøth Nielsen, Adellers Allé 102, 4540 Fårevejle, Danmark
Tina Igelsø Mortensen, Chr. Hansensvej 8, 4540 Fårevejle, Danmark
(22) ANSØGNINGSDATO: 2007-11-13
(18) GYLDIG TIL: 2012-11-13

(11) DR 2008 00020
(21) DA 2007 00245

(54) En sko

(51)-Cl.02 04



(71) ANSØGER(E):
(22) ANSØGNINGSDATO:
(18) GYLDIG TIL:

Flex-Foot Footwear A/S, Esbjergvej 101, Harte, 6000 Kolding, Danmark
2007-10-13
2012-10-13

(11) DR 2008 00021
 (21) DA 2008 00001

(54) 1) En holder til et håndsæt; 2) håndfri højttalertelefon (51)-Cl.14 01;14 99

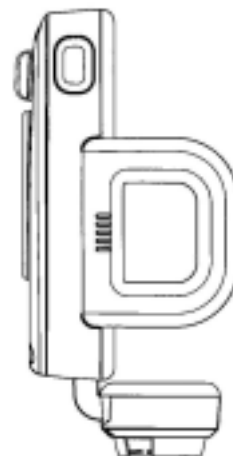
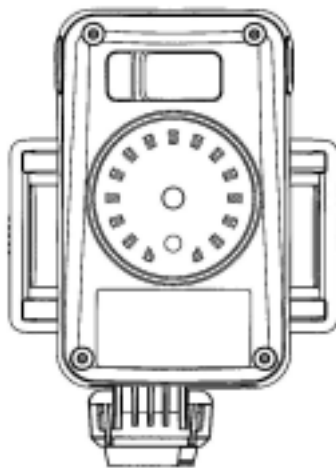
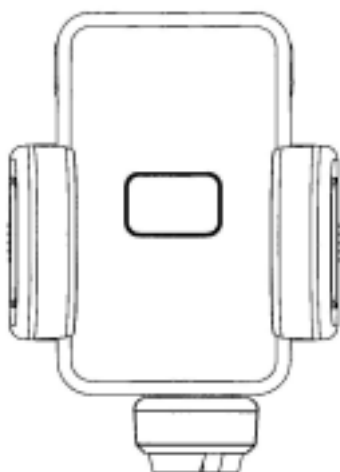

Løbenr. 1

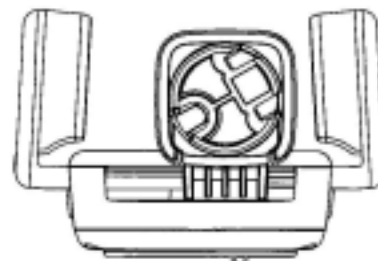
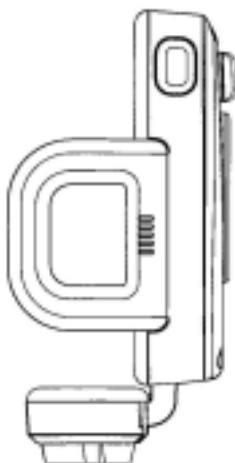

Løbenr. 1

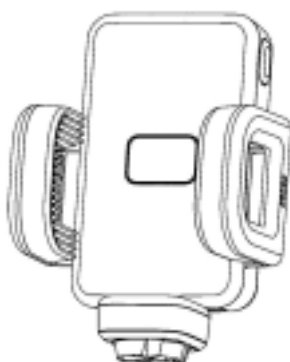

Løbenr. 1



Løbenr. 2



(71) ANSØGER(E):
 (74) FULDMÆGTIG:
 (72) FREMBRINGER(E):

Nokia Corporation, Keilalahdentie 4, FI-02150 Espoo, Finland
 Sandel, Løje & Wallberg, Frederiksgade 7, 1265 København K, Danmark
 Sami Lehtovaara, Suovasentie 52, FIN-21250 Masku, Finland
 Mika Moilanen, c/o Nokia Corporation, Keilalahdentie 4, Espoo, FIN-02150, Finland
 Jan Kettula, Leppävaarankatu 17 E 30, FIN-02600 Espoo, Finland
 2007-07-04 FI M20070132
 2008-01-04
 2013-01-04

(30) PRIORITET:
 (22) ANSØGNINGSDATO:
 (18) GYLDIG TIL:

(11) DR 2008 00022

(54) 1) Et håndsæt 2) håndsæts tastaturknapper 3) del af et håndsæt
4) håndsæts frontdel

(51)-Cl.14 03

(21) DA 2007 00307

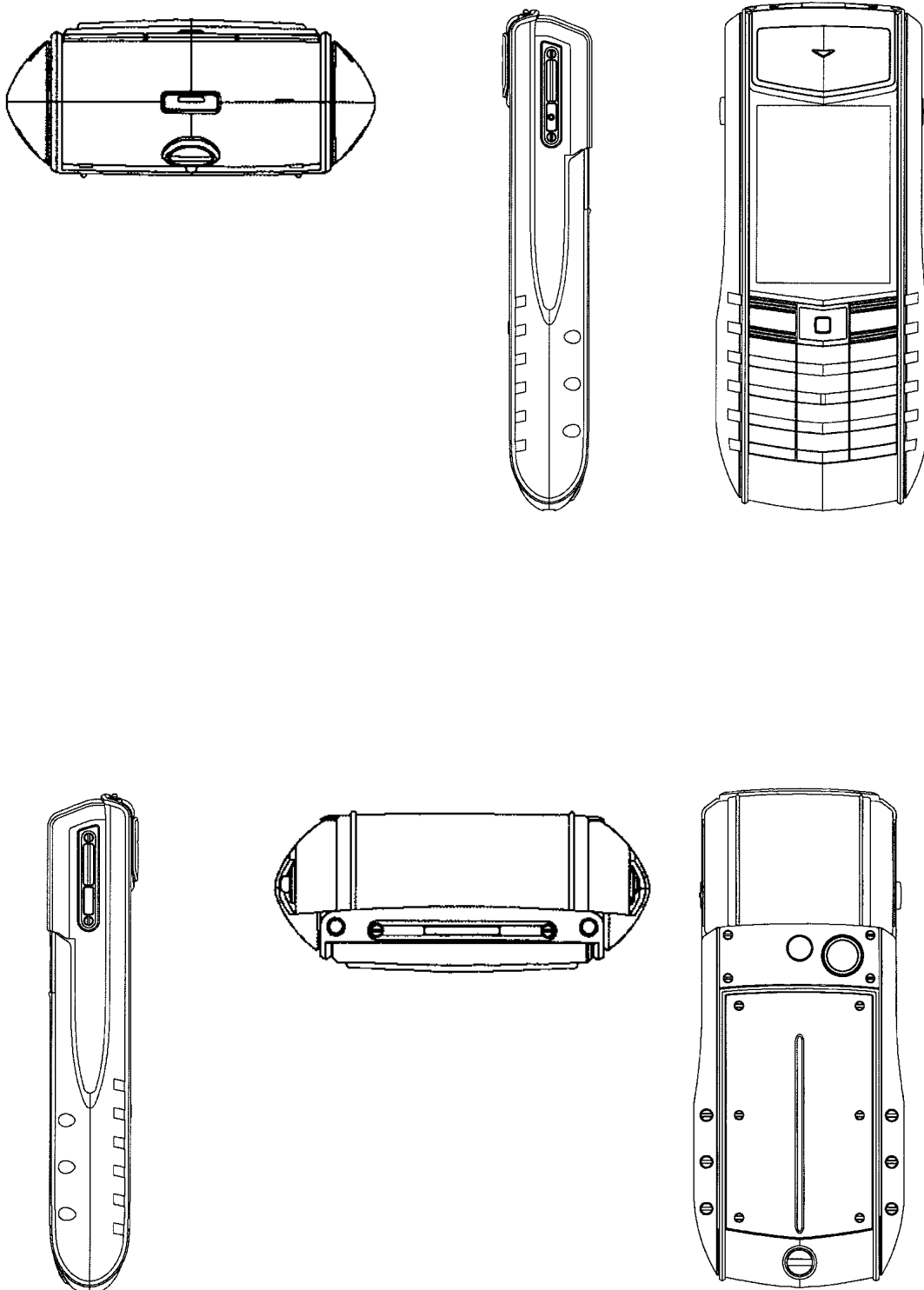

Løbenr. 1

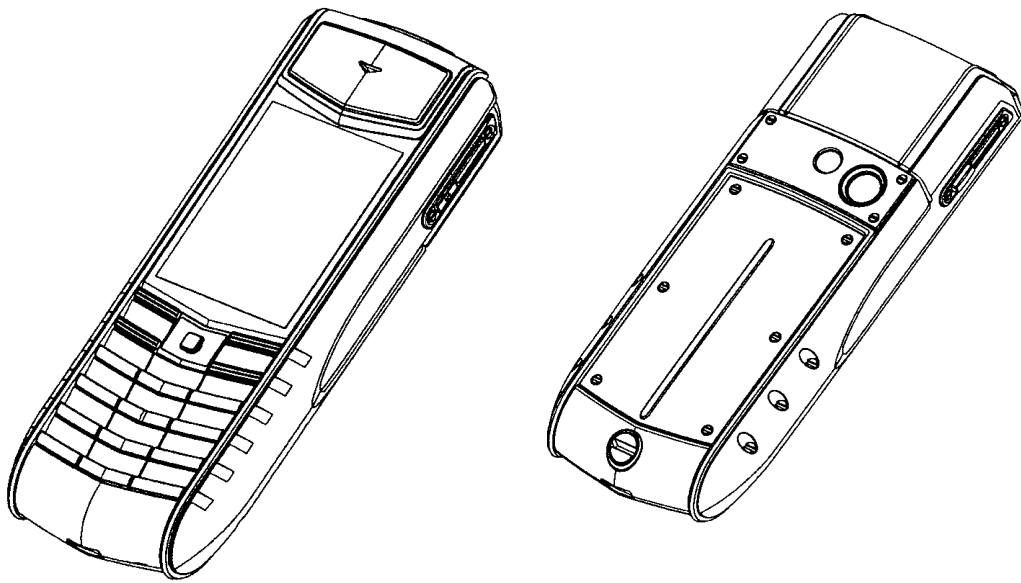

Løbenr. 1

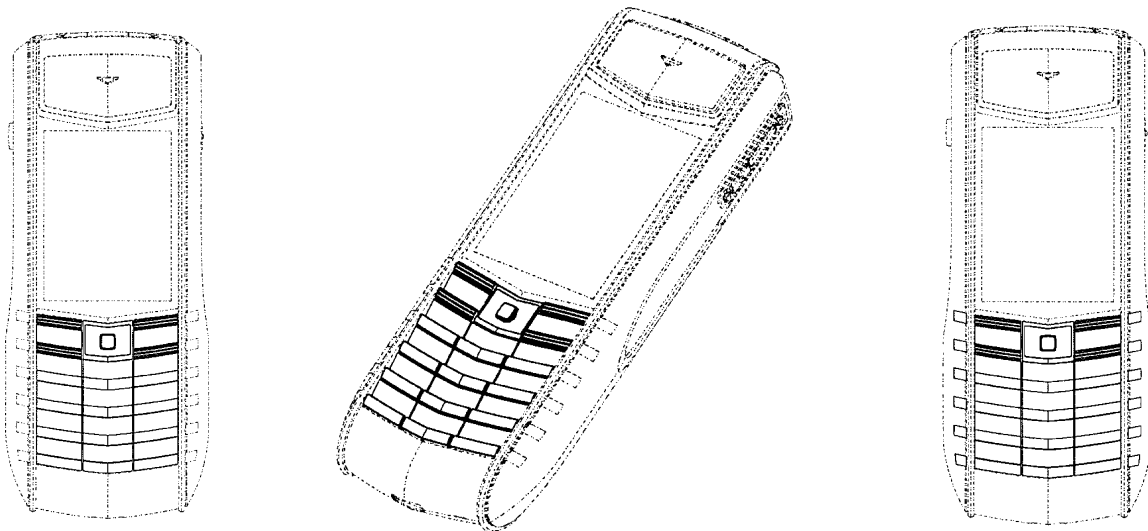

Løbenr. 2

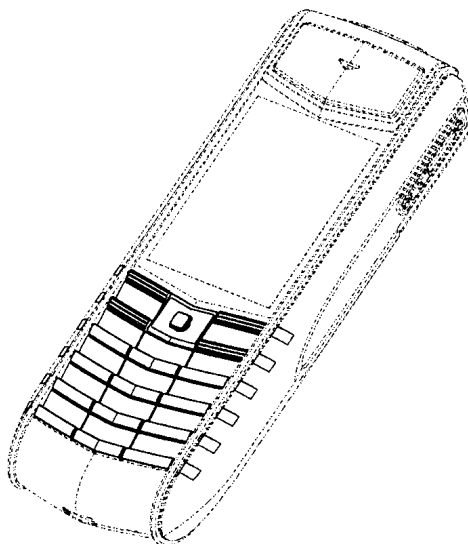

Løbenr. 2

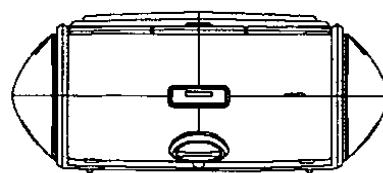

Løbenr. 3

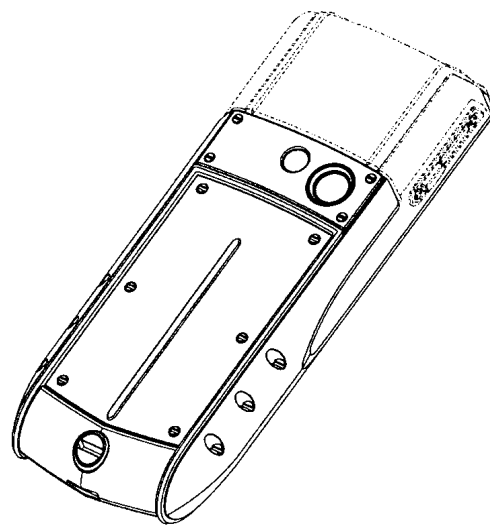
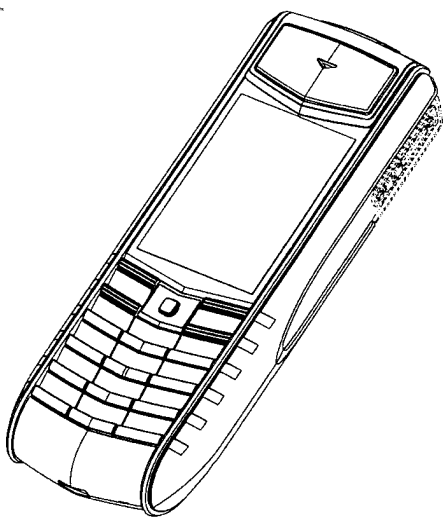
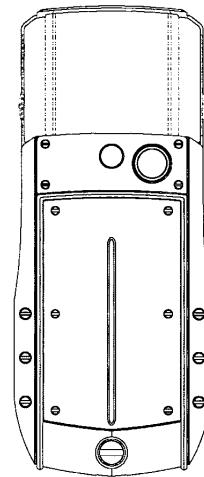
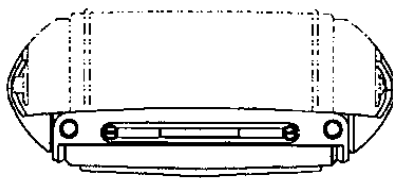
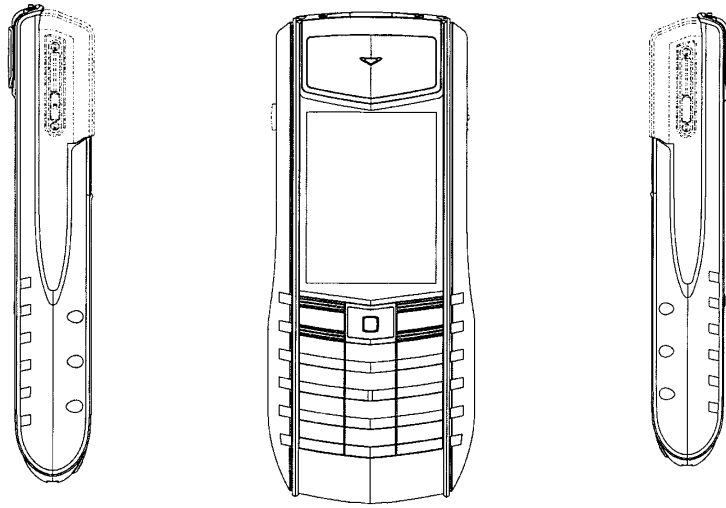

Løbenr. 3

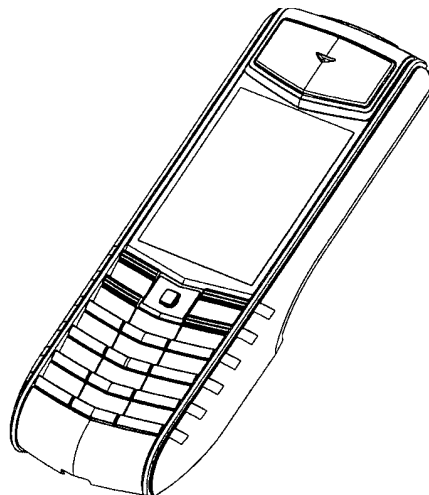
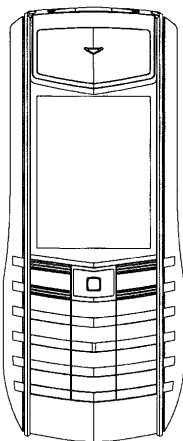
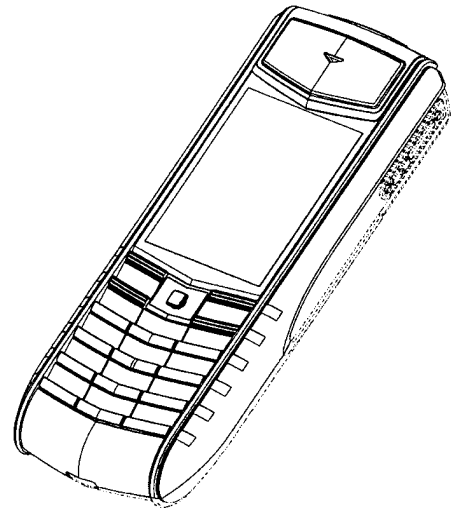
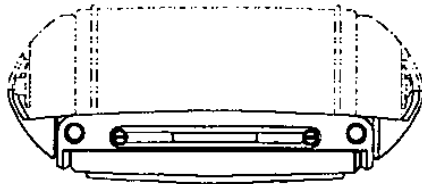
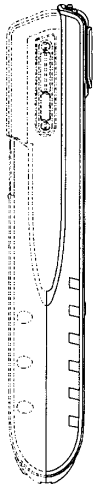
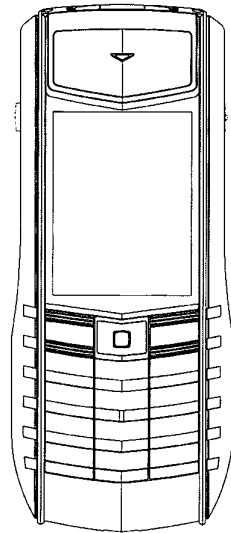
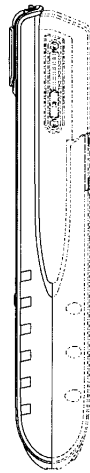
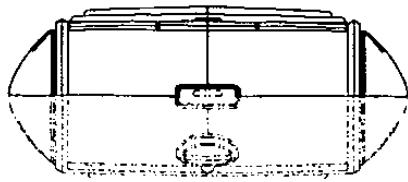

Løbenr. 4

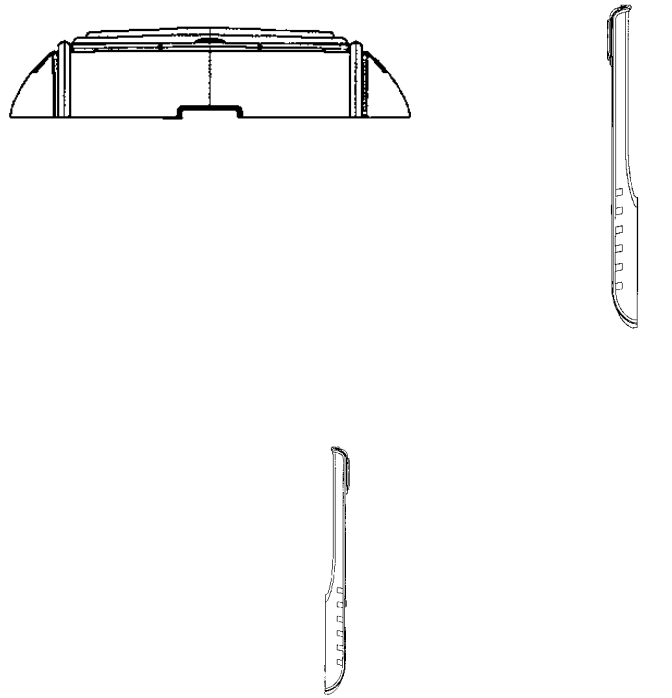

Løbenr. 4

(71) ANSØGER(E):	Nokia Corporation, Keilalahdentie 4, FI-02150 Espoo, Finland
(74) FULDMÆGTIG:	Sandel, Løje & Wallberg, Frederiksgade 7, 1265 København K, Danmark
(72) FREMBRINGER(E):	Frank Nuovo, 1612 Stradella Road, Los Angeles, California 90077, USA
(30) PRIORITET:	2007-06-20 US 29/281,278
(22) ANSØGNINGSDATO:	2007-12-19
(18) GYLDIG TIL:	2012-12-19

(11) DR 2008 00023
(21) DA 2007 00312

(54) 1-4) En bokseballage

(51)-Cl.09 03;09 05

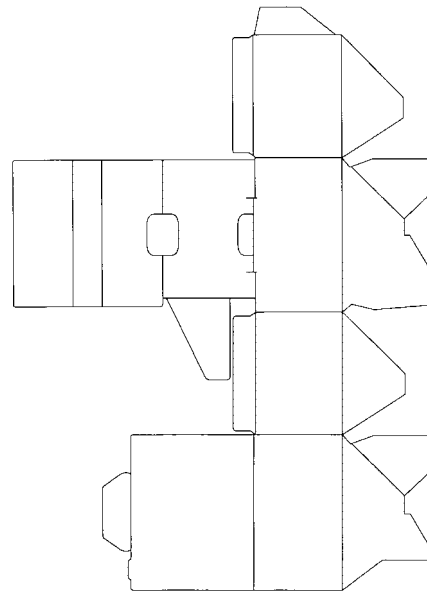
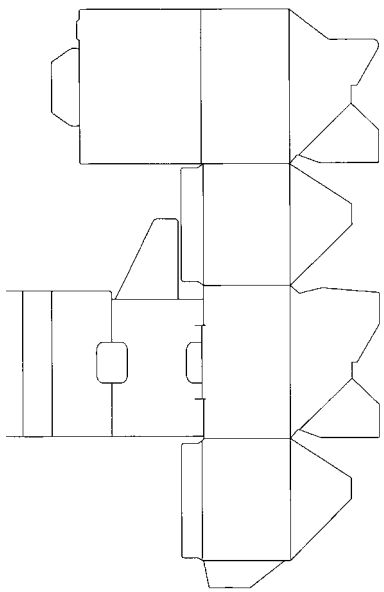

Løbenr. 1

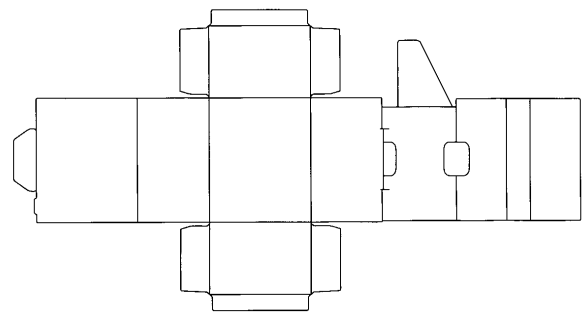
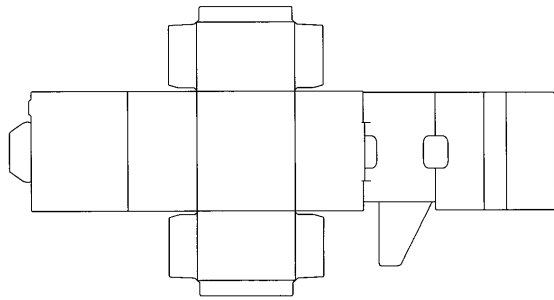

Løbenr. 2

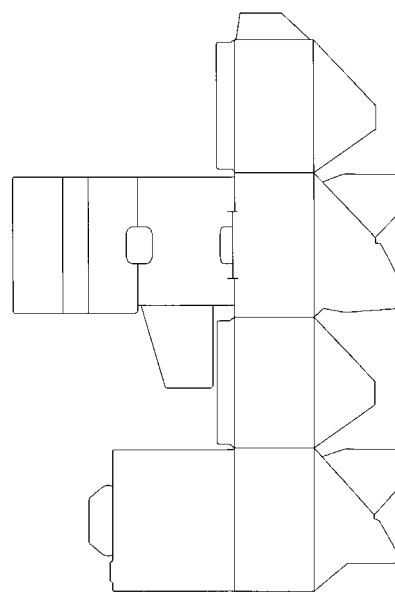
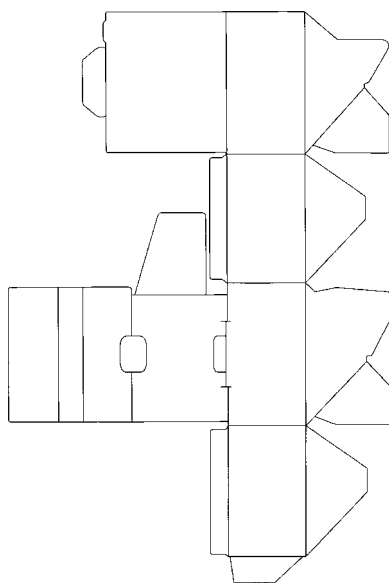

Løbenr. 3

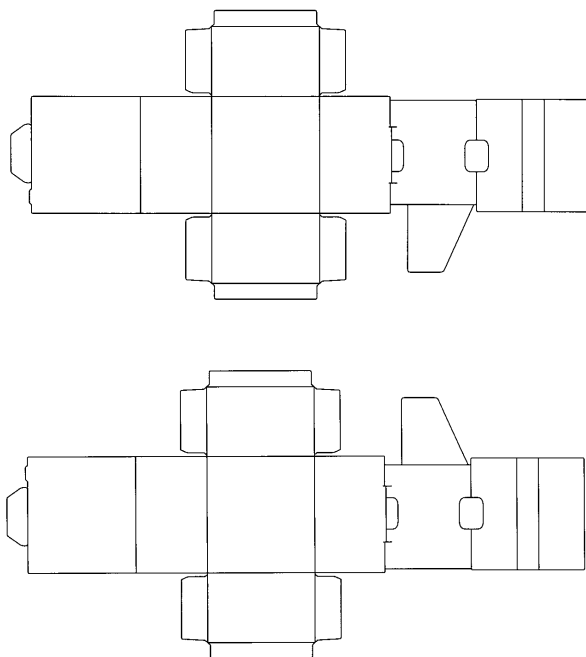

Løbenr. 4

(71) ANSØGER(E): Nokia Corporation, Keilalahdentie 4, FI-02150 Espoo, Finland
 (74) FULDMÆGTIG: Sandel, Løje & Wallberg, Frederiksgade 7, 1265 København K, Danmark
 (72) FREMBRINGER(E): Birgir Magnusson, Karolinervägen 17, bost 1, F1-10330 Billnäs, Finland
 (30) PRIORITET: 2007-06-25 FI M20070127
 (22) ANSØGNINGSDATO: 2007-12-27
 (18) GYLDIG TIL: 2012-12-27

(11) DR 2008 00024
 (21) DA 2007 00278

(54) En holder med sugekop til papirvarer

(51)-Cl.20 03

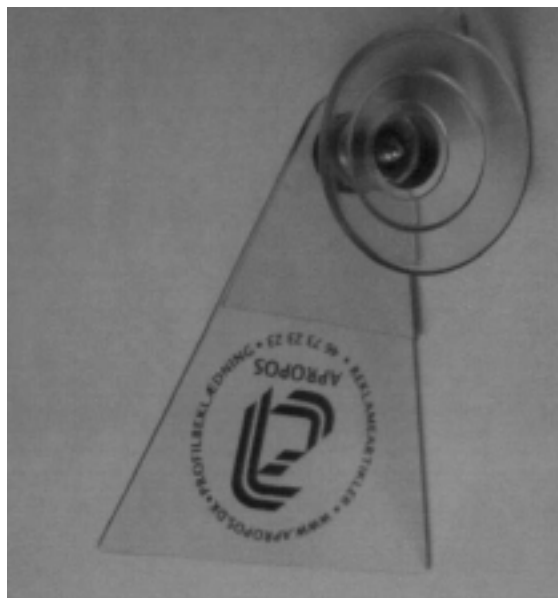

(71) ANSØGER(E): Morten Harholt Bang, Esmarcksvej 3, 8550 Ryomgård, Danmark
 Jan Lundgaard Bach, Skolegade 1, 8550 Ryomgård, Danmark
 (72) FREMBRINGER(E): Morten Harholt Bang, Esmarcksvej 3, 8550 Ryomgård, Danmark
 Jan Lundgaard Bach, Skolegade 1, 8550 Ryomgård, Danmark
 (22) ANSØGNINGSDATO: 2007-11-20
 (18) GYLDIG TIL: 2012-11-20

(11) DR 2008 00025
(21) DA 2007 00279

(54) En ledningsholder

(51)-Cl.13 03;14 03

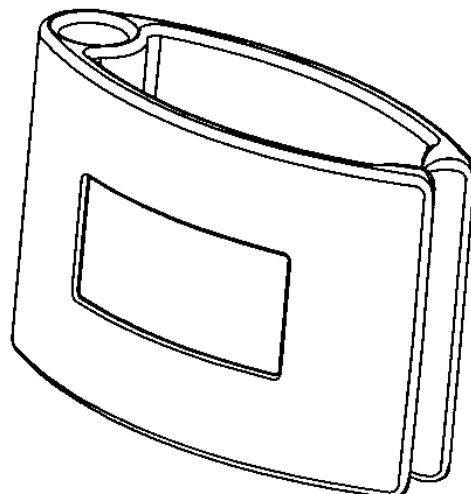
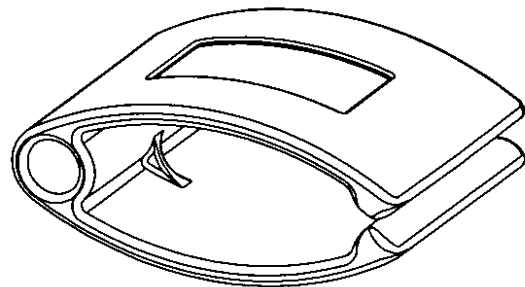
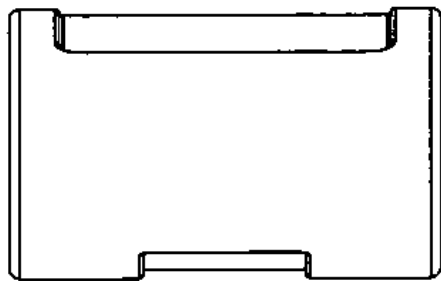
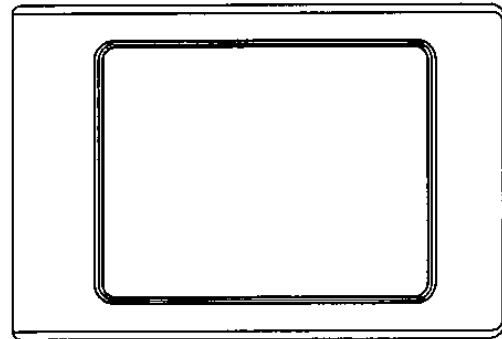
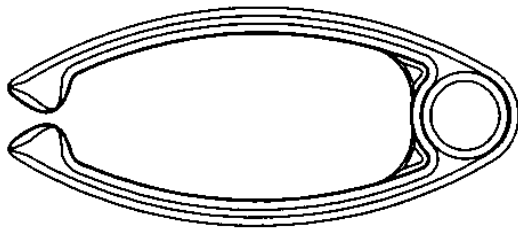
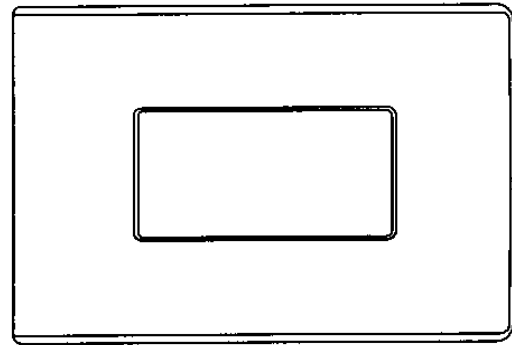
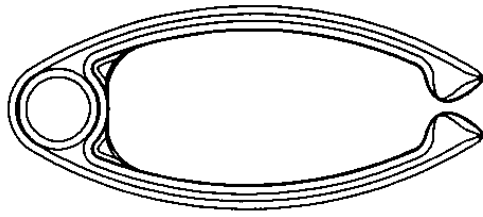

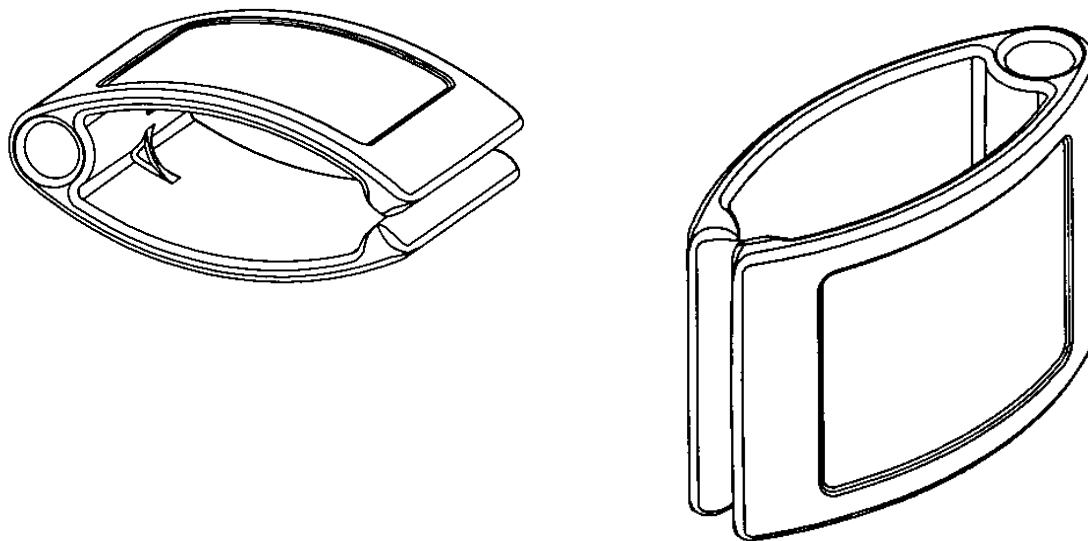

(71) ANSØGER(E): Nokia Corporation, Keilalahdentie 4, FI-02150 Espoo, Finland
 (74) FULDMÆGTIG: Sandel, Løje & Wallberg, Frederiksgade 7, 1265 København K, Danmark
 (30) PRIORITET: 2007-05-25 FI M20070101
 (22) ANSØGNINGSDATO: 2007-11-22
 (18) GYLDIG TIL: 2012-11-22

(11) DR 2008 00026
 (21) DA 2007 00242

(54) En halogenhavelampe

(51)-Cl.26 03

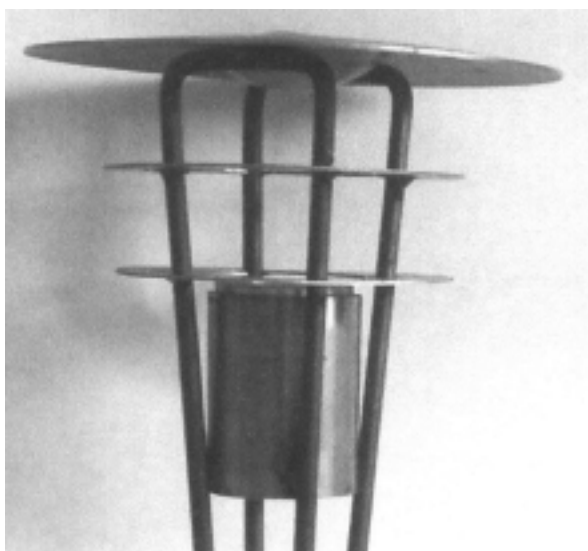

(71) ANSØGER(E): DESIGN OG ANLÆG/ BENT ERIK SESLEF, Mølleløkken 3, 5270 Odense N, Danmark
 (72) FREMBRINGER(E): DESIGN OG ANLÆG/ BENT ERIK SESLEF, Mølleløkken 3, 5270 Odense N, Danmark
 (22) ANSØGNINGSDATO: 2007-10-08
 (18) GYLDIG TIL: 2012-10-08

(11) DR 2008 00027
(21) DA 2007 00232

(54) En sofa

(51)-Cl.06 01

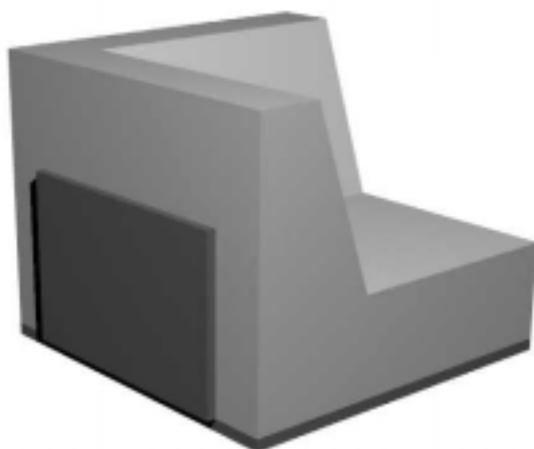
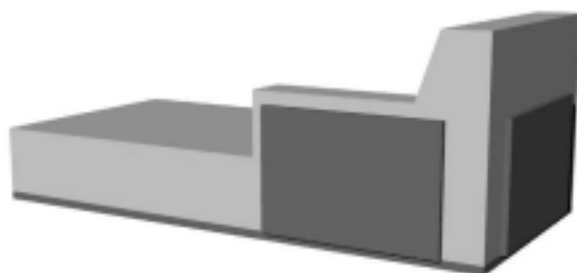
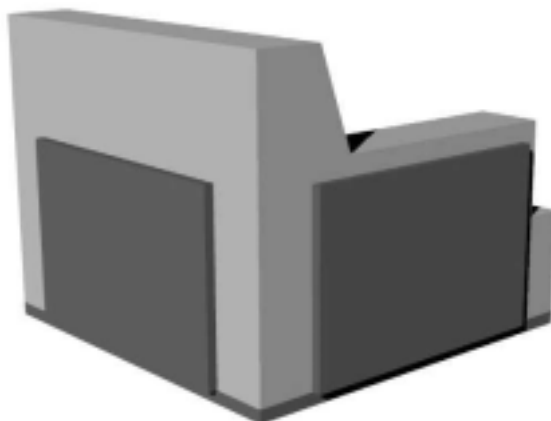

(71) ANSØGER(E):
(22) ANSØGNINGSDATO:
(18) GYLDIG TIL:

HENRIK HAMMER ApS, Gammel Kongevej 142, 4. th, 1850 Frederiksberg C, Danmark
2007-09-19
2012-09-19

(11) DR 2008 00028
(21) DA 2007 00246

(54) En delbar grill

(51)-Cl.07 02

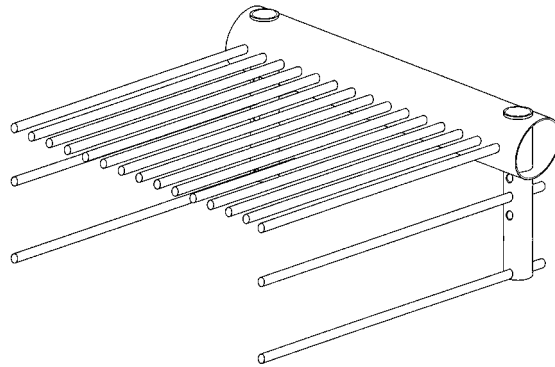

(71) ANSØGER(E): Jørn Falkenberg, Grejs Bakke 13 C, 4. th, 7100 Vejle, Danmark
Mogens Falkenberg, Østerled 1, 6510 Gram, Danmark
(72) FREMBRINGER(E): Jørn Falkenberg, Grejs Bakke 13 C, 4. th, 7100 Vejle, Danmark
(22) ANSØGNINGSDATO: 2007-10-15
(18) GYLDIG TIL: 2012-10-15

Offentligt tilgængelige designansøgninger og -registreringer

Akterne i nedenstående ansøgninger eller registreringer er tilgængelige for enhver, jf. § 21, stk. 2, i designlov nr. 1259 af 20. december 2000.

Klasse 14

Udstyr til optagelse og gengivelse af data, telekommunikationsudstyr

(21) DA 2007 00179

(71) ANSØGER(E):

(22) ANSØGNINGSDATO:

(54) 1) Håndsæt

Nokia Corporation, Keilalahdentie 4, FI-02150 Espoo, Finland

2007-07-24

Fornyelse af designregistreringer

Fornyelse af registreringer foretaget i medfør af § 23, stk. 1, i designlov nr. 1259 af 20. december 2000.

(11) Registreringsnummer	(18) Gyldig til
DR 2003 00093	20130121
DR 2003 00285	20130122
DR 2003 00293	20130131
DR 2003 00123	20130122
DR 2003 00144	20130123
DR 2003 00143	20130123
DR 2003 00105	20130211
DR 2003 00145	20130127
DR 2002 00691	20120801
DR 2002 00690	20120801
DR 2003 00087	20130130
DR 2003 00088	20130131
DR 2003 00089	20130131
DR 2003 00174	20130127
DR 2003 00350	20130128
DR 2003 00381	20130130
DR 2003 00358	20130109
DR 2003 00418	20130226
DR 2003 00242	20130213
DR 2003 00125	20130213
DR 2003 00151	20130130

Udslettede registreringer

Udslettede registreringer foretaget i medfør af designlov nr. 1259 af 20. december 2000.

(11) DR 2001 00019
(11) DR 2002 00009
(11) DR 2001 00006
(11) DR 2001 00005
(11) DR 2002 00149
(11) DR 2002 00088
(11) DR 2002 00002
(11) DR 2001 00003
(11) DR 2001 00022
(11) DR 2002 00207
(11) DR 2001 00029
(11) DR 2002 00217
(11) DR 2002 00016
(11) DR 2001 00017
(11) DR 2001 00018
(11) DR 2001 00007
(11) DR 2001 00079
(11) DR 2001 00023
(11) DR 2002 00001
(11) DR 2002 00327
(11) DR 2001 00070
(11) DR 2001 00061
(11) DR 2001 00024
(11) DR 2001 00026
(11) DR 2002 00059
(11) DR 2002 00254
(11) DR 2001 00028
(11) DR 2002 00041
(11) DR 2002 00091
(11) DR 2002 00039
(11) DR 2001 00033
(11) DR 2002 00282
(11) DR 2001 00036
(11) DR 2002 00043
(11) DR 2001 00057
(11) DR 2001 00058
(11) DR 2002 00063
(11) DR 2001 00042
(11) DR 2002 00058
(11) DR 2001 00068
(11) DR 2001 00067
(11) DR 2002 00086
(11) DR 2002 00004
(11) DR 2002 00274
(11) DR 2002 00097
(11) DR 2002 00099
(11) DR 2002 00137
(11) DR 2002 00309
(11) DR 2002 00306
(11) DR 2002 00640
(11) DR 2002 00023
(11) DR 2002 00098
(11) DR 2002 00107
(11) DR 2002 00020
(11) DR 2002 00198
(11) DR 2001 00056
(11) DR 2002 00174
(11) DR 2001 00074
(11) DR 2001 00064
(11) DR 2001 00065
(11) DR 2002 00333
(11) DR 2002 00206
(11) DR 2002 00072
(11) DR 2002 00096
(11) DR 2002 00062
(11) DR 2002 00008
(11) DR 2002 00092
(11) DR 2002 00085
(11) DR 2002 00093
(11) DR 2002 00185
(11) DR 2002 00018

(11) DR 2002 00152
(11) DR 2002 00061
(11) DR 2002 00121
(11) DR 2002 00060
(11) DR 2002 00047
(11) DR 2002 00048
(11) DR 2002 00049
(11) DR 2002 00351
(11) DR 2002 00392
(11) DR 2002 00246
(11) DR 2002 00141
(11) DR 2002 00024
(11) DR 2002 00034
(11) DR 2002 00342
(11) DR 2002 00032
(11) DR 2002 00150
(11) DR 2002 00070
(11) DR 2002 00074
(11) DR 2002 00153
(11) DR 2002 00249
(11) DR 2002 00035
(11) DR 2002 00027
(11) DR 2002 00031
(11) DR 2002 00171
(11) DR 2002 00054
(11) DR 2002 00109
(11) DR 2002 00168
(11) DR 2002 00334
(11) DR 2002 00176
(11) DR 2002 00089
(11) DR 2002 00087
(11) DR 2002 00064
(11) DR 2002 00238
(11) DR 2002 00101
(11) DR 2002 00166
(11) DR 2002 00453
(11) DR 2002 00454
(11) DR 2002 00077
(11) DR 2002 00458
(11) DR 2002 00069
(11) DR 2002 00094
(11) DR 2002 00480
(11) DR 2002 00481
(11) DR 2002 00478
(11) DR 2002 00479
(11) DR 2002 00228
(11) DR 2002 00269
(11) DR 2002 00076
(11) DR 2002 00409
(11) DR 2002 00411
(11) DR 2002 00418
(11) DR 2002 00202
(11) DR 2002 00396
(11) DR 2002 00178
(11) DR 2002 00080
(11) DR 2002 00410
(11) DR 2002 00160
(11) DR 2002 00078
(11) DR 2002 00079
(11) DR 2002 00210
(11) DR 2002 00081
(11) DR 2002 00331
(11) DR 2002 00110
(11) DR 2002 00483
(11) DR 2002 00180
(11) DR 2002 00267
(11) DR 2002 00529
(11) DR 2002 00118
(11) DR 2002 00120
(11) DR 2002 00115
(11) DR 2002 00357
(11) DR 2002 00173

(11) DR 2002 00105
(11) DR 2002 00104
(11) DR 2002 00136
(11) DR 2002 00367
(11) DR 2002 00102
(11) DR 2002 00131
(11) DR 2002 00535
(11) DR 2002 00536
(11) DR 2002 00286
(11) DR 2002 00252
(11) DR 2002 00127
(11) DR 2002 00155
(11) DR 2002 00123
(11) DR 2002 00472
(11) DR 2002 00261
(11) DR 2002 00122
(11) DR 2002 00412
(11) DR 2002 00429
(11) DR 2002 00561
(11) DR 2002 00167
(11) DR 2002 00142
(11) DR 2002 00144
(11) DR 2002 00787
(11) DR 2002 00156
(11) DR 2002 00157
(11) DR 2002 00209
(11) DR 2002 00580
(11) DR 2002 00633
(11) DR 2002 00297
(11) DR 2002 00162
(11) DR 2002 00182
(11) DR 2002 00183
(11) DR 2002 00165
(11) DR 2002 00190
(11) DR 2002 00193
(11) DR 2002 00601
(11) DR 2002 00203
(11) DR 2002 00216
(11) DR 2002 00393
(11) DR 2002 00276
(11) DR 2002 00268
(11) DR 2002 00319
(11) DR 2002 00359
(11) DR 2002 00358
(11) DR 2002 00380
(11) DR 2002 00189
(11) DR 2002 00227
(11) DR 2002 00200
(11) DR 2002 00201
(11) DR 2002 00664
(11) DR 2002 00271
(11) DR 2002 00229
(11) DR 2002 00248
(11) DR 2002 00212
(11) DR 2002 00672
(11) DR 2002 00362
(11) DR 2002 00402
(11) DR 2002 00225
(11) DR 2002 00408
(11) DR 2002 00477
(11) DR 2002 00476
(11) DR 2002 00304
(11) DR 2002 00303
(11) DR 2002 00612
(11) DR 2002 00394
(11) DR 2002 00670
(11) DR 2002 00291
(11) DR 2002 00262
(11) DR 2002 00247
(11) DR 2002 00284
(11) DR 2002 00285
(11) DR 2002 00668

(11) DR 2002 00565
(11) DR 2002 00264
(11) DR 2002 00280
(11) DR 2002 00279
(11) DR 2002 00730
(11) DR 2002 00718
(11) DR 2002 00266
(11) DR 2002 00443
(11) DR 2002 00263
(11) DR 2002 00293
(11) DR 2002 00473
(11) DR 2002 00474
(11) DR 2002 00341
(11) DR 2002 00457
(11) DR 2002 00272
(11) DR 2002 00273
(11) DR 2002 00738
(11) DR 2002 00326
(11) DR 2003 00079
(11) DR 2002 00374
(11) DR 2002 00340
(11) DR 2002 00343
(11) DR 2002 00434
(11) DR 2002 00301
(11) DR 2002 00368
(11) DR 2002 00768
(11) DR 2002 00531
(11) DR 2002 00762
(11) DR 2002 00417
(11) DR 2002 00401
(11) DR 2002 00780
(11) DR 2002 00344
(11) DR 2002 00460
(11) DR 2002 00465
(11) DR 2002 00338
(11) DR 2002 00328
(11) DR 2003 00098
(11) DR 2002 00507
(11) DR 2002 00354
(11) DR 2002 00807
(11) DR 2002 00532
(11) DR 2002 00511
(11) DR 2002 00346
(11) DR 2002 00816
(11) DR 2002 00373
(11) DR 2002 00428
(11) DR 2002 00470
(11) DR 2002 00366
(11) DR 2002 00405
(11) DR 2002 00413
(11) DR 2002 00832
(11) DR 2002 00395
(11) DR 2002 00400
(11) DR 2002 00423
(11) DR 2002 00847
(11) DR 2002 00494
(11) DR 2002 00464
(11) DR 2002 00397
(11) DR 2002 00422
(11) DR 2002 00624
(11) DR 2002 00459
(11) DR 2003 00281
(11) DR 2003 00115
(11) DR 2003 00341

Mønster

Fornyelse af mønsterregistreringer

Fornyelse af registreringer foretaget i medfør af lov om mønstre nr. 218 af 27. maj 1970.

(11) Registreringsnummer	(18) Gyldig til
MR 1999 00096	20130305
MR 1998 00641	20130129
MR 1998 00699	20130130
MR 1998 00765	20130210
MR 1998 00715	20130213
MR 1998 00717	20130213
MR 1998 00716	20130213
MR 1998 00766	20130211
MR 1999 00005	20130408

WIPO Standard 80

INID-koder

Internationally agreed Numbers for the Identification of (bibliographic) data (INID)

- (11) Serial number of the registration
- (15) Date of the registration/Date of the renewal
- (17) Expected duration of the registration/
renewal
- (18) Expected expiration date of the registration/
renewal
- (21) Serial number of the application
- (22) Date of filing of the application
- (23) Name and place of exhibition, and date on
which the industrial design was first
exhibited there (Exhibition priority date)
- (24) Date from which the industrial design right
has effect
- (29) Indication of the form in which the industrial
design is filed, e.g. as a reproduction of the
industrial design or as a specimen thereof
- (30) Data relating to priority under the Paris
Convention
- (43) Date of publication of the industrial design
before examination
- (44) Date of publication of the industrial design
after examination but before registration
- (45) Date of publication of the registered
industrial design
- (46) Date of expiration of deferment
- (51) International Classification for Industrial
Designs (class and subclass of the Locarno
Classification)
- (54) Designation of article(s) or product(s)
covered by the industrial design or title of
the industrial design
- (55) Reproduction of the industrial design (e.g.,
drawing, photograph) and explanations
relating to the reproduction
- (57) Description of characteristic features of the
industrial design including indication of
colors
- (58) Date of recording of any kind of
amendment in the Register
- (62) Serial number(s) and, if available, filing
date(s) of application(s), registration(s) or
document(s) related by division
- (66) Serial number(s) of the application or the
registration of the design(s), which is(are) a
variant(s) of the present one
- (71) Name(s) and address(es) of the appli-
cant(s)
- (72) Name(s) of the creator(s) if known to be
such
- (73) Name(s) and address(es) of the owner(s)
- (74) Name(s) and address(es) of the
representative(s)

Domestic Codes for the Identification of Data

- (DL) Data concerning license
- (DP) Data concerning pawning

Internationalt vedtagne Numre til Identifikation af Data (INID)

Registreringsnummer
Registreringsdato/fornyelsesdato
Forventet registreringsperiode/fornyelsesperiode
Forventet udløbsdato for registrering/fornyelse

Ansøgningsnummer
Ansøgningsdato
Udstillingsnavn og -sted og dato for første udstil-
ling (udstillingsprioritetsoplysninger)

Indleveringsdato

Angivelse af i hvilken form designet er indleveret,
fx som en afbildning af designet eller som en
model heraf
Oplysninger om prioritet efter Pariserkonventionen

Dato for offentlig tilgængelighed

Bekendtgørelsesdato for ansøgningen

Offentliggørelse af registreringen

Udsættelsesdato
International klassifikation af design (klasser og
underklasser i Locarno Klassifikationen)

Vareangivelse/produktangivelse

Afbildninger af designet (fx tegninger, fotografier)
og forklaringer vedrørende afbildningerne

Beskrivelse af karakteristiske træk vedr. designet,
herunder angivelse af farver
Dato for tilførsel til registret

Nummer på hovedansøgning eller udskilt ansøg-
ning

Numre på beslægtede ansøgninger

Ansøgners navn og -adresse
Frembringers/designers navn og adresse
Indehavernavn og -adresse
Fuldmægtignavn og -adresse

Interne koder til identifikation af data

Licensoplysninger
Pantoplysninger
Oplysninger om konkurs