



PATENT- OG VAREMÆRKESTYRELSEN

# Dansk Design- tidende

## Indholdsfortegnelse

Designsager .....	513
Offentliggørelse af designregistreringer .....	514
Offentligt tilgængelige designansøgninger .....	539
Henlagte, afslåede eller tilbagetagne designansøgninger .....	540
Ændringer til design .....	541
Fornyelse af designregistreringer .....	542
Udslettelse af designregistreringer .....	543
Mønstersager .....	544
Ændringer til mønstre .....	545
Fornyelse af mønsterregistreringer .....	546
Udslettelse af mønsterregistreringer .....	547
Andre meddelelser .....	548

Dansk Designtidende kan rekvireres som papirkopi for kr. 150 stk. på tlf. 43 50 85 35

Ansvarlig for redaktion: Keld Nymann Jensen  
Udgives af Patent- og Varemærkestyrelsen, Helgeshøj Allé 81, 2630 Tåstrup, tlf. 43 50 80 00

ISSN 1601-7374

Design

## Offentliggørelse af designregistreringer

Enhver kan anmode om hel- eller delvis udslettelse af en registrering (administrativ prøvning), jf. § 25 i designlov nr. 1259 af 20. december 2000.  
En model af designet kan ses i Patent- og Varemærkestyrelsen, hvis det er offentliggjort, at en model er indleveret til styrelsen.  
Det er anført, hvis et design er registreret i farve.

(11) DR 2007 00244  
(21) DA 2007 00113

(54) Et krus

(51)-Cl.07 01



(71) ANSØGER(E):  
(74) FULDMÆGTIG:  
(22) ANSØGNINGSDATO:  
(18) GYLDIG TIL:

Pi-Design AG, Kantonsstrasse 100, CH-6234 Triengen, Schweiz  
Gorrissen Federspiel Kierkegaard, H.C. Andersens Boulevard 12, 1553 København V, Danmark  
2007-05-03  
2012-05-03

(11) DR 2007 00245  
(21) DA 2007 00155

(54) En grebsprofil med skiltning til hospitaler

(51)-Cl.06 06;24 01

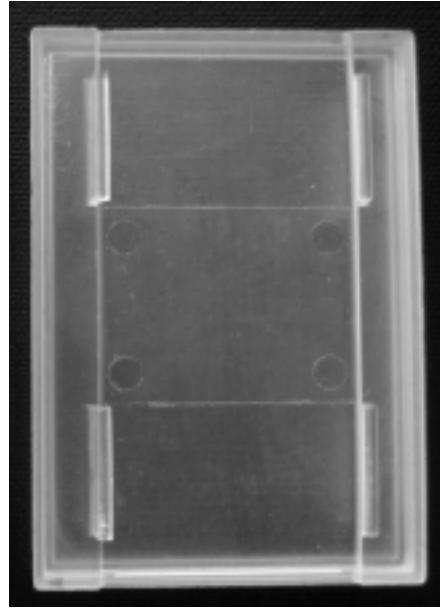

(71) ANSØGER(E): ZYSTM A/S, Hedemølle Erhvervsvej 23, 8850 Bjerringbro, Danmark  
(72) FREMBRINGER(E): AARHUS ARKITEKTERNE A/S, Europaplads 16, 8000 Århus C, Danmark  
(22) ANSØGNINGSDATO: 2007-06-25  
(18) GYLDIG TIL: 2012-06-25

(11) DR 2007 00246  
(21) DA 2007 00118

(54) En istekande

(51)-Cl.07 01

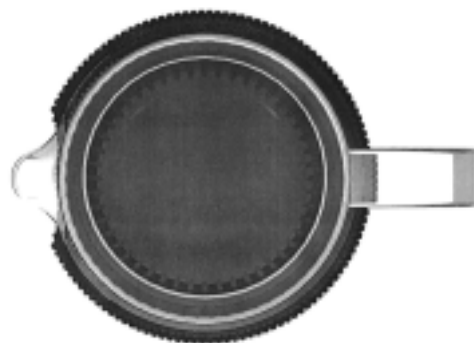
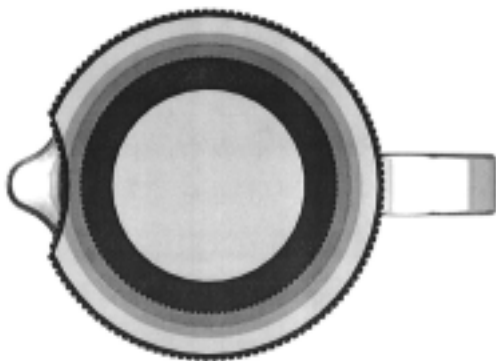
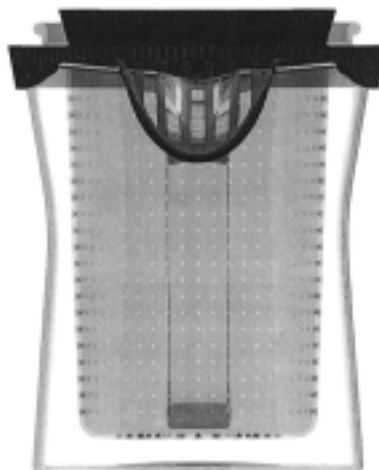
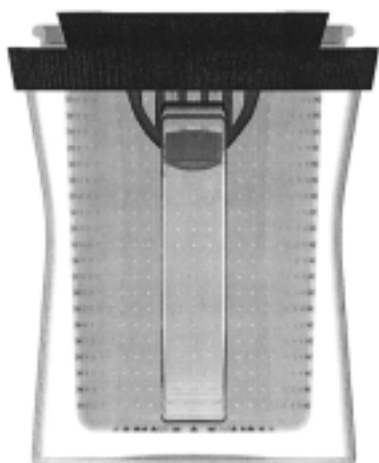
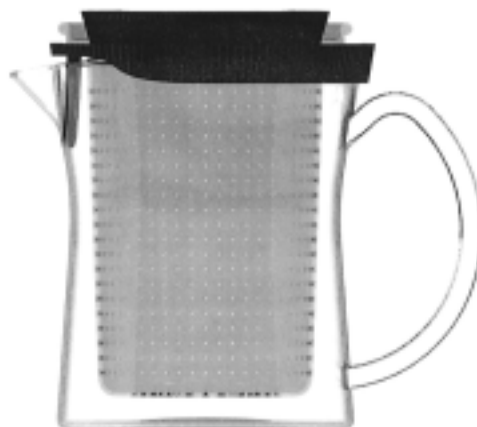

(71) ANSØGER(E):  
(74) FULDMÆGTIG:  
(22) ANSØGNINGSDATO:  
(18) GYLDIG TIL:

Pi-Design AG, Kantonsstrasse 100, CH-6234 Triengen, Schweiz  
Gorrissen Federspiel Kierkegaard, H.C. Andersens Boulevard 12, 1553 København V, Danmark  
2007-05-07  
2012-05-07

(11) DR 2007 00247  
(21) DA 2007 00120

(54) 1-2) Dobbeltvægget glas

(51)-Cl.07 01

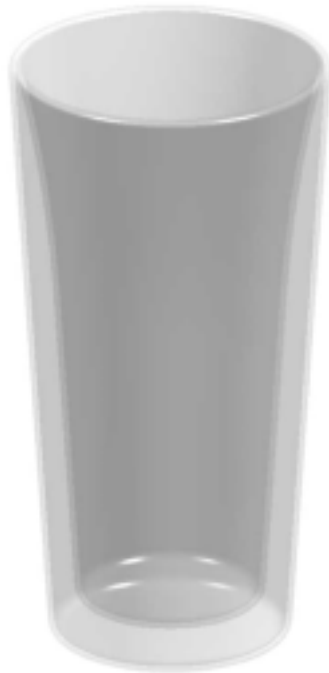

Løbenr. 1



Løbenr. 2

(71) ANSØGER(E):  
(74) FULDMÆGTIG:  
(22) ANSØGNINGSDATO:  
(18) GYLDIG TIL:

Pi-Design AG, Kantonsstrasse 100, CH-6234 Triengen, Schweiz  
Gorrissen Federspiel Kierkegaard, H.C. Andersens Boulevard 12, 1553 København V, Danmark  
2007-05-08  
2012-05-08



(11) DR 2007 00248  
(21) DA 2007 00122

(54) En kop

(51)-Cl.07 01

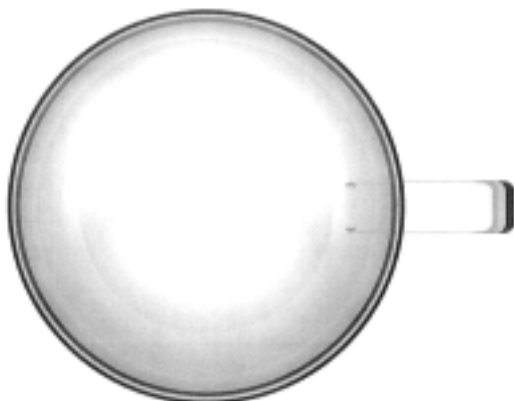

(71) ANSØGER(E):  
(74) FULDMÆGTIG:  
(22) ANSØGNINGSDATO:  
(18) GYLDIG TIL:

Pi-Design AG, Kantonsstrasse 100, CH-6234 Triengen, Schweiz  
Gorrissen Federspiel Kierkegaard, H.C. Andersens Boulevard 12, 1553 København V, Danmark  
2007-05-11  
2012-05-11

(11) DR 2007 00249  
(21) DA 2007 00123

(54) En kaffekande med filter

(51)-Cl.07 01



(71) ANSØGER(E):  
(74) FULDMÆGTIG:  
(22) ANSØGNINGSDATO:  
(18) GYLDIG TIL:

Pi-Design AG, Kantonsstrasse 100, CH-6234 Triengen, Schweiz  
Gorrissen Federspiel Kierkegaard, H.C. Andersens Boulevard 12, 1553 København V, Danmark  
2007-05-14  
2012-05-14

(11) DR 2007 00250  
(21) DA 2007 00258

(54) En postkasse med lysindikator

(51)-Cl.25 03

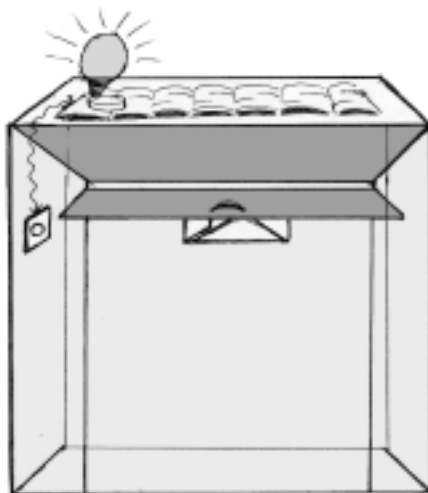

(71) ANSØGER(E):

Samer Al-Saadi, Havkærvej 61, 8381 Tilst, Danmark  
Raafat Nasser, Langkærvej 9, 2.th., 8381 Tilst, Danmark

(22) ANSØGNINGSDATO:

2007-11-04

(18) GYLDIG TIL:

2012-11-04

(11) DR 2007 00251

(54) 1) Et håndsæt 2) håndsæts tastaturknappområde  
3) håndsæts tastaturknapper

(51)-Cl.14 03

(21) DA 2007 00220

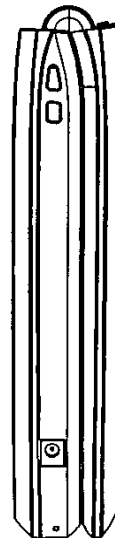
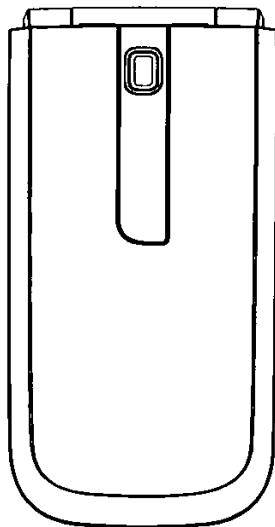
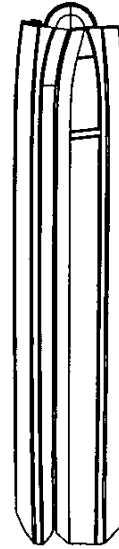
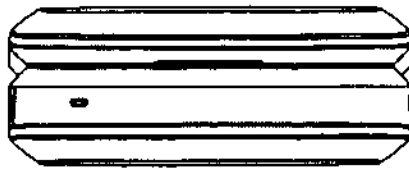

Løbenr. 1

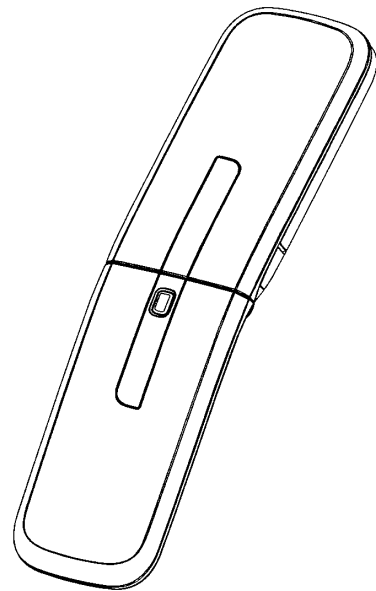
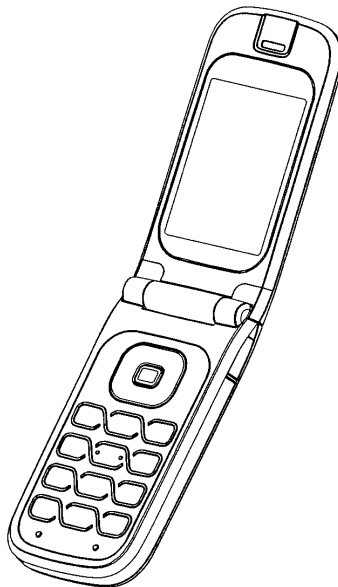
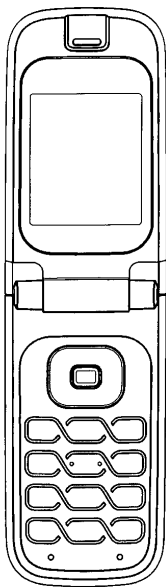
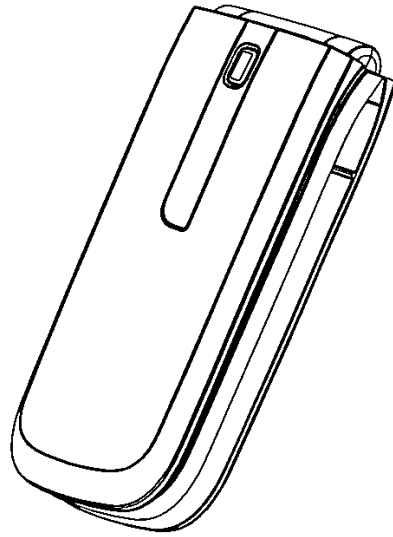
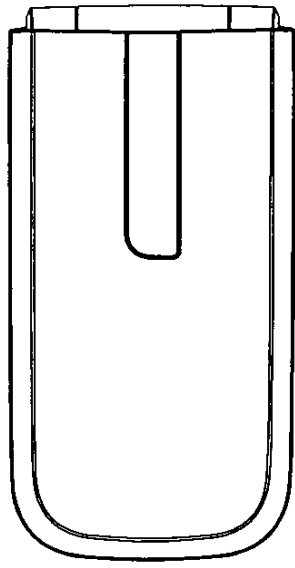

Løbenr. 1

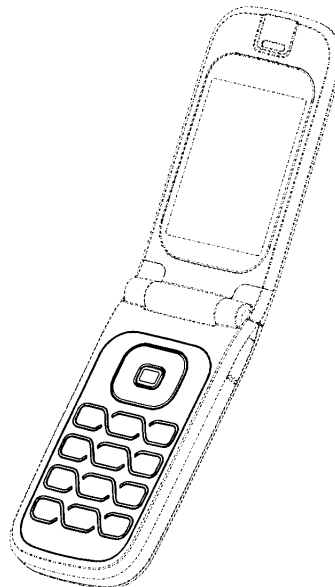
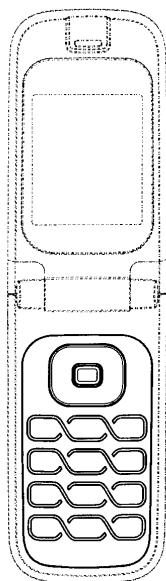

Løbenr. 2

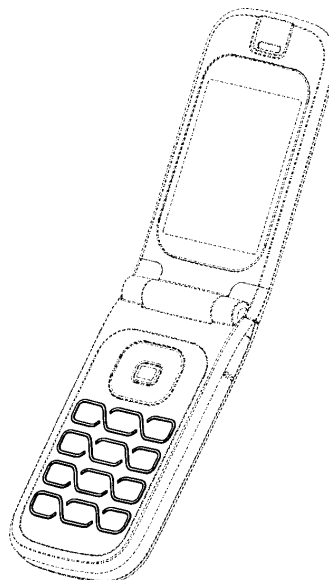
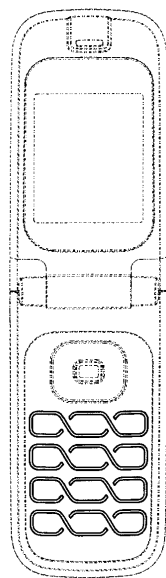

Løbenr. 3

(71) ANSØGER(E):  
(74) FULDMÆGTIG:  
(72) FREMBRINGER(E):  
(30) PRIORITET:  
(22) ANSØGNINGSDATO:  
(18) GYLDIG TIL:

Nokia Corporation, Keilalahdentie 4, FI-02150 Espoo, Finland  
Sandel, Løje & Wallberg, Frederiksgade 7, 1265 København K, Danmark  
Duncan Burns, #203 18645 Hatteras St., Tarzana, CA 91356, USA  
2007-03-30 US 29/278,485  
2007-09-14  
2012-09-14

(11) DR 2007 00252  
(21) DA 2007 00221

(54) 1) Et håndsæt 2) håndsæts tastaturknapper 3) håndsæt

(51)-Cl.14 03

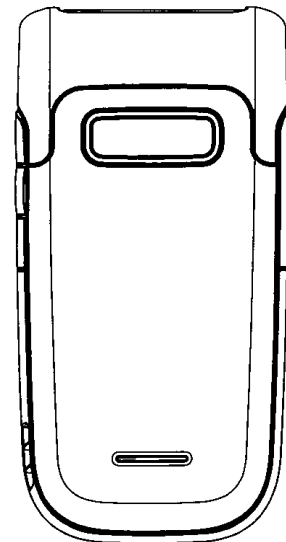
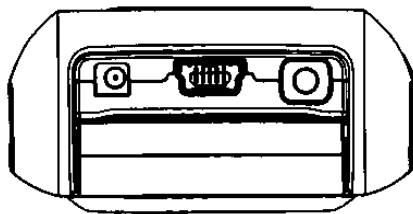
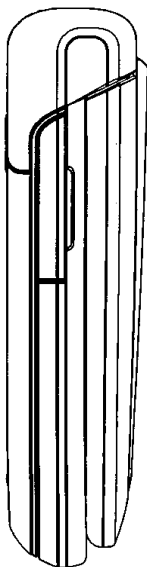
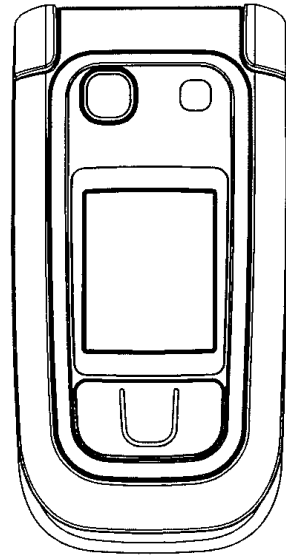
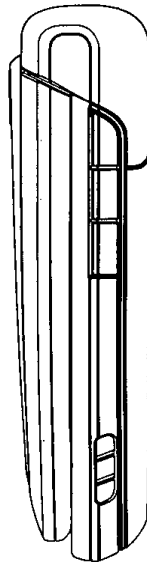
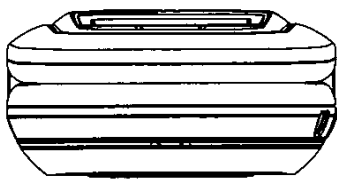

Løbenr. 1

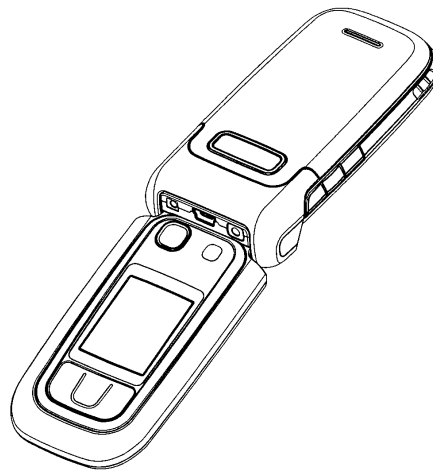
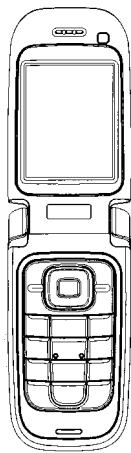
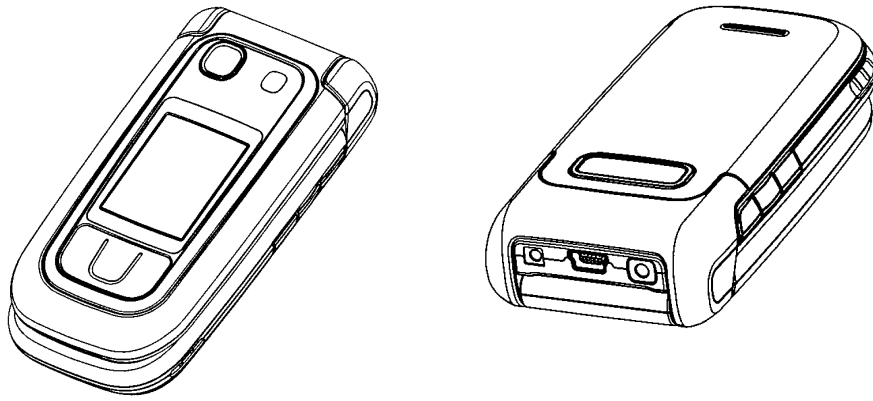

Løbenr. 1

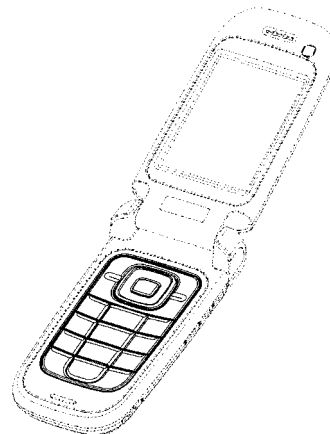
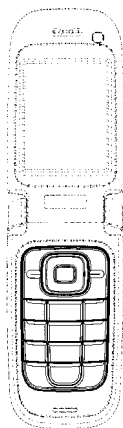

Løbenr. 2



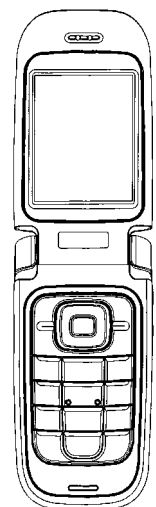
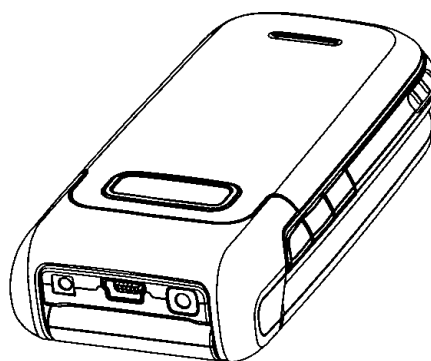
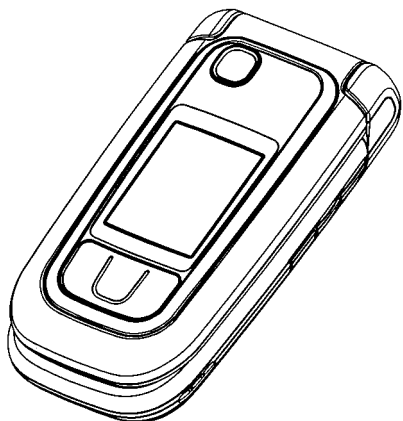
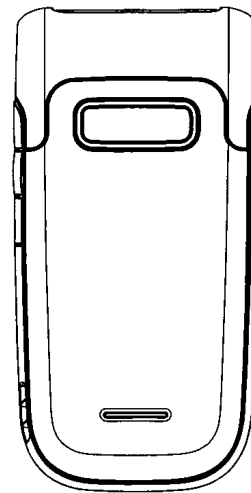
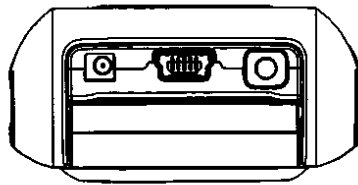
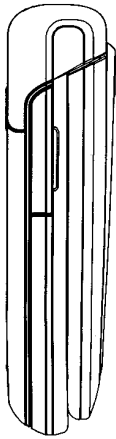
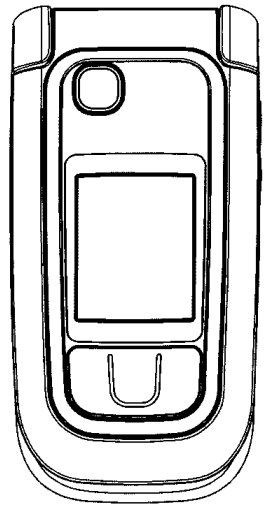
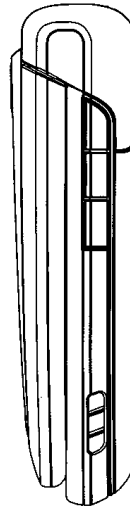
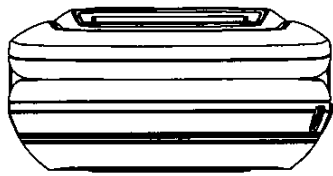

Løbenr. 3

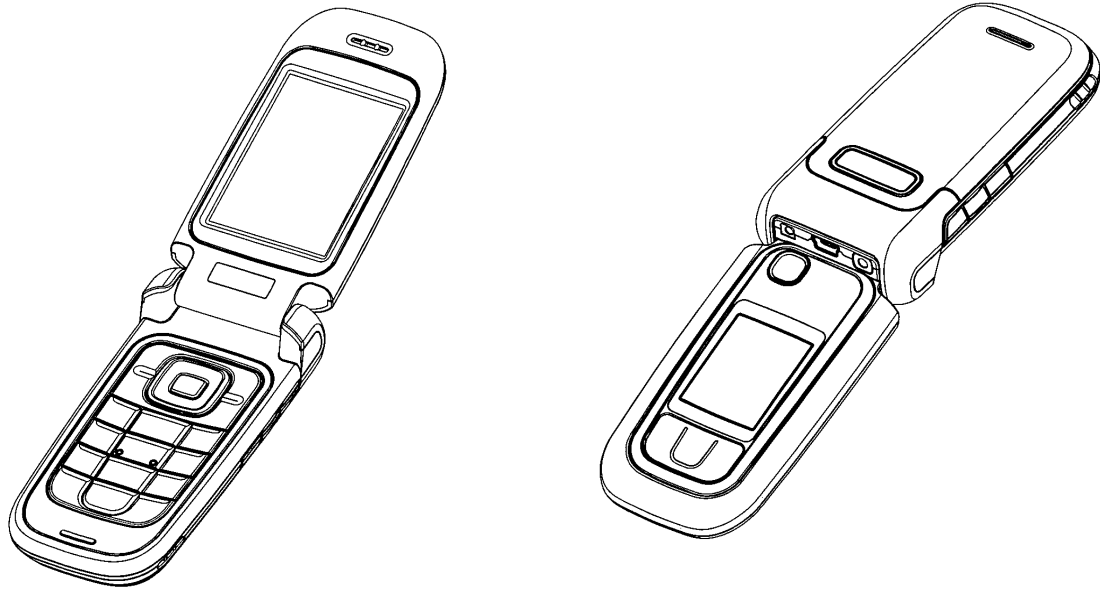

Løbenr. 3

(71) ANSØGER(E):	Nokia Corporation, Keilalahdentie 4, FI-02150 Espoo, Finland
(74) FULDMÆGTIG:	Sandel, Løje & Wallberg, Frederiksgade 7, 1265 København K, Danmark
(72) FREMBRINGER(E):	Edward D. Mitchell, 3267 Lanier Place, Thousand Oaks, Californien 91360, USA
(30) PRIORITET:	2007-03-23 US 29/278,284
(22) ANSØGNINGSDATO:	2007-09-14
(18) GYLDIG TIL:	2012-09-14

---

(11) DR 2007 00253  
(21) DA 2007 00235

(54) Et headset

(51)-Cl.14 01;14 03

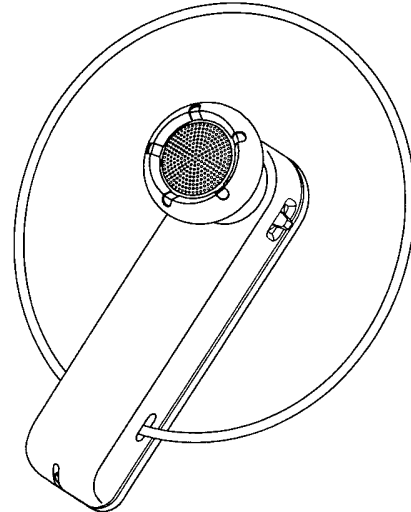
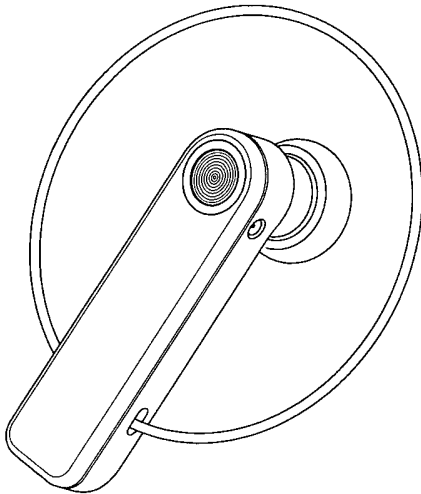
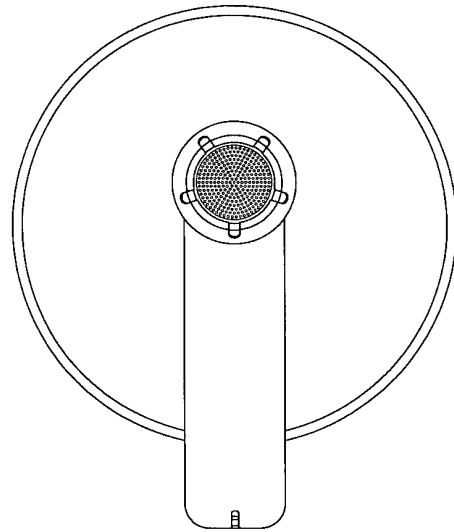
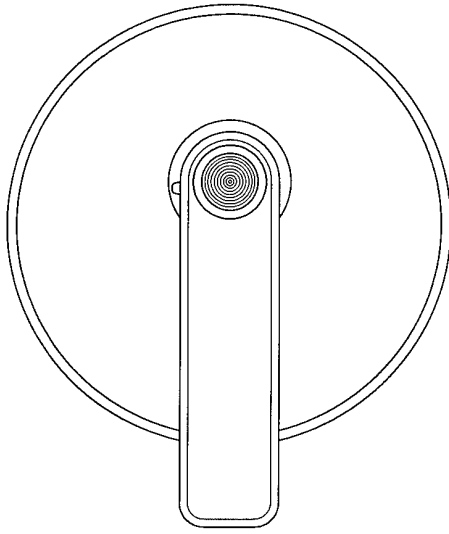

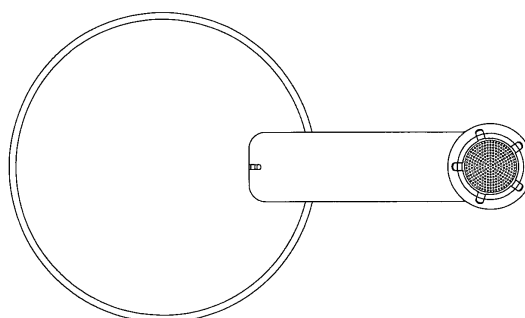
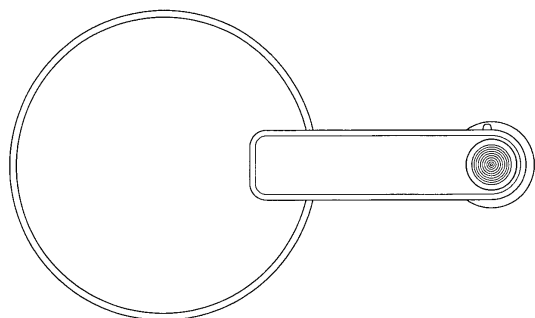
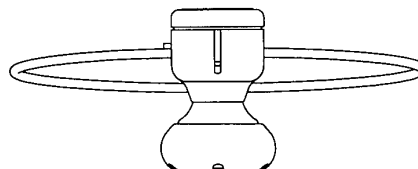
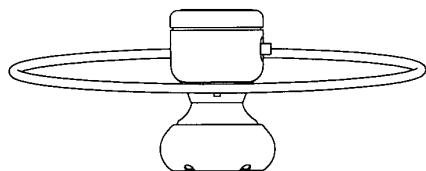
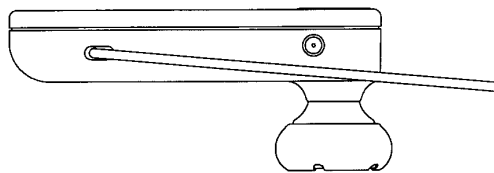
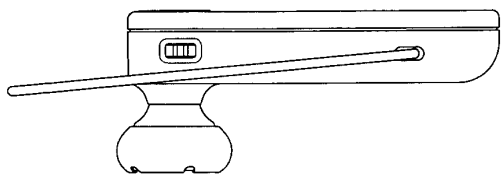

(71) ANSØGER(E):  
(74) FULDMÆGTIG:  
(72) FREMBRINGER(E):  
  
(30) PRIORITET:  
(22) ANSØGNINGSDATO:  
(18) GYLDIG TIL:

Nokia Corporation, Keilalahdentie 4, FI-02150 Espoo, Finland  
Sandel, Løje & Wallberg, Frederiksgade 7, 1265 København K, Danmark  
Heli Säde, Liitoskatu 11, FIN-24260 Salo, Finland  
Sami Lehtovaara, Suovasentie 52, FIN-21250 Masku, Finland  
2007-04-02 FI M20070062  
2007-09-27  
2012-09-27

(11) DR 2007 00254  
(21) DA 2007 00129

(54) 1) En istekande 2) isteglas

(51)-Cl.07 01



Løbenr. 1

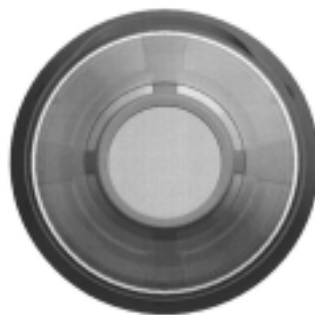
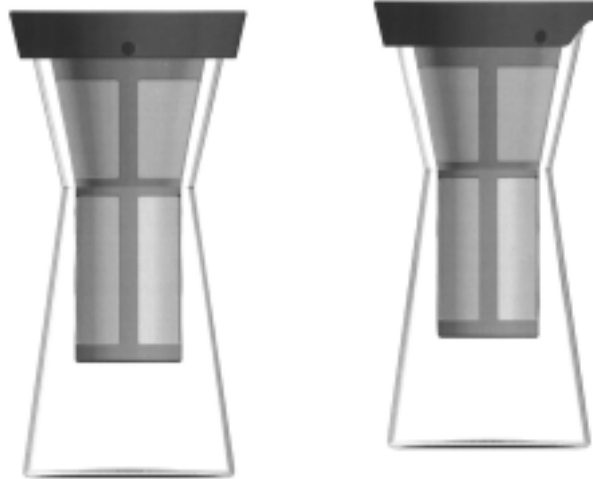

Løbenr. 2

(71) ANSØGER(E):  
(74) FULDMÆGTIG:  
(22) ANSØGNINGSDATO:  
(18) GYLDIG TIL:

Pi-Design AG, Kantonsstrasse 100, CH-6234 Triengen, Schweiz  
Gorrissen Federspiel Kierkegaard, H.C. Andersens Boulevard 12, 1553 København V, Danmark  
2007-05-21  
2012-05-21

(11) DR 2007 00255  
(21) DA 2007 00134

(54) 1-4) Stempelkrus

(51)-Cl.07 01;07 04

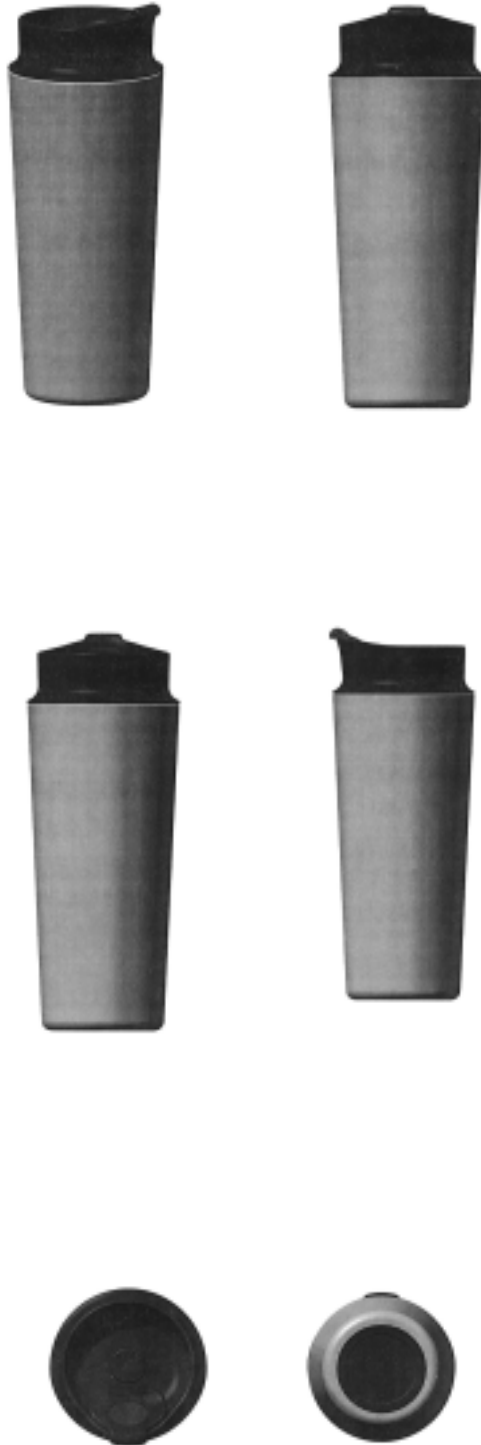

Løbenr. 1



Løbenr. 2



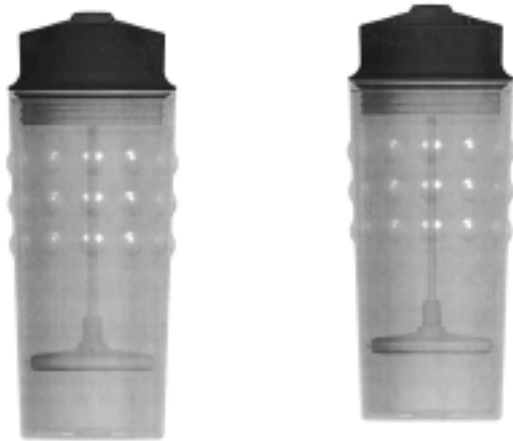

Løbenr. 3



Løbenr. 4

(71) ANSØGER(E):  
(74) FULDMÆGTIG:  
(22) ANSØGNINGSDATO:  
(18) GYLDIG TIL:

Pi-Design AG, Kantonsstrasse 100, CH-6234 Triengen, Schweiz  
Gorrissen Federspiel Kierkegaard, H.C. Andersens Boulevard 12, 1553 København V, Danmark  
2007-05-23  
2012-05-23

(11) DR 2007 00256  
(21) DA 2007 00133

(54) En stempelkande

(51)-Cl.07 04

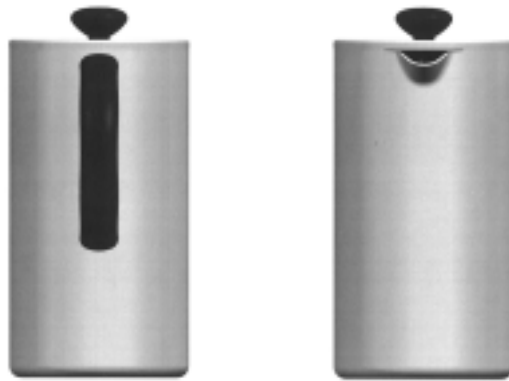

(71) ANSØGER(E):  
(74) FULDMÆGTIG:  
(22) ANSØGNINGSDATO:  
(18) GYLDIG TIL:

Pi-Design AG, Kantonsstrasse 100, CH-6234 Triengen, Schweiz  
Gorrissen Federspiel Kierkegaard, H.C. Andersens Boulevard 12, 1553 København V, Danmark  
2007-05-23  
2012-05-23

(11) DR 2007 00257  
(21) DA 2007 00261

(54) 1-2) Ornament

(51)-Cl.99 00

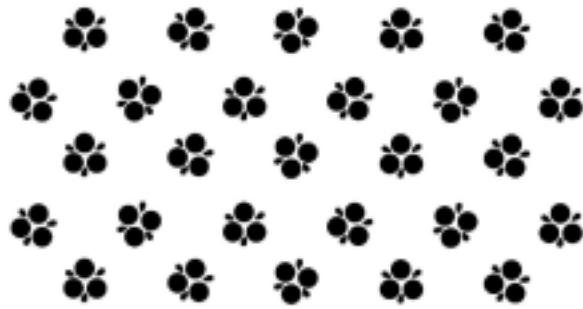

(71) ANSØGER(E): Frøken E Design I/S, Faksegade 8 A, 2100 København Ø, Danmark  
(74) FULDMÆGTIG: DANDERS & MORE Advokatfirma I/S, Lautrupsgade 7, 2100 København Ø, Danmark  
(22) ANSØGNINGSDATO: 2007-11-08  
(18) GYLDIG TIL: 2012-11-08  
(57) BEMÆRKNINGER: Ornament

## Offentligt tilgængelige designansøgninger og -registreringer

Akterne i nedenstående ansøgninger eller registreringer er tilgængelige for enhver, jf. § 21, stk. 2, i designlov nr. 1259 af 20. december 2000.

### Klasse 7

### Husholdningsartikler (ikke indeholdt i andre klasser)

(21) DA 2007 00118  
(71) ANSØGER(E):  
(22) ANSØGNINGSDATO:

(54) En istekande  
Pi-Design AG, Kantonsstrasse 100, CH-6234 Triengen, Schweiz  
2007-05-07

(21) DA 2007 00120  
(71) ANSØGER(E):  
(22) ANSØGNINGSDATO:

(54) 1-2) Dobbeltvægget glas  
Pi-Design AG, Kantonsstrasse 100, CH-6234 Triengen, Schweiz  
2007-05-08

(21) DA 2007 00122  
(71) ANSØGER(E):  
(22) ANSØGNINGSDATO:

(54) En kop  
Pi-Design AG, Kantonsstrasse 100, CH-6234 Triengen, Schweiz  
2007-05-11

(21) DA 2007 00123  
(71) ANSØGER(E):  
(22) ANSØGNINGSDATO:

(54) En kaffekande med filter  
Pi-Design AG, Kantonsstrasse 100, CH-6234 Triengen, Schweiz  
2007-05-14

(21) DA 2007 00129  
(71) ANSØGER(E):  
(22) ANSØGNINGSDATO:

(54) 1) En istekande 2) isteglas  
Pi-Design AG, Kantonsstrasse 100, CH-6234 Triengen, Schweiz  
2007-05-21

(21) DA 2007 00133  
(71) ANSØGER(E):  
(22) ANSØGNINGSDATO:

(54) En stempelkande  
Pi-Design AG, Kantonsstrasse 100, CH-6234 Triengen, Schweiz  
2007-05-23

(21) DA 2007 00134  
(71) ANSØGER(E):  
(22) ANSØGNINGSDATO:

(54) 1-4) Stempelkrus  
Pi-Design AG, Kantonsstrasse 100, CH-6234 Triengen, Schweiz  
2007-05-23

### Klasse 14

### Udstyr til optagelse og gengivelse af data, telekommunikationsudstyr

(21) DA 2007 00256  
(71) ANSØGER(E):  
(30) PRIORITET:  
(22) ANSØGNINGSDATO:

(54) Et håndsæt  
Nokia Corporation, Keilalahdentie 4, FI-02150 Espoo, Finland  
2007-05-11 FI M20070092  
2007-10-31

(21) DA 2007 00279  
(71) ANSØGER(E):  
(30) PRIORITET:  
(22) ANSØGNINGSDATO:

(54) En ledningsholder  
Nokia Corporation, Keilalahdentie 4, FI-02150 Espoo, Finland  
2007-05-25 FI M20070101  
2007-11-22

## Henlagte, afslåede eller tilbagetagne designansøgninger

Henlagte, afslåede eller tilbagetagne designansøgninger, som er offentligt tilgængelige.

(21) Ansøgningsnummer

(43) Offentliggjort i tidende

DA 2006 00291

DA 2007 00088

## Ændringer

Ændringer vedrørende retten til designet, indehaverens navn/firma og adresse, fuldmægtig m.v.

### Overdragelser:

(11) DR 2007 00237

Til: (71) SMARTTIE ApS, Dambakken 55, 2.th., 3460 Birkerød, Danmark

## Fornyelse af designregistreringer

Fornyelse af registreringer foretaget i medfør af § 23, stk. 1, i designlov nr. 1259 af 20. december 2000.

(11) Registreringsnummer	(18) Gyldig til
DR 2002 00772	20121106
DR 2002 00861	20121217
DR 2003 00263	20121112
DR 2002 00859	20121217
DR 2002 00345	20120601
DR 2002 00830	20121202
DR 2002 00856	20121213
DR 2002 00857	20121217
DR 2002 00858	20121217
DR 2003 00027	20121220
DR 2003 00260	20121111
DR 2003 00264	20121112
DR 2002 00386	20120513
DR 2003 00188	20121203
DR 2002 00851	20121212
DR 2002 00685	20121017
DR 2002 00716	20121024
DR 2002 00763	20120516
DR 2003 00069	20121118
DR 2003 00372	20130121
DR 2003 00373	20130122
DR 2003 00374	20130122
DR 2003 00296	20121120
DR 2003 00090	20121202
DR 2002 00570	20120822
DR 2003 00112	20121205



## Udslettede registreringer

Udslettede registreringer foretaget i medfør af designlov nr. 1259 af 20. december 2000.

(11) DR 2003 00067

(11) DR 2003 00253

(11) DR 2002 00824

Mønster

## Ændringer

Ændringer vedrørende retten til mønstret, mønsterhavers navn, bopæl, fulm. m.v.

### Ændring af fuldmægtigoplysninger:

(11) MR 1999 00601

Til: (74) Budde Schou A/S, Vester Søgade 10, 1601 København V, Danmark

## Fornyelse af mønsterregistreringer

Fornyelse af registreringer foretaget i medfør af lov om mønstre nr. 218 af 27. maj 1970.

(11) Registreringsnummer

(18) Gyldig til

MR 1998 00256  
MR 1999 00714  
MR 1998 00511  
MR 1998 00747  
MR 1998 00499

20120505  
20121219  
20121229  
20121125  
20121118

## Udslettelser af registreringer

Udslettelser af registreringer foretaget i medfør af lov om mønstre nr. 218 af 27. maj 1970.

(11) MR 1993 00638  
(11) MR 1993 00642  
(11) MR 1993 00643  
(11) MR 1993 00562  
(11) MR 1993 00650  
(11) MR 1993 00651  
(11) MR 1993 00747  
(11) MR 1993 00658  
(11) MR 1993 00835  
(11) MR 1993 00662  
(11) MR 1993 00748  
(11) MR 1993 00955  
(11) MR 1993 00672  
(11) MR 1994 00130  
(11) MR 1994 00131  
(11) MR 1993 00675  
(11) MR 1993 00789  
(11) MR 1993 00790  
(11) MR 1993 00791  
(11) MR 1993 00792  
(11) MR 1993 00793  
(11) MR 1993 00794  
(11) MR 1993 00677  
(11) MR 1993 00721  
(11) MR 1993 00722  
(11) MR 1993 00723  
(11) MR 1993 00724  
(11) MR 1997 00570  
(11) MR 1997 00976  
(11) MR 1997 00733  
(11) MR 1998 00009  
(11) MR 1998 00010  
(11) MR 1998 00012  
(11) MR 1998 00093  
(11) MR 1998 00342  
(11) MR 1998 00059  
(11) MR 1997 00790  
(11) MR 1997 00751  
(11) MR 1997 01055  
(11) MR 1998 00758

## Andre meddelelser

**Vi skal hermed gøre opmærksom på, at Patent- og Varemærkestyrelsen lukker kl. 12.00 den 14. december 2007.**

## WIPO Standard 80

# INID-koder

## Internationally agreed Numbers for the Identification of (bibliographic) data (INID)

- (11) Serial number of the registration
- (15) Date of the registration/Date of the renewal
- (17) Expected duration of the registration/  
renewal
- (18) Expected expiration date of the registration/  
renewal
- (21) Serial number of the application
- (22) Date of filing of the application
- (23) Name and place of exhibition, and date on  
which the industrial design was first  
exhibited there (Exhibition priority date)
- (24) Date from which the industrial design right  
has effect
- (29) Indication of the form in which the industrial  
design is filed, e.g. as a reproduction of the  
industrial design or as a specimen thereof
- (30) Data relating to priority under the Paris  
Convention
- (43) Date of publication of the industrial design  
before examination
- (44) Date of publication of the industrial design  
after examination but before registration
- (45) Date of publication of the registered  
industrial design
- (46) Date of expiration of deferment
- (51) International Classification for Industrial  
Designs (class and subclass of the Locarno  
Classification)
- (54) Designation of article(s) or product(s)  
covered by the industrial design or title of  
the industrial design
- (55) Reproduction of the industrial design (e.g.,  
drawing, photograph) and explanations  
relating to the reproduction
- (57) Description of characteristic features of the  
industrial design including indication of  
colors
- (58) Date of recording of any kind of  
amendment in the Register
- (62) Serial number(s) and, if available, filing  
date(s) of application(s), registration(s) or  
document(s) related by division
- (66) Serial number(s) of the application or the  
registration of the design(s), which is(are) a  
variant(s) of the present one
- (71) Name(s) and address(es) of the appli-  
cant(s)
- (72) Name(s) of the creator(s) if known to be  
such
- (73) Name(s) and address(es) of the owner(s)
- (74) Name(s) and address(es) of the  
representative(s)

## Domestic Codes for the Identification of Data

- (DL) Data concerning license
- (DP) Data concerning pawning

## Internationalt vedtagne Numre til Identifikation af Data (INID)

Registreringsnummer  
Registreringsdato/fornyelsesdato  
Forventet registreringsperiode/fornyelsesperiode  
Forventet udløbsdato for registrering/fornyelse

Ansøgningsnummer  
Ansøgningsdato  
Udstillingsnavn og -sted og dato for første udstil-  
ling (udstillingsprioritetsoplysninger)

Indleveringsdato

Angivelse af i hvilken form designet er indleveret,  
fx som en afbildning af designet eller som en  
model heraf  
Oplysninger om prioritet efter Pariserkonventionen

Dato for offentlig tilgængelighed

Bekendtgørelsesdato for ansøgningen

Offentliggørelse af registreringen

Udsættelsesdato  
International klassifikation af design (klasser og  
underklasser i Locarno Klassifikationen)

Vareangivelse/produktangivelse

Afbildninger af designet (fx tegninger, fotografier)  
og forklaringer vedrørende afbildningerne

Beskrivelse af karakteristiske træk vedr. designet,  
herunder angivelse af farver  
Dato for tilførsel til registret

Nummer på hovedansøgning eller udskilt ansøg-  
ning

Numre på beslægtede ansøgninger

Ansøgners navn og -adresse  
Frembringers/designers navn og adresse  
Indehavernavn og -adresse  
Fuldmægtignavn og -adresse

## Interne koder til identifikation af data

Licensoplysninger  
Pantoplysninger  
Oplysninger om konkurs