



PATENT- OG VAREMÆRKESTYRELSEN

Dansk Design- tidende

Indholdsfortegnelse

Designsager

| | |
|---|-----|
| Offentliggørelse af designregistreringer | 442 |
| Offentligt tilgængelige designansøgninger | 462 |
| Ændringer til design | 463 |
| Fornyelse af designregistreringer | 464 |
| Udslettelse af designregistreringer | 465 |

Mønstersager

| | |
|--|-----|
| Ændringer til mønstre | 467 |
| Fornyelse af mønsterregistreringer | 468 |
| Udslettelse af mønsterregistreringer | 469 |

Dansk Designtidende kan rekvireres som papirkopi for kr. 150 stk. på tlf. 43 50 85 35

Ansvarlig for redaktion: Keld Nymann Jensen
Udgives af Patent- og Varemærkestyrelsen, Helgeshøj Allé 81, 2630 Tåstrup, tlf. 43 50 80 00

ISSN 1601-7374

Design

Offentliggørelse af designregistreringer

Enhver kan anmode om hel- eller delvis udslettelse af en registrering (administrativ prøvning), jf. § 25 i designlov nr. 1259 af 20. december 2000. En model af designet kan ses i Patent- og Varemærkestyrelsen, hvis det er offentliggjort, at en model er indleveret til styrelsen. Det er anført, hvis et design er registreret i farve.

(11) DR 2007 00208
(21) DA 2007 00234

(54) En figur til bl.a. legeredskab og udstilling

(51)-Cl.11 02;21 01



(71) ANSØGER(E):
(22) ANSØGNINGSDATO:
(18) GYLDIG TIL:

Scanchemi Ingeniør & Handelsfirma v/Torben Henssel, Øverste Linievej 8, 4671 Strøby, Danmark
2007-09-24
2012-09-24

(11) DR 2007 00209
(21) DA 2007 00091

(54) En gaveæske til blomster

(51)-Cl.09 03



(71) ANSØGER(E):
(72) FREMBRINGER(E):
(22) ANSØGNINGSDATO:
(18) GYLDIG TIL:
(57) BEMÆRKNINGER

GARTNERIET GAMMELGÅRD ApS, Anderupvej 78, 5270 Odense N, Danmark
GARTNERIET GAMMELGÅRD ApS, Anderupvej 78, 5270 Odense N, Danmark
2007-04-18
2012-04-18
Farver

(11) DR 2007 00210
(21) DA 2007 00205

(54) En musikafspiller

(51)-Cl.14 01

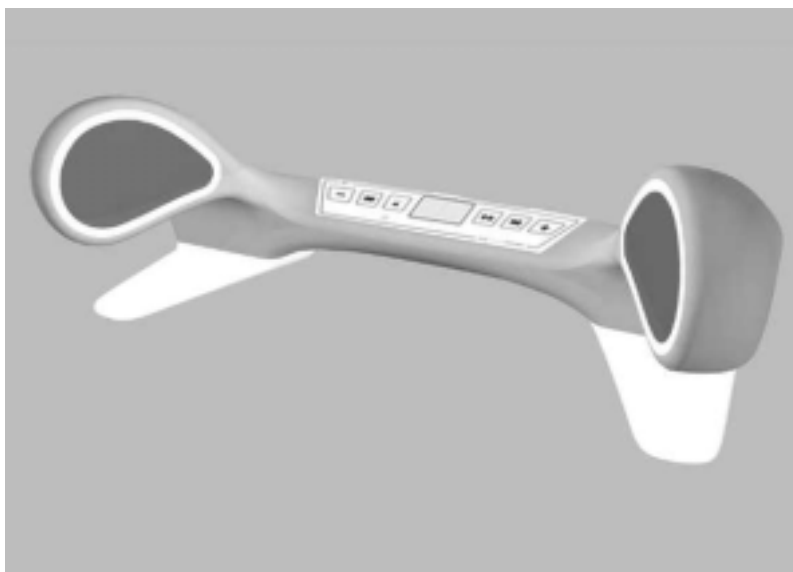

(71) ANSØGER(E):
(72) FREMBRINGER(E):
(22) ANSØGNINGSDATO:
(18) GYLDIG TIL:

Maysound ApS, Havnegade 30, 2-2, 7100 Vejle, Danmark
Jens Laulund Jensen, Christiansgade 39, 5000 Odense C, Danmark
2007-08-27
2012-08-27

(11) DR 2007 00211
(21) DA 2007 00213

(54) Et skrivebord der kan hæves og sænkes

(51)-Cl.06 03;20 02

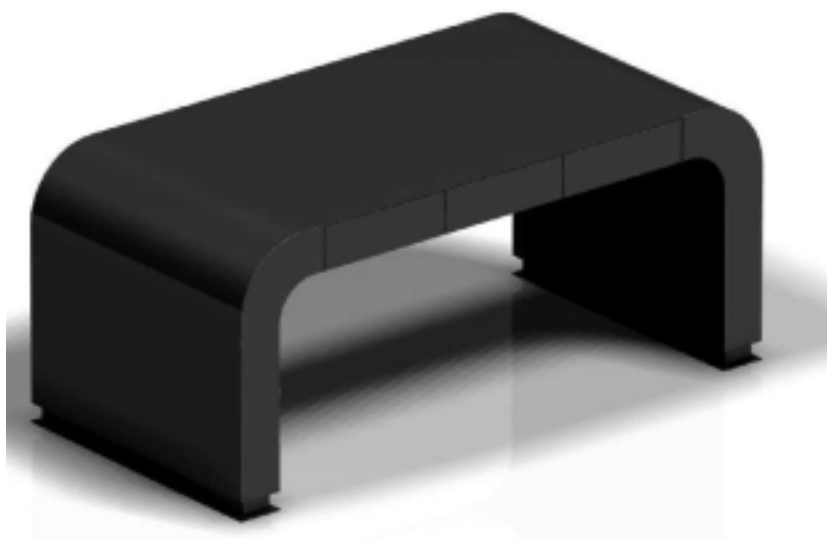

(71) ANSØGER(E):
(74) FULDMÆGTIG:
(72) FREMBRINGER(E):
(22) ANSØGNINGSDATO:
(18) GYLDIG TIL:

Signalement v/Peter Petersen, Norgesvej 51 U, 6100 Haderslev, Danmark
ADVOKATFIRMAET DAHL, KOCH & BOLL, ESBJERG A/S, Markedspladsen 25, 6800 Varde, Danmark
Peter Petersen, Norgesvej 51 U, 6100 Haderslev, Danmark
2007-09-06
2012-09-06

(11) DR 2007 00212
(21) DA 2007 00095

(54) En redekasse

(51)-Cl.30 06

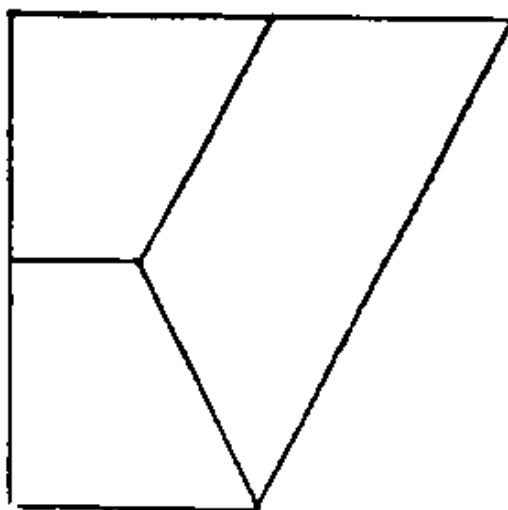
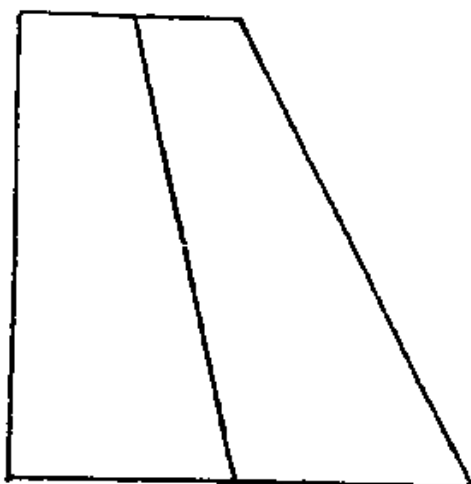
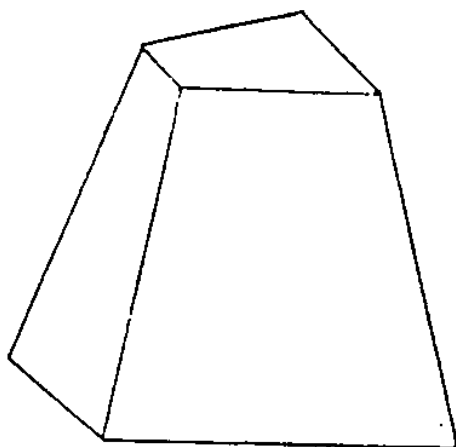

(71) ANSØGER(E):
(72) FREMBRINGER(E):
(22) ANSØGNINGSDATO:
(18) GYLDIG TIL:

Anders Tønner Jørgensen, Lillemarksvej 12, 4180 Sorø, Danmark
Anders Tønner Jørgensen, Lillemarksvej 12, 4180 Sorø, Danmark
2007-04-21
2012-04-21

(11) DR 2007 00213
(21) DA 2007 00147

(54) 1-2) Gavebånds dispenser med display

(51)-Cl.09 06;20 02

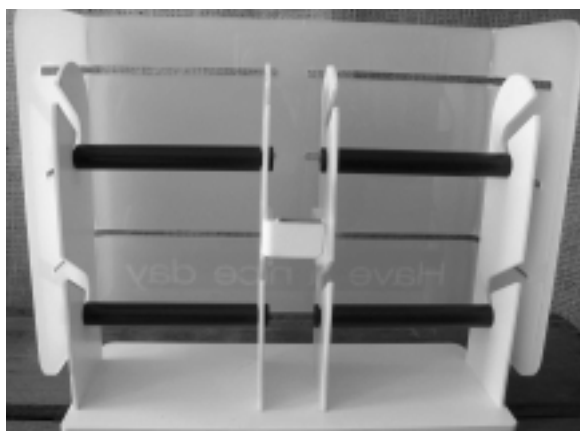

Løbenr. 1



Løbenr. 2

(71) ANSØGER(E):
(72) FREMBRINGER(E):
(22) ANSØGNINGSDATO:
(18) GYLDIG TIL:

VAGN BALSLEV ApS, Hørskæften 4, 2630 Taastrup, Danmark
Niels Kjeldsen Design, Vesterbrogade 74, 1620 København V, Danmark
2007-06-14
2012-06-14

(11) DR 2007 00214
(21) DA 2007 00101

(54) En lydmodtager

(51)-Cl.14 01



(71) ANSØGER(E):
(72) FREMBRINGER(E):
(22) ANSØGNINGSDATO:
(18) GYLDIG TIL:

Amplidan A/S, Lyngsø Alle 3, 2970 Hørsholm, Danmark
Mikael Sinding, Krøyersvej 22b, 2930 Klampenborg, Danmark
2007-04-25
2017-04-25

(11) DR 2007 00215
(21) DA 2007 00144

(54) En frontplade til stikkontakt

(51)-Cl.13 03

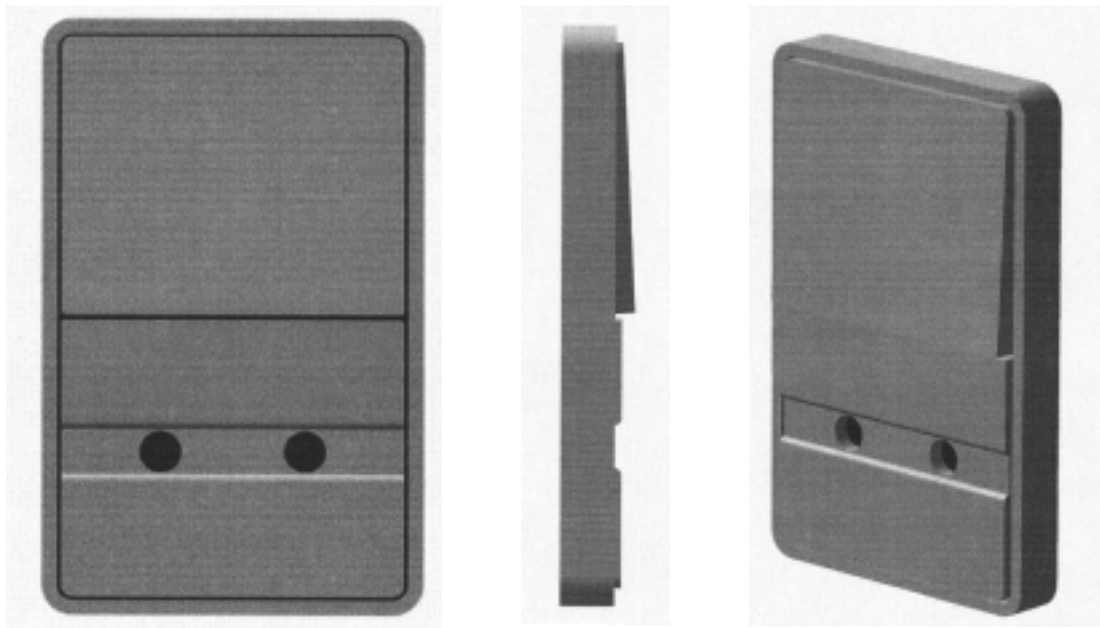

(71) ANSØGER(E):
(74) FULDMÆGTIG:
(22) ANSØGNINGSDATO:
(18) GYLDIG TIL:

JAN ERIK VEST HOLDING ApS, Hægh-Guldbergs Gade 111, 8000 Århus C, Danmark
Østjysk Innovation A/S, Forskerparken, Gustav Wiedes Vej 10, 8000 Århus C, Danmark
2007-06-12
2012-06-12

(11) DR 2007 00216

(54) 1) En mobiltelefon/MP3 afspiller med oplader 2) mobiltelefon/MP3 afspiller 3) oplader dertil
(51)-Cl.14 01;14 03

(21) DA 2007 00032

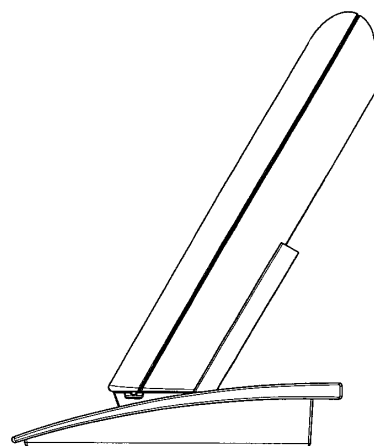
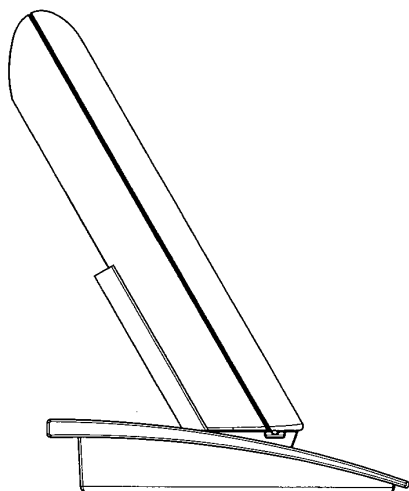
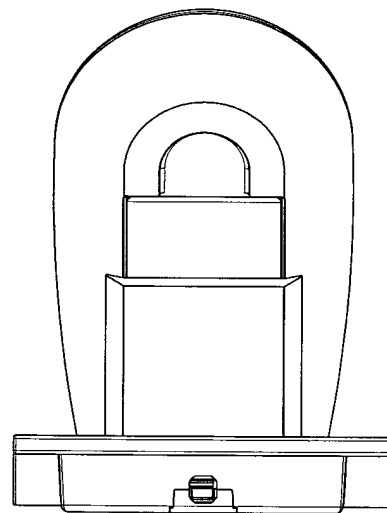
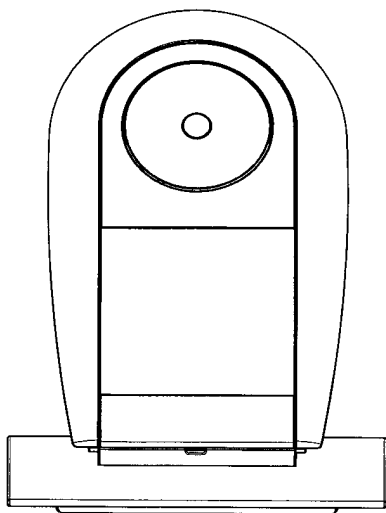
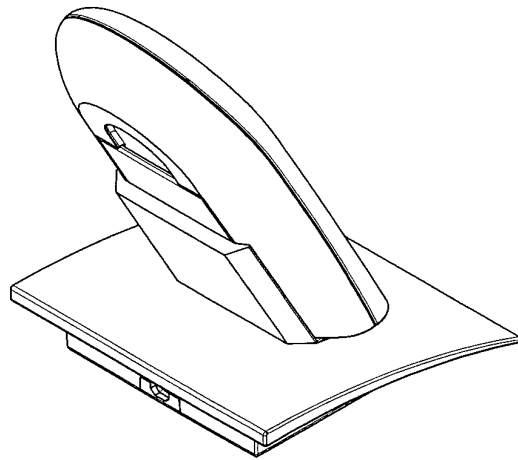
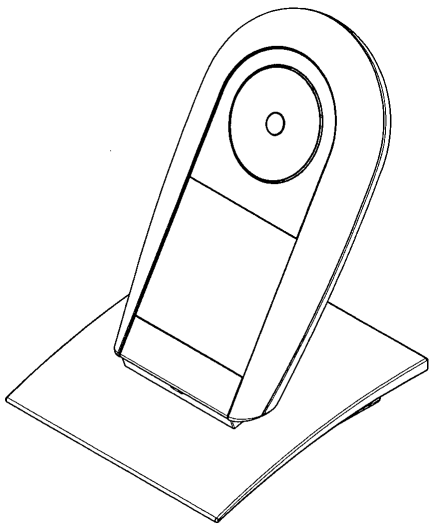

Løbenr. 1

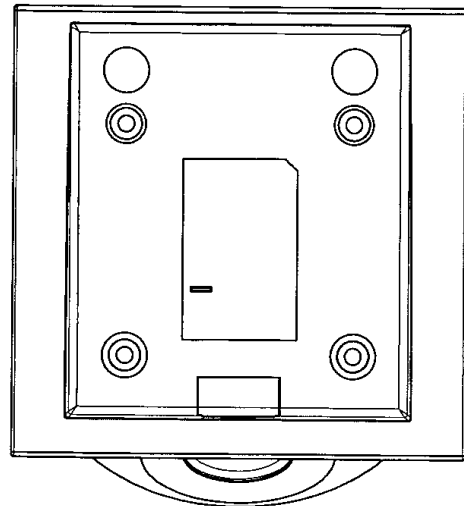
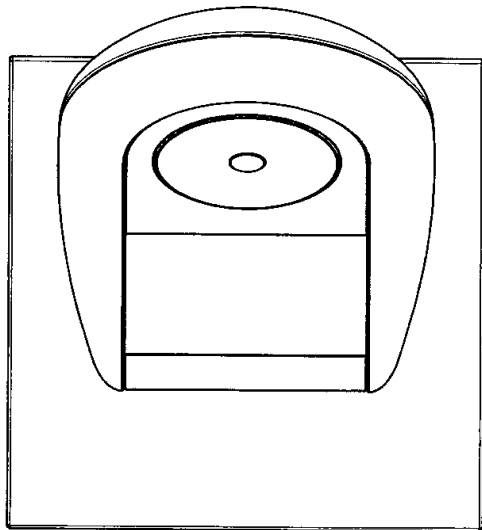

Løbenr. 1

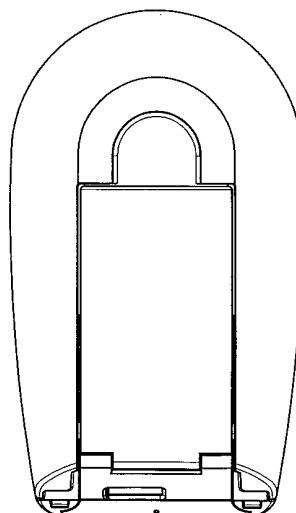
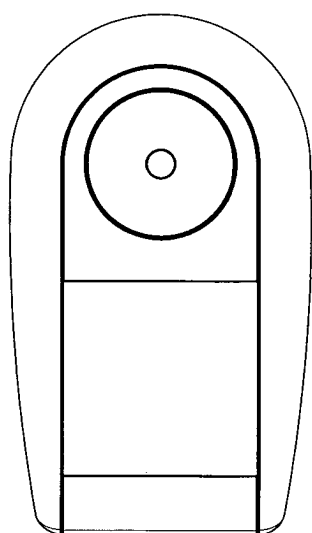
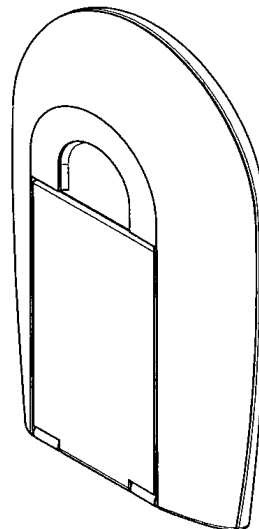
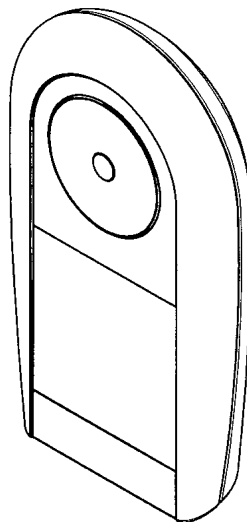

Løbenr. 2

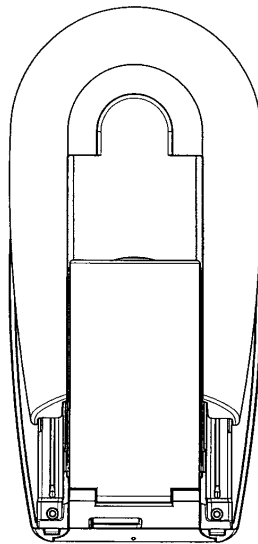
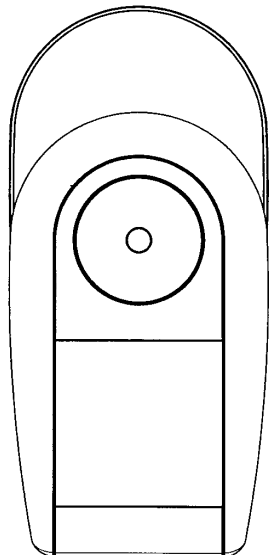
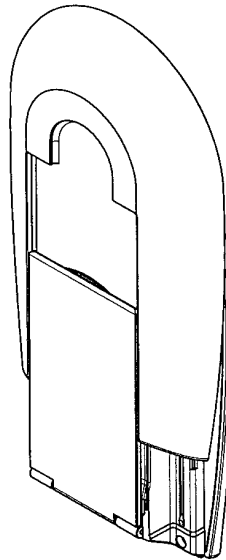
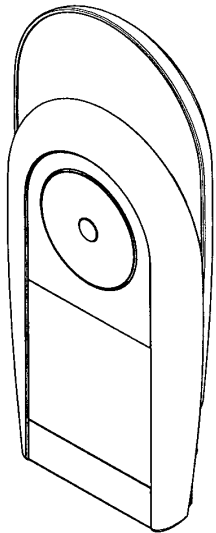
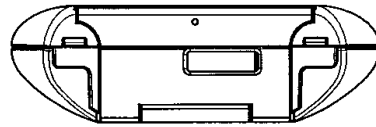
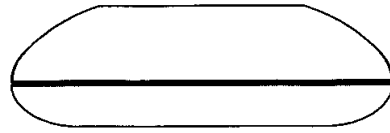
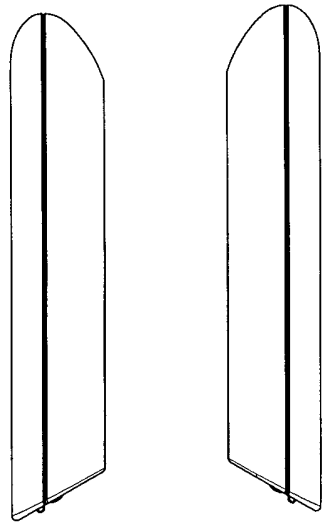

Løbenr. 2

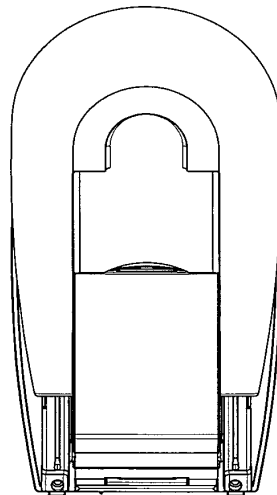
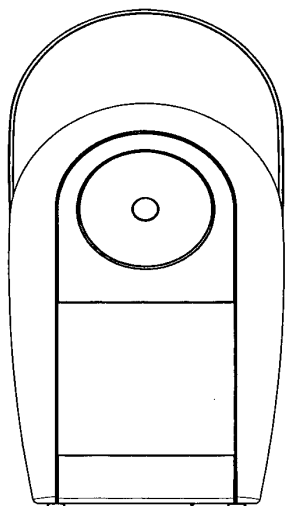
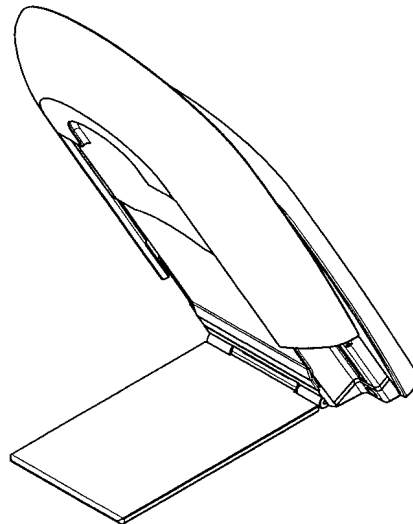
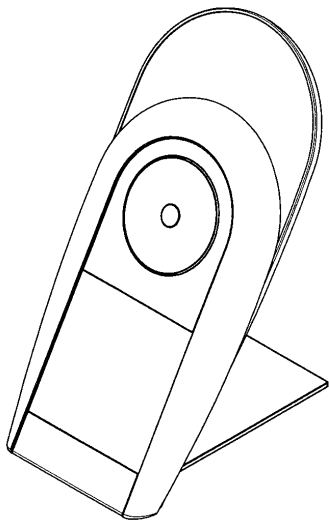
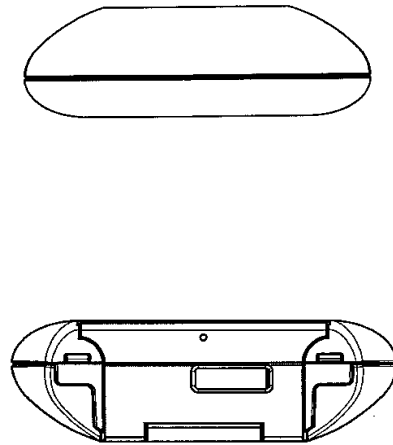
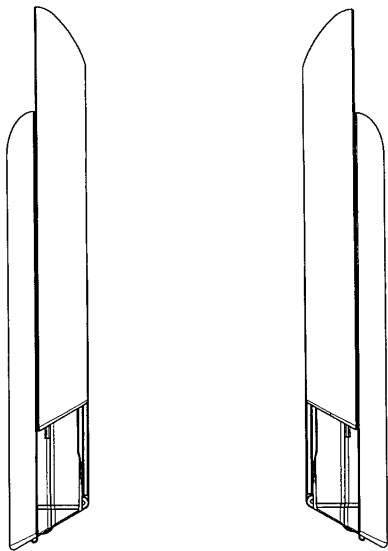

Løbenr. 2

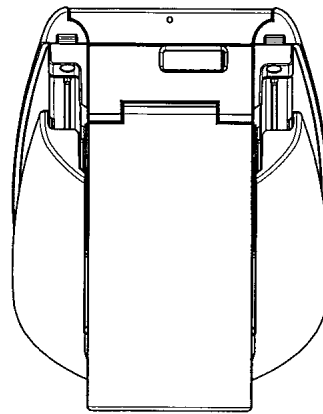
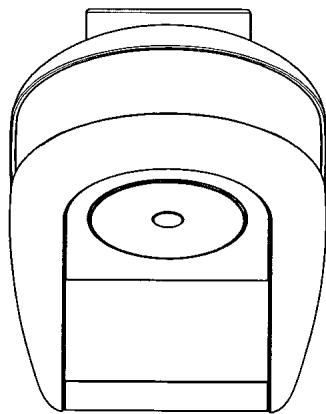
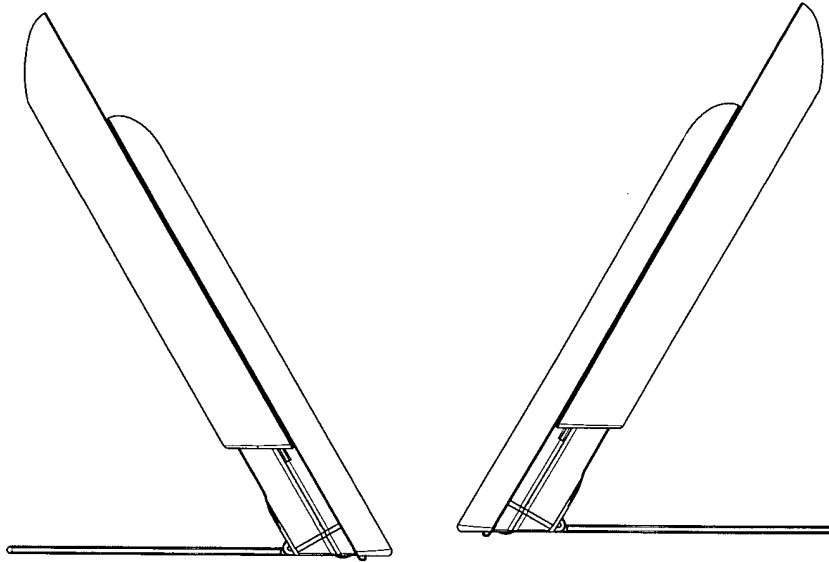

Løbenr. 2

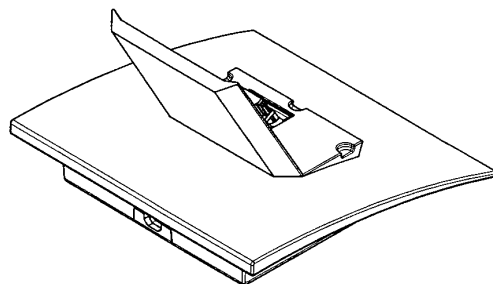
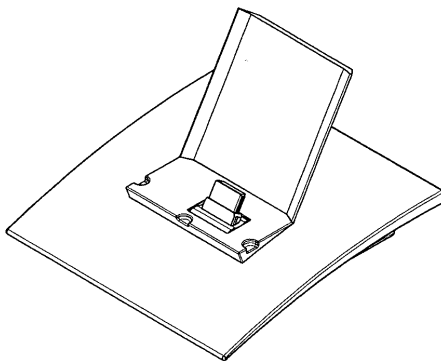

Løbenr. 3

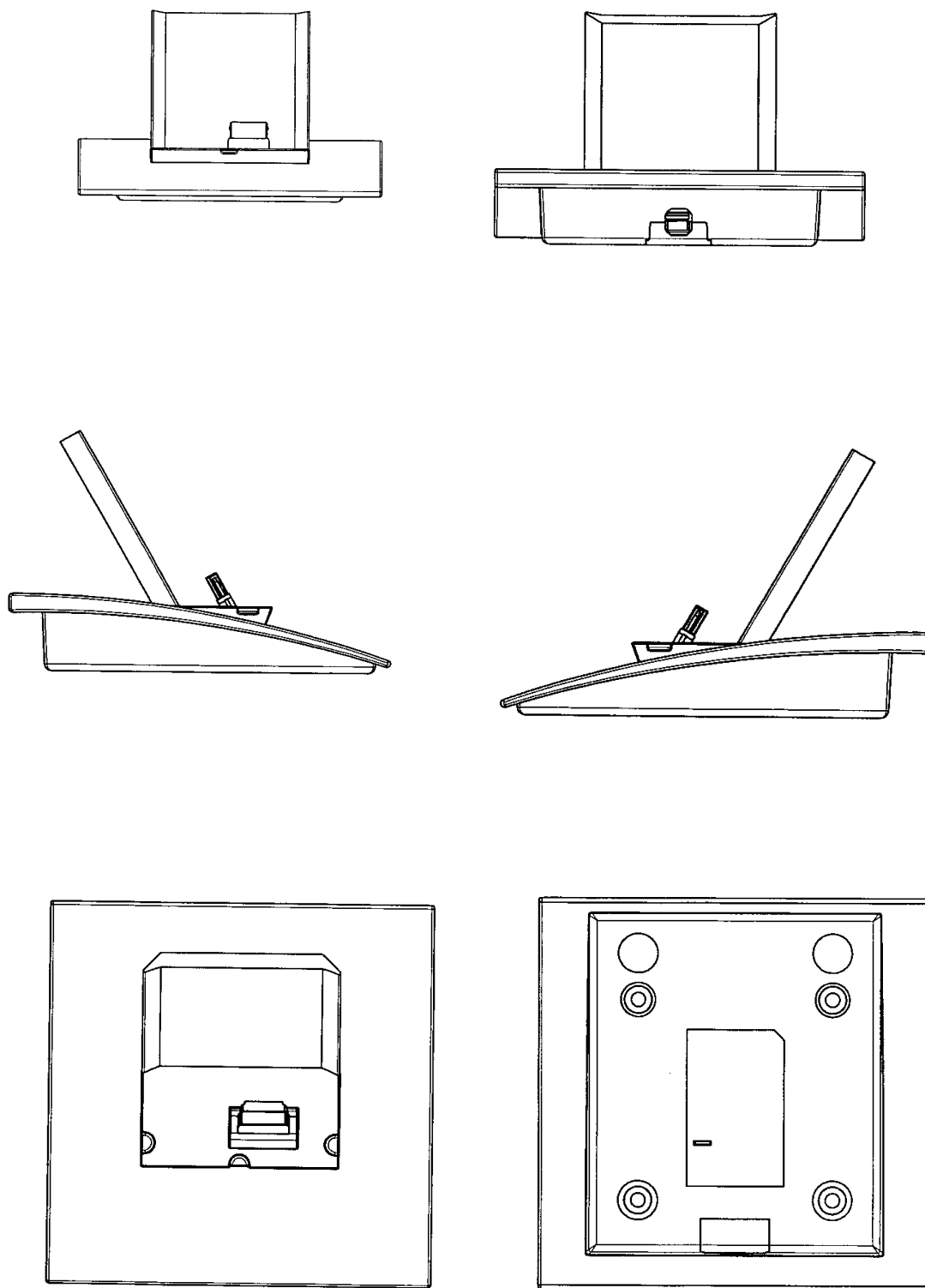

Løbenr. 3

(71) ANSØGER(E):
(74) FULDMÆGTIG:
(72) FREMBRINGER(E):
(22) ANSØGNINGSDATO:
(18) GYLDIG TIL:

Bang & Olufsen A/S, Peter Bangsvej 15, 7600 Struer, Danmark
Sandel, Løje & Wallberg, Frederiksgade 7, 1265 København K, Danmark
David Lewis, Blegdamsvej 28 D, 2200 København N, Danmark
2007-02-09
2012-02-09

(11) DR 2007 00217
(21) DA 2007 00188

(54) Et display

(51)-Cl.14 01;14 02;14 03

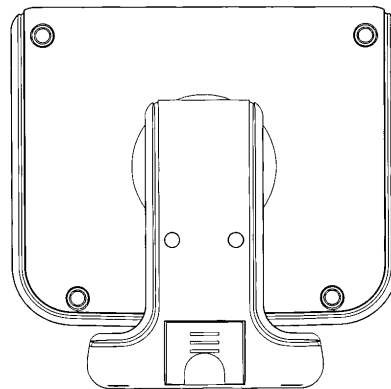
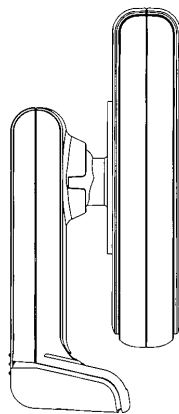
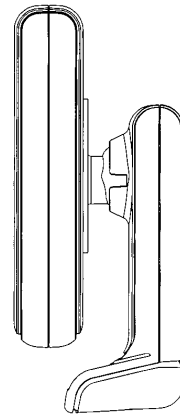
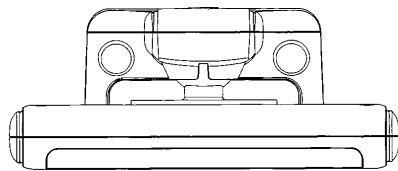
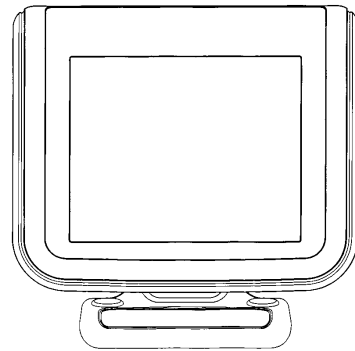
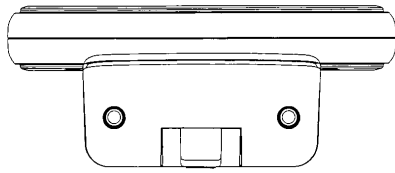

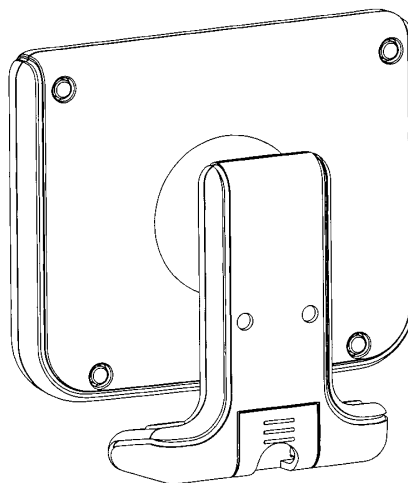
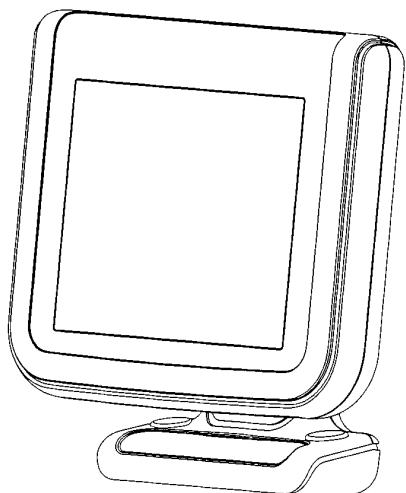

(71) ANSØGER(E): Nokia Corporation, Keilalahdentie 4, FI-02150 Espoo, Finland
(74) FULDMÆGTIG: Sandel, Løje & Wallberg, Frederiksgade 7, 1265 København K, Danmark
(72) FREMBRINGER(E): Sami Lehtovaara, Suovasentie 52, FIN-21250 Masku, Finland
(30) PRIORITET: 2007-02-09 FI M20070033
(22) ANSØGNINGSDATO: 2007-08-06
(18) GYLDIG TIL: 2012-08-06

(11) DR 2007 00218

(54) En bilholder - en mobiltelefonholder til et håndsæt eller en navigator

(51)-Cl.14 03;14 99

(21) DA 2007 00189

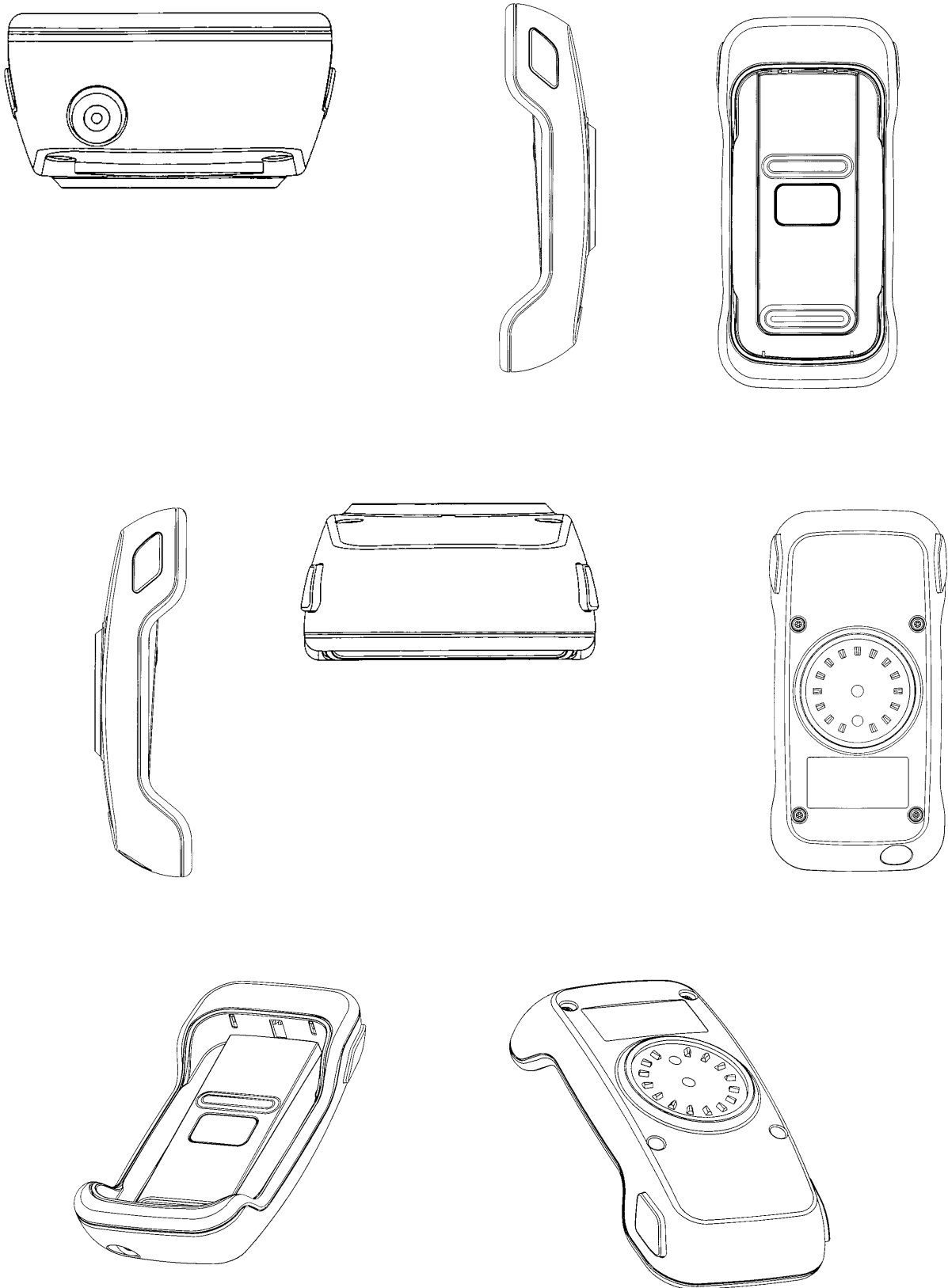

(71) ANSØGER(E):
 (74) FULDMÆGTIG:
 (72) FREMBRINGER(E):
 (30) PRIORITET:
 (22) ANSØGNINGSDATO:
 (18) GYLDIG TIL:

Nokia Corporation, Keilalahdentie 4, FI-02150 Espoo, Finland
 Sandel, Løje & Wallberg, Frederiksgade 7, 1265 København K, Danmark
 Jan Kettula, Leppävaarankatu 17 E 30, FIN-02600 Espoo, Finland
 2007-02-09 FI M20070033
 2007-08-06
 2012-08-06

(11) DR 2007 00219
(21) DA 2007 00190

(54) 1-2) Del af højttaler / musikanlæg

(51)-Cl.14 01;14 03;14 99

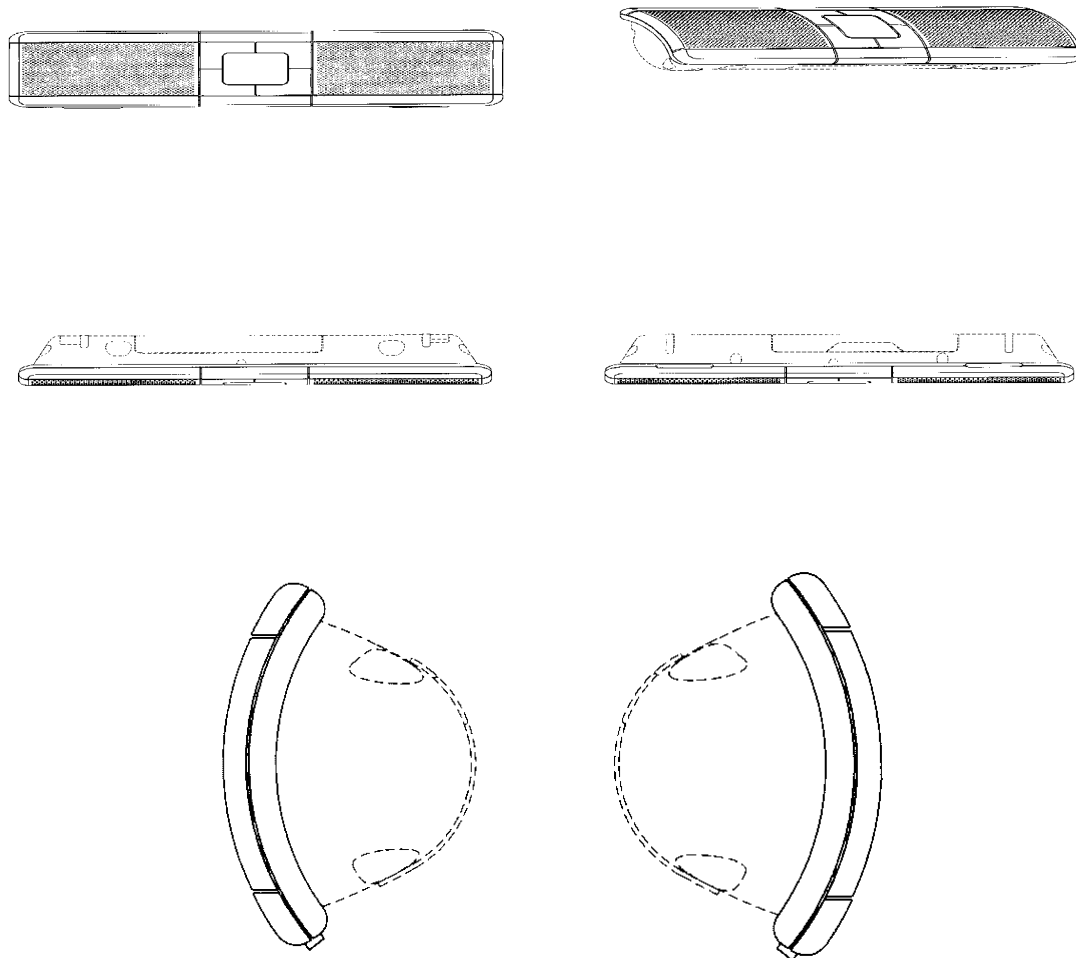

Løbenr. 1

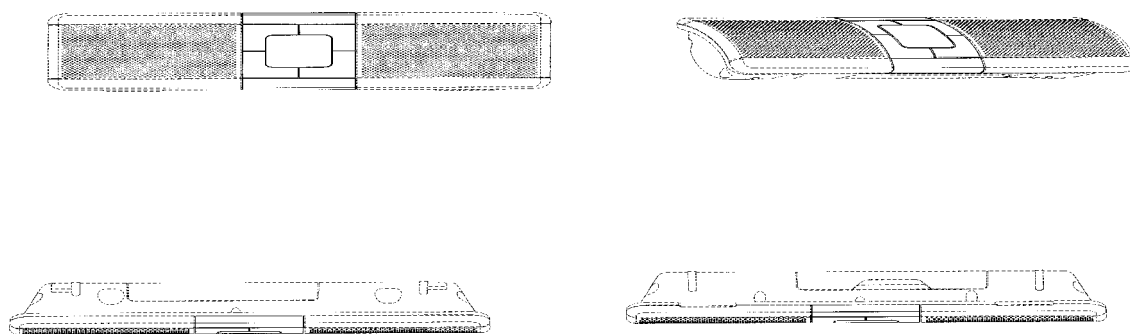

Løbenr. 2

(71) ANSØGER(E):
(74) FULDMÆGTIG:
(72) FREMBRINGER(E):
(30) PRIORITET:
(22) ANSØGNINGSDATO:
(18) GYLDIG TIL:

Nokia Corporation, Keilalahdentie 4, FI-02150 Espoo, Finland
Sandel, Løje & Wallberg, Frederiksgade 7, 1265 København K, Danmark
Alejandro Sanguinetti, c/o Nokia Corporation, Keilalahdentie 4, FI-02150 Espoo, Finland
2007-02-09 FI M20070033
2007-08-07
2012-08-07

(11) DR 2007 00220
(21) DA 2007 00191

(54) En emballageæske

(51)-Cl.09 03

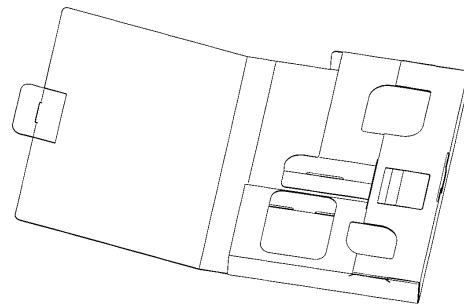
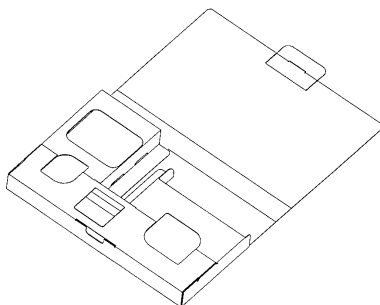
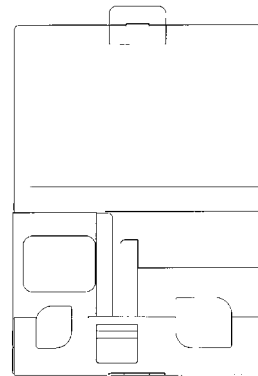
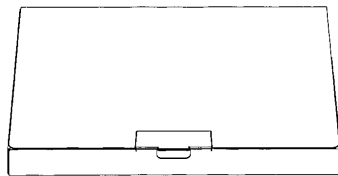
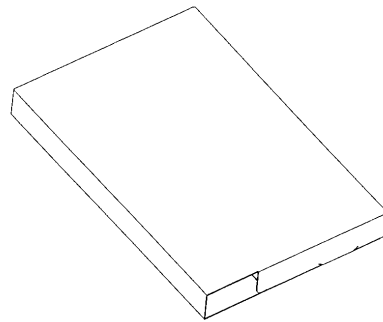
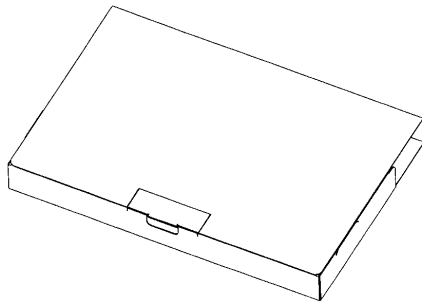
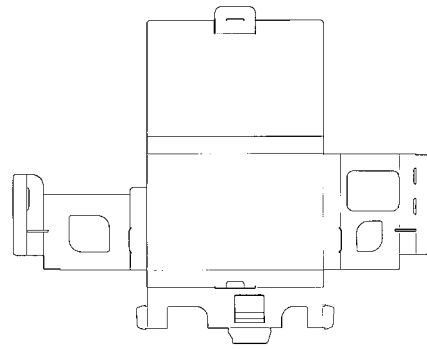
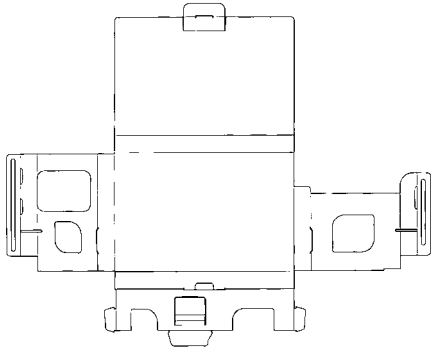

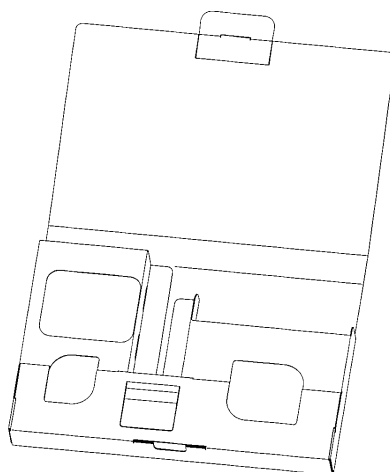

(71) ANSØGER(E): Nokia Corporation, Keilalahdentie 4, FI-02150 Espoo, Finland
(74) FULDMÆGTIG: Sandel, Løje & Wallberg, Frederiksgade 7, 1265 København K, Danmark
(72) FREMBRINGER(E): Mika Mattila, Sienestajankatu 7, FI-33580 Tampere, Finland
(30) PRIORITET: 2007-02-09 FI M20070032
(22) ANSØGNINGSDATO: 2007-08-08
(18) GYLDIG TIL: 2012-08-08

(11) DR 2007 00221
(21) DA 2007 00192

(54) 1) En label til batteri 2) batteri

(51)-Cl.13 02;19 08

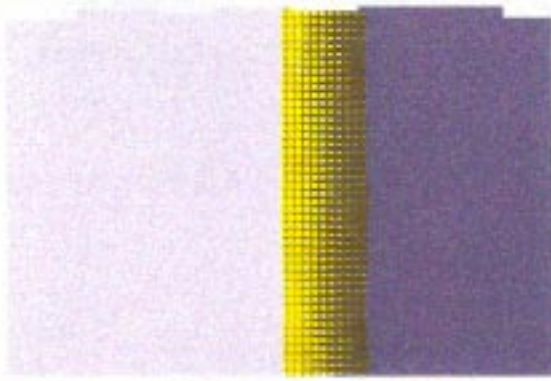

Løbenr. 1

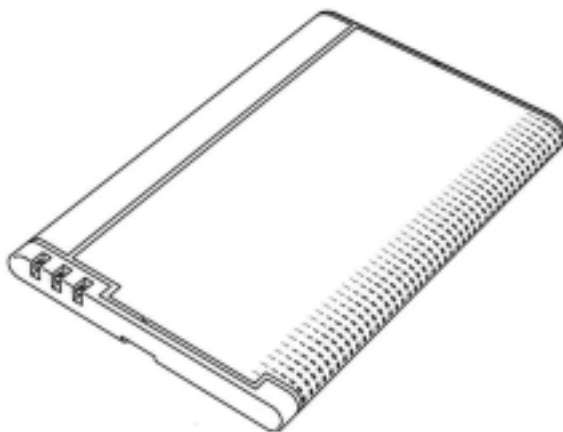
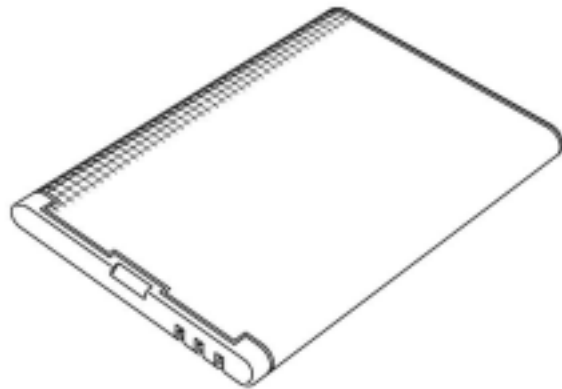
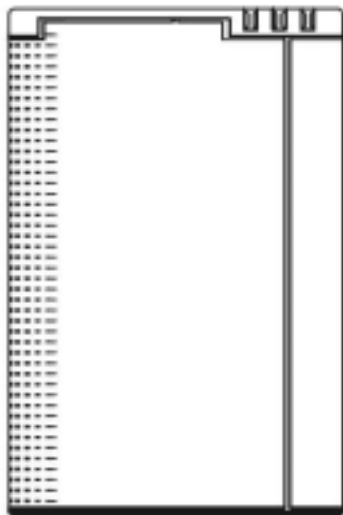
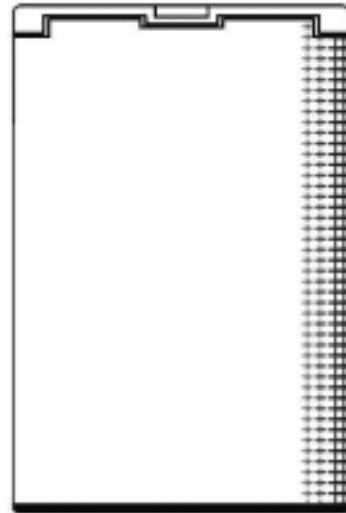

Løbenr. 2



Løbenr. 2

| | |
|----------------------|---|
| (71) ANSØGER(E): | Nokia Corporation, Keilalahdentie 4, FI-02150 Espoo, Finland |
| (74) FULDMÆGTIG: | Sandel, Løje & Wallberg, Frederiksgade 7, 1265 København K, Danmark |
| (72) FREMBRINGER(E): | Heli Säde, Liitoskatu 11, FI-24260 Salo, Finland |
| (30) PRIORITET: | 2007-02-09 FI M20070031 |
| (22) ANSØGNINGSDATO: | 2007-08-09 |
| (18) GYLDIG TIL: | 2012-08-09 |

(11) DR 2007 00222
(21) DA 2007 00185

(54) 1-2) En ramme til brønddæksel

(51)-Cl.25 02

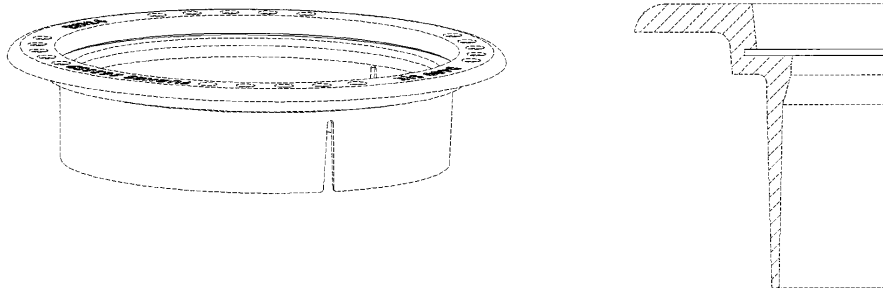

Løbenr. 1

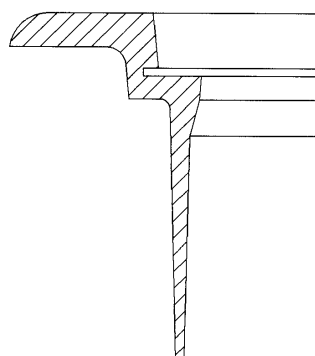

Løbenr. 2

(71) ANSØGER(E):
(74) FULDMÆGTIG:
(72) FREMBRINGER(E):
(30) PRIORITET:
(22) ANSØGNINGSDATO:
(18) GYLDIG TIL:

Furnes Hamjern SCC AS, NO-2335 Stange, Norge
Chas. Hude A/S, H.C. Andersens Boulevard 33, 1780 København V, Danmark
Johan G. Refsahl, N-2332 Åsvang, Norge
2007-02-01 NO 20070058; 2007-05-22 NO 20070466
2007-07-31
2012-07-31

Offentligt tilgængelige designansøgninger og -registreringer

Akterne i nedenstående ansøgninger eller registreringer er tilgængelige for enhver, jf. § 21, stk. 2, i designlov nr. 1259 af 20. december 2000.

Klasse 14

Udstyr til optagelse og gengivelse af data, telekommunikationsudstyr

(21) DA 2007 00220

(71) ANSØGER(E):

(30) PRIORITET:

(22) ANSØGNINGSDATO:

(54) 1) Et håndsæt 2) håndsæts tastaturknopområde 3) håndsæts tastaturknapper

Nokia Corporation, Keilalahdentie 4, FI-02150 Espoo, Finland

2007-03-30 US 29/278,485

2007-09-14

(21) DA 2007 00235

(71) ANSØGER(E):

(30) PRIORITET:

(22) ANSØGNINGSDATO:

(54) Et headset

Nokia Corporation, Keilalahdentie 4, FI-02150 Espoo, Finland

2007-04-02 FI M20070062

2007-09-27

Ændringer

Ændringer vedrørende retten til designet, indehaverens navn/firma og adresse, fuldmægtig m.v.

Overdragelser:

(11) DR 2006 00227

Til: (71) DONG Energy A/S, Nesa Alle 1, 2820 Gentofte, Danmark

Fornyelse af designregistreringer

Fornyelse af registreringer foretaget i medfør af § 23, stk. 1, i designlov nr. 1259 af 20. december 2000.

| (11) Registreringsnummer | (18) Gyldig til |
|--------------------------|-----------------|
| DR 2002 00777 | 20121023 |
| DR 2002 00665 | 20121008 |
| DR 2002 00666 | 20121008 |
| DR 2002 00773 | 20121008 |
| DR 2002 00655 | 20120927 |
| DR 2002 00845 | 20121120 |
| DR 2002 00865 | 20121122 |
| DR 2003 00210 | 20120930 |
| DR 2002 00745 | 20120926 |
| DR 2002 00846 | 20121008 |
| DR 2002 00687 | 20121018 |
| DR 2002 00680 | 20120930 |
| DR 2002 00735 | 20121029 |
| DR 2002 00708 | 20120611 |

Udslettede registreringer

Udslettede registreringer foretaget i medfør af designlov nr. 1259 af 20. december 2000.

(11) DR 2003 00215

Mønster

Ændringer

Ændringer vedrørende retten til mønstret, mønsterhavers navn, bopæl, fulm. m.v.

Overdragelser:

(11) MR 1997 00567

Til: (71) Steelform Scandinavia AB, Värendsgatan 30, S-360 30 Lammhult, Sverige

Fornyelse af mønsterregistreringer

Fornyelse af registreringer foretaget i medfør af lov om mønstre nr. 218 af 27. maj 1970.

| (11) Registreringsnummer | (18) Gyldig til |
|--------------------------|-----------------|
| MR 1998 00134 | 20120912 |
| MR 1998 00500 | 20121127 |
| MR 1998 00539 | 20121219 |
| MR 1998 00407 | 20120922 |
| MR 1998 00406 | 20120922 |
| MR 1998 00134 | 20120912 |
| MR 1998 00134 | 20120912 |
| MR 1998 00226 | 20121002 |
| MR 1998 00200 | 20121002 |
| MR 1998 00201 | 20121002 |
| MR 1998 00199 | 20121002 |
| MR 1998 00198 | 20121002 |
| MR 1998 00458 | 20121007 |
| MR 1998 00459 | 20121007 |
| MR 1998 00227 | 20121002 |
| MR 1998 00416 | 20121007 |
| MR 1998 00440 | 20121119 |
| MR 1998 00441 | 20121119 |
| MR 1998 00670 | 20121219 |

Udslettelser af registreringer

Udslettelser af registreringer foretaget i medfør af lov om mønstre nr. 218 af 27. maj 1970.

- (11) MR 1993 00552
- (11) MR 1993 01146
- (11) MR 1993 00833
- (11) MR 1993 00834
- (11) MR 1993 00559
- (11) MR 1993 00779
- (11) MR 1993 01084
- (11) MR 1993 00581
- (11) MR 1995 00803
- (11) MR 1993 00586
- (11) MR 1993 00589
- (11) MR 1993 00595
- (11) MR 1993 00604
- (11) MR 1993 00605
- (11) MR 1993 00899
- (11) MR 1993 00739
- (11) MR 1993 00610
- (11) MR 1993 00740
- (11) MR 1993 00627
- (11) MR 1993 00628
- (11) MR 1994 00055
- (11) MR 1993 00633
- (11) MR 1993 01091
- (11) MR 1997 00847
- (11) MR 1997 01046
- (11) MR 1997 00599
- (11) MR 1997 00600
- (11) MR 1997 00943
- (11) MR 1998 00047
- (11) MR 1997 01049
- (11) MR 1998 00308

WIPO Standard 80

INID-koder

Internationally agreed Numbers for the Identification of (bibliographic) data (INID)

- (11) Serial number of the registration
- (15) Date of the registration/Date of the renewal
- (17) Expected duration of the registration/
renewal
- (18) Expected expiration date of the registration/
renewal
- (21) Serial number of the application
- (22) Date of filing of the application
- (23) Name and place of exhibition, and date on
which the industrial design was first
exhibited there (Exhibition priority date)
- (24) Date from which the industrial design right
has effect
- (29) Indication of the form in which the industrial
design is filed, e.g. as a reproduction of the
industrial design or as a specimen thereof
- (30) Data relating to priority under the Paris
Convention
- (43) Date of publication of the industrial design
before examination
- (44) Date of publication of the industrial design
after examination but before registration
- (45) Date of publication of the registered
industrial design
- (46) Date of expiration of deferment
- (51) International Classification for Industrial
Designs (class and subclass of the Locarno
Classification)
- (54) Designation of article(s) or product(s)
covered by the industrial design or title of
the industrial design
- (55) Reproduction of the industrial design (e.g.,
drawing, photograph) and explanations
relating to the reproduction
- (57) Description of characteristic features of the
industrial design including indication of
colors
- (58) Date of recording of any kind of
amendment in the Register
- (62) Serial number(s) and, if available, filing
date(s) of application(s), registration(s) or
document(s) related by division
- (66) Serial number(s) of the application or the
registration of the design(s), which is(are) a
variant(s) of the present one
- (71) Name(s) and address(es) of the appli-
cant(s)
- (72) Name(s) of the creator(s) if known to be
such
- (73) Name(s) and address(es) of the owner(s)
- (74) Name(s) and address(es) of the
representative(s)

Domestic Codes for the Identification of Data

- (DL) Data concerning license
- (DP) Data concerning pawning

Internationalt vedtagne Numre til Identifikation af Data (INID)

Registreringsnummer
Registreringsdato/fornyelsesdato
Forventet registreringsperiode/fornyelsesperiode
Forventet udløbsdato for registrering/fornyelse

Ansøgningsnummer
Ansøgningsdato
Udstillingsnavn og -sted og dato for første udstil-
ling (udstillingsprioritetsoplysninger)

Indleveringsdato

Angivelse af i hvilken form designet er indleveret,
fx som en afbildning af designet eller som en
model heraf
Oplysninger om prioritet efter Pariserkonventionen

Dato for offentlig tilgængelighed

Bekendtgørelsesdato for ansøgningen

Offentliggørelse af registreringen

Udsættelsesdato
International klassifikation af design (klasser og
underklasser i Locarno Klassifikationen)

Vareangivelse/produktangivelse

Afbildninger af designet (fx tegninger, fotografier)
og forklaringer vedrørende afbildningerne

Beskrivelse af karakteristiske træk vedr. designet,
herunder angivelse af farver
Dato for tilførsel til registret

Nummer på hovedansøgning eller udskilt ansøg-
ning

Numre på beslægtede ansøgninger

Ansøgners navn og -adresse
Frembringers/designers navn og adresse
Indehavernavn og -adresse
Fuldmægtignavn og -adresse

Interne koder til identifikation af data

Licensoplysninger
Pantoplysninger
Oplysninger om konkurs