



PATENT- OG VAREMÆRKESTYRELSEN

Dansk Design- tidende

Indholdsfortegnelse

Designsager

Offentliggørelse af designregistreringer	393
Ændringer til design	411
Fornyelse af designregistreringer	412
Udslettelse af designregistreringer	413

Mønstersager

Ændringer til mønstre	415
Fornyelse af mønsterregistreringer	416
Udslettelse af mønsterregistreringer	417

Dansk Designtidende kan rekvireres som papirkopi for kr. 150 stk. på tlf. 43 50 85 35

Ansvarlig for redaktion: Keld Nymann Jensen
Udgives af Patent- og Varemærkestyrelsen, Helgeshøj Allé 81, 2630 Tåstrup, tlf. 43 50 80 00

ISSN 1601-7374

Design

Offentliggørelse af designregistreringer

Enhver kan anmode om hel- eller delvis udslettelse af en registrering (administrativ prøvning), jf. § 25 i designlov nr. 1259 af 20. december 2000. En model af designet kan ses i Patent- og Varemærkestyrelsen, hvis det er offentliggjort, at en model er indleveret til styrelsen. Det er anført, hvis et design er registreret i farve.

(11) DR 2006 00210
(21) DA 2006 00004

(54) Et fjernsyn

(51)-Cl.14 03

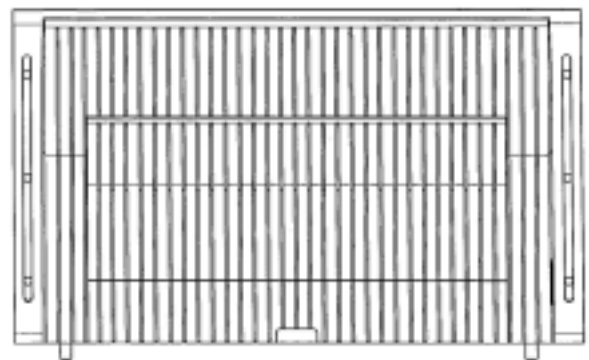
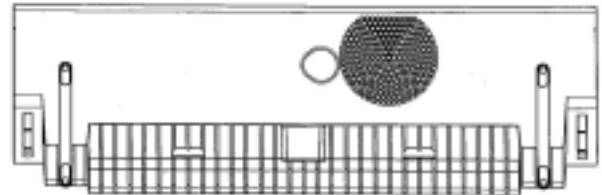
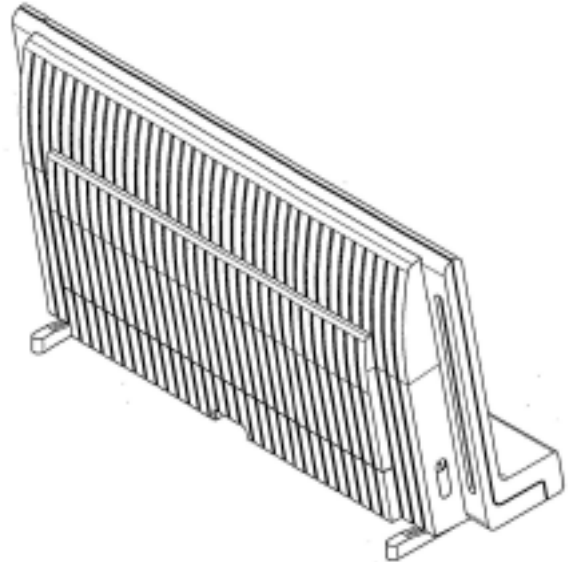
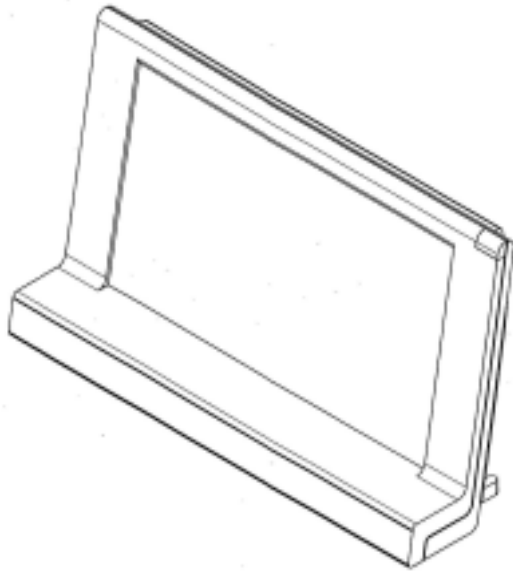



(71) ANSØGER(E): Bang & Olufsen A/S, Peter Bangsvej 15, 7600 Struer, Danmark
(74) FULDMÆGTIG: Sandel, Løje & Wallberg, Frederiksgade 7, 1265 København K, Danmark
(72) FREMBRINGER(E): David Lewis, Store Kongensgade 110 C, 1264 København K, Danmark
(22) ANSØGNINGSDATO: 2006-01-05
(18) GYLDIG TIL: 2011-01-05

(11) DR 2006 00211
(21) DA 2006 00037

(54) Et fjernsyn

(51)-Cl.14 03

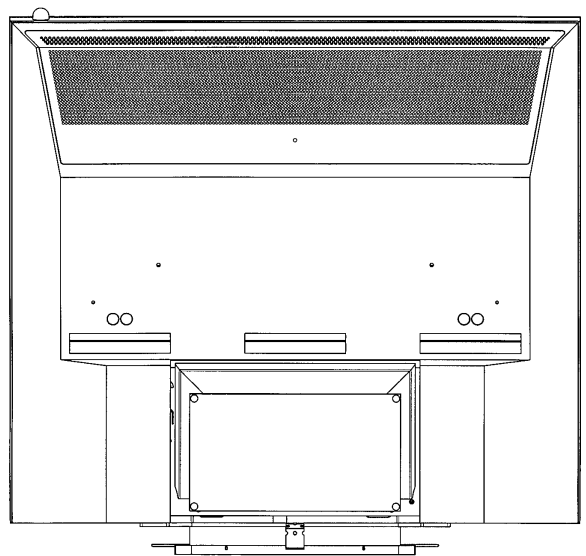
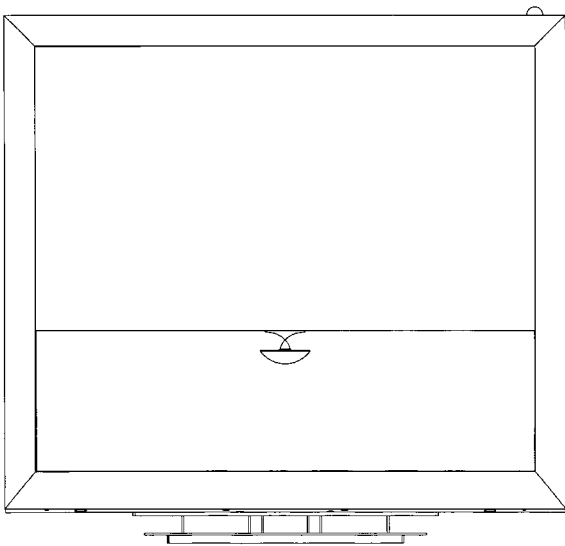
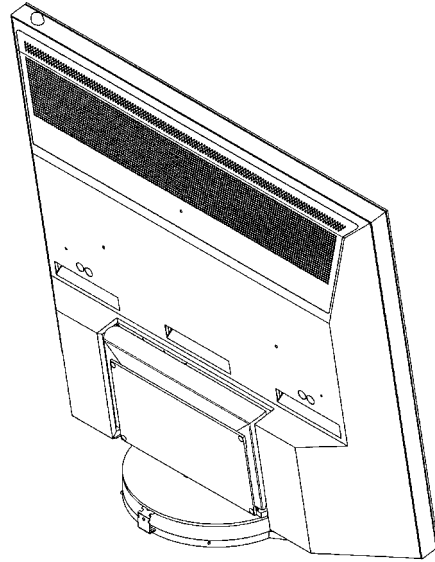
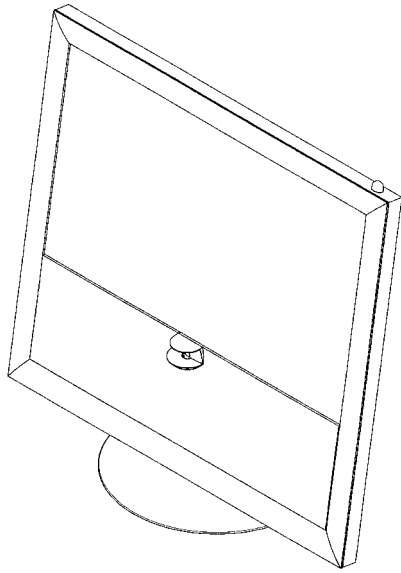

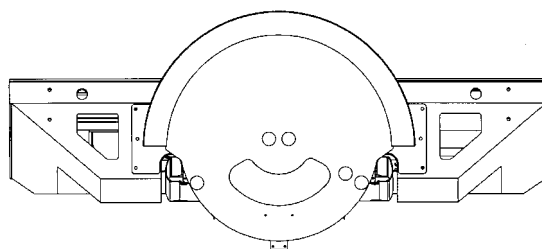
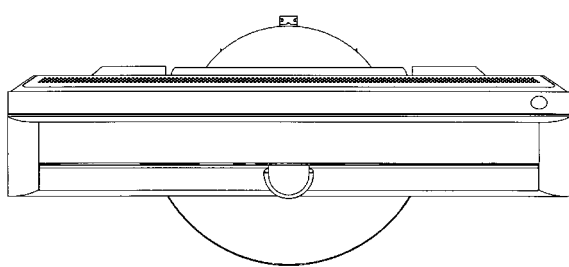
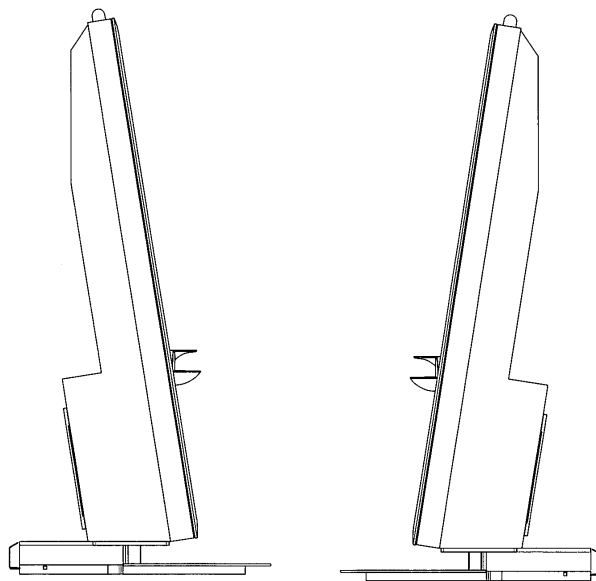

(71) ANSØGER(E):
(74) FULDMÆGTIG:
(72) FREMBRINGER(E):
(22) ANSØGNINGSDATO:
(18) GYLDIG TIL:

Bang & Olufsen A/S, Peter Bangsvej 15, 7600 Struer, Danmark
Sandel, Løje & Wallberg, Frederiksgade 7, 1265 København K, Danmark
David Lewis, Store Kongensgade 110C, 1264 København K, Danmark
2006-01-31
2011-01-31

(11) DR 2006 00212
 (21) DA 2006 00142

(54) 1) Et håndsat 2) trykknappområde til håndsat 3) frontdel til håndsat (51)-Cl.14 03

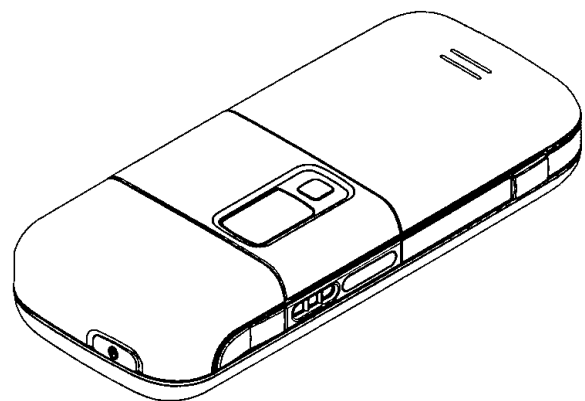
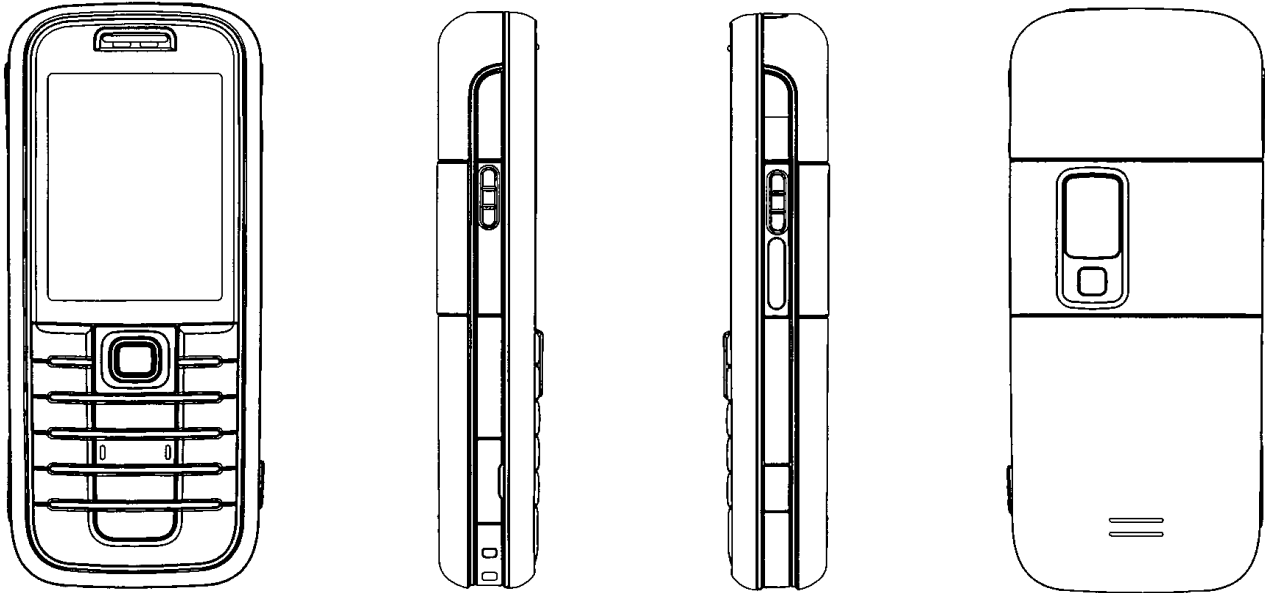

Løbenr. 1

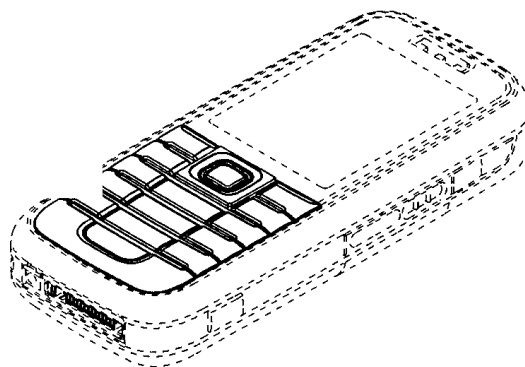
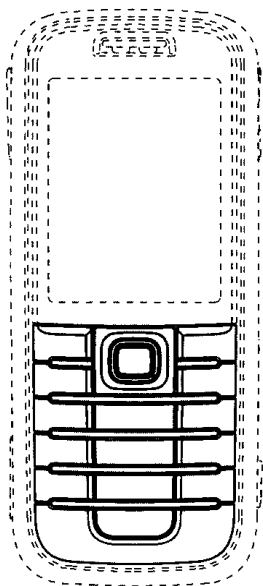

Løbenr. 2

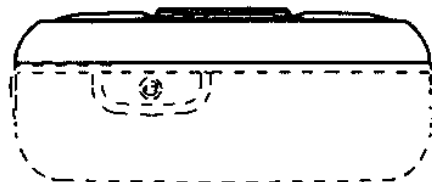
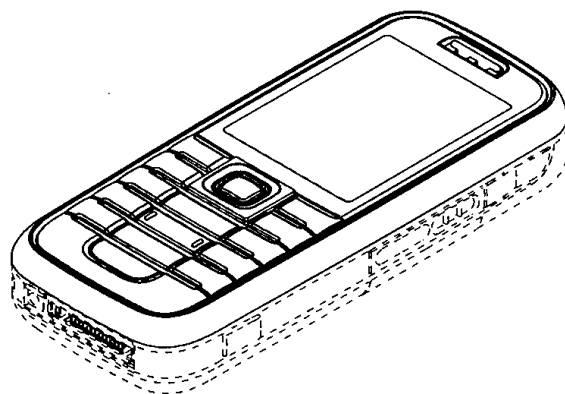
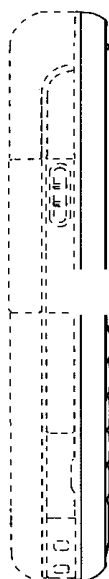
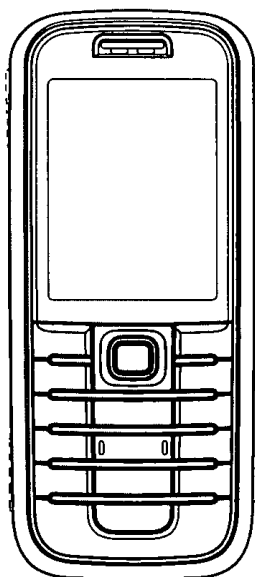

Løbenr. 3

(71) ANSØGER(E):
(74) FULDMÆGTIG:
(72) FREMBRINGER(E):

Nokia Corporation, Keilalahdentie 4, FI-02150 Espoo, Finland
Sandel, Løje & Wallberg, Frederiksgade 7, 1265 København K, Danmark
Edward Mitchell, Nørre Farimagsgade 1, 1.tv., 1364 København K, Danmark
Duncan Burns, #203 18645 Hatteras St., Tarzana, CA 91356, USA

(30) PRIORITET:
(22) ANSØGNINGSDATO:
(18) GYLDIG TIL:

2005-11-30 US 29/243708
2006-05-29
2011-05-29

(11) DR 2006 00213
(21) DA 2006 00143

(54) 1) Et håndsat 2) trykknapparrangement til håndsat 3) frontdel til håndsat (51)-Cl.14 03

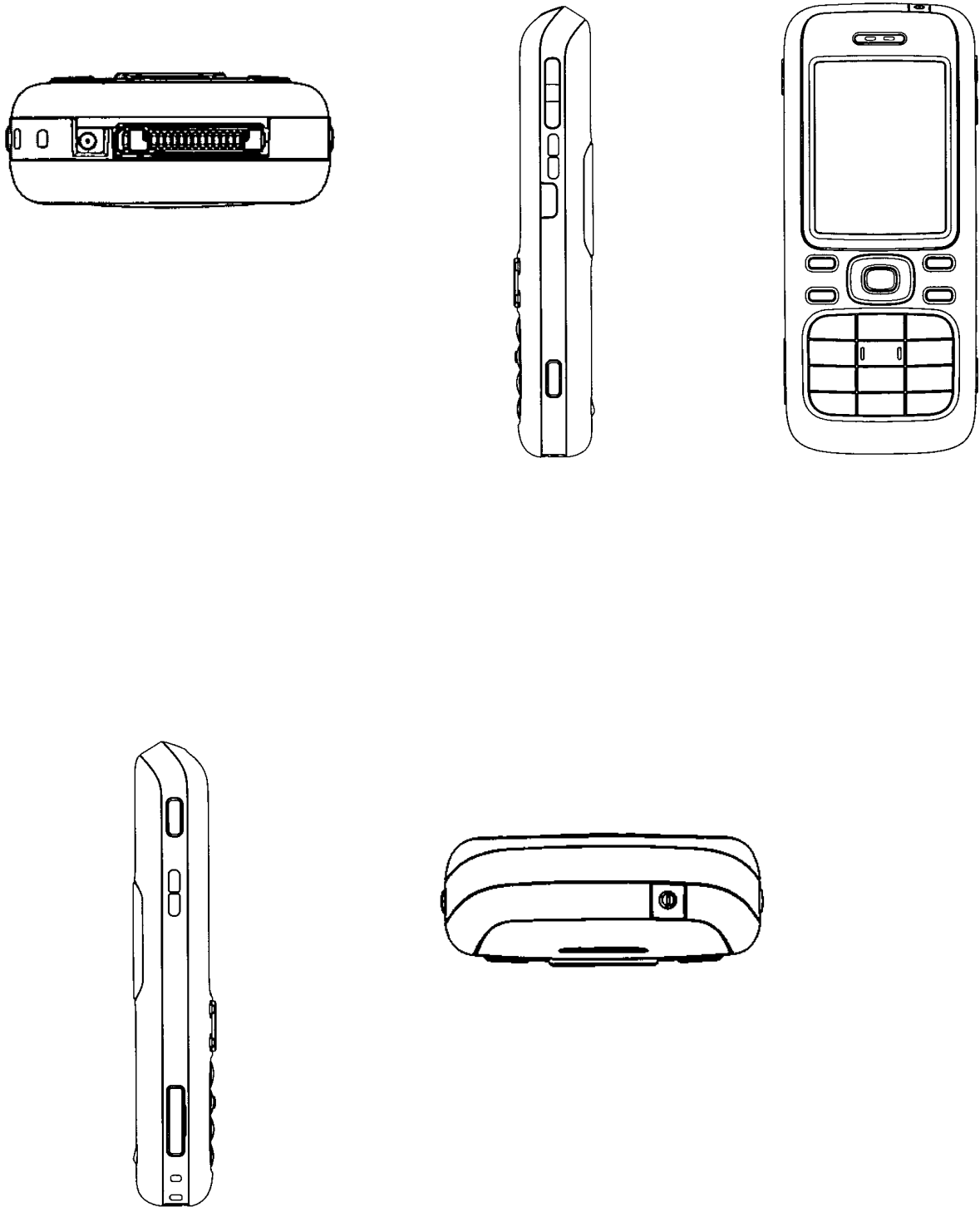

Løbenr. 1

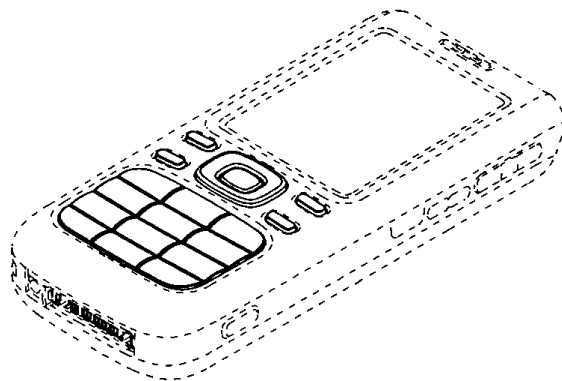
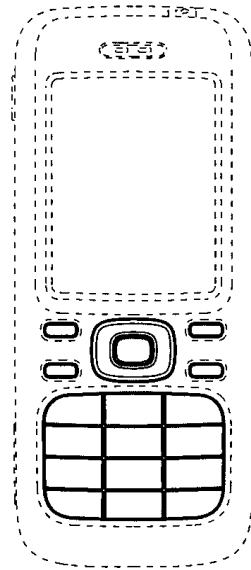
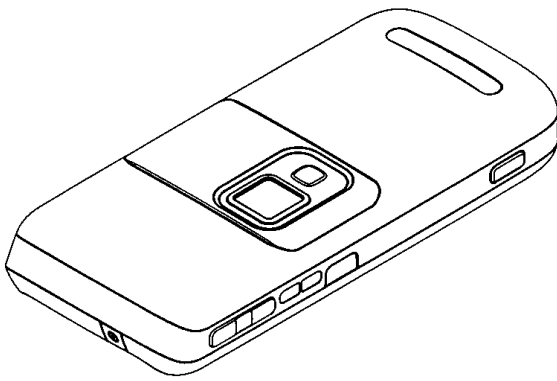
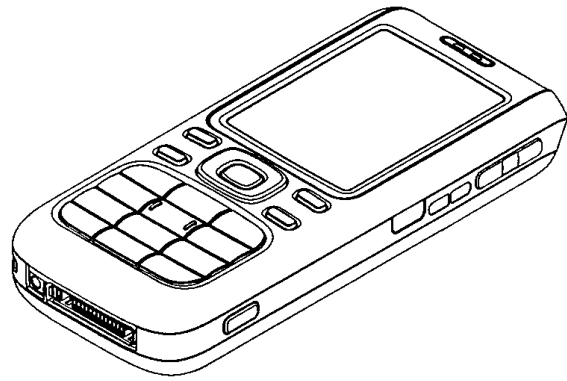
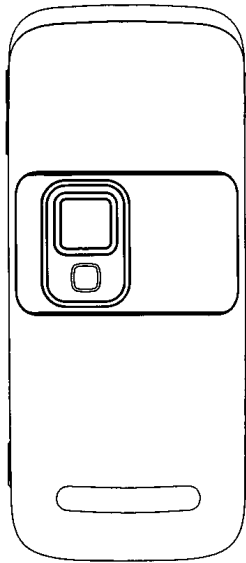

Løbenr. 2

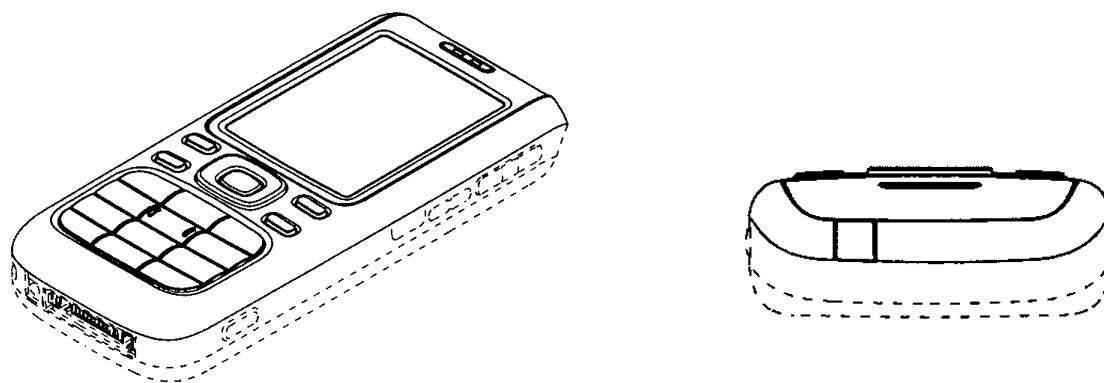
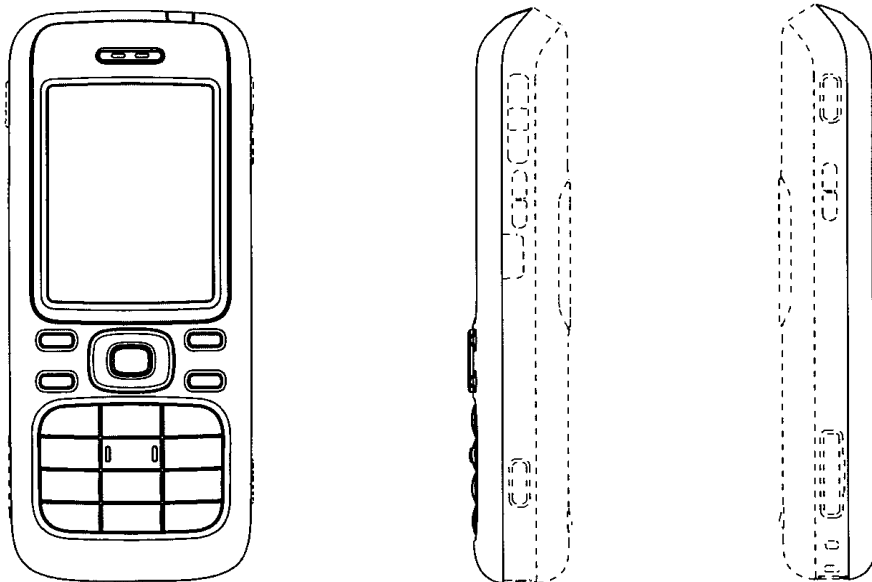

Løbenr. 3

(71) ANSØGER(E):
(74) FULDMÆGTIG:
(72) FREMBRINGER(E):

(30) PRIORITET:
(22) ANSØGNINGSDATO:
(18) GYLDIG TIL:

Nokia Corporation, Keilalahdentie 4, FI-02150 Espoo, Finland
Sandel, Løje & Wallberg, Frederiksgade 7, 1265 København K, Danmark
Wei-Jong Williams Sheu, 7852 Vicky Avenue, West Hills, CA 91304, USA
Duncan Burns, #203 18645 Hatteras St., Tarzana, CA 91356, USA
2005-11-30 US 29/243710
2006-05-29
2011-05-29

(11) DR 2006 00214
(21) DA 2006 00268

(54) En dørlukker

(51)-Cl.08 07

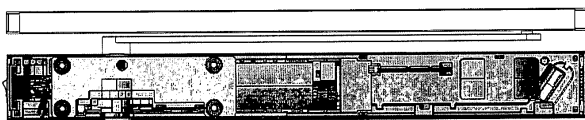
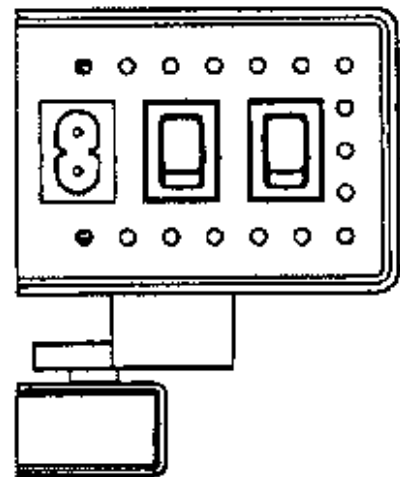
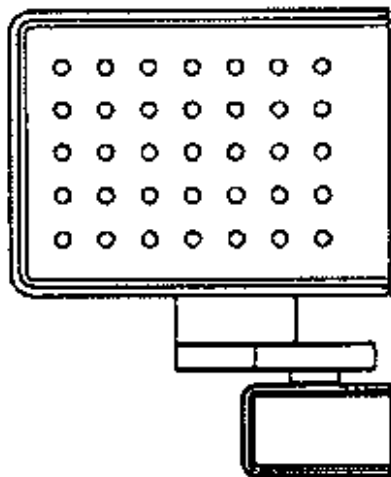
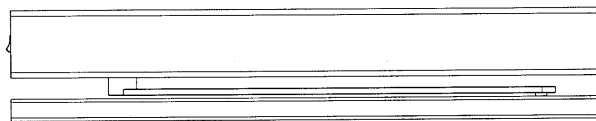
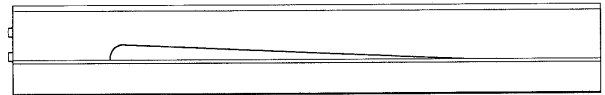
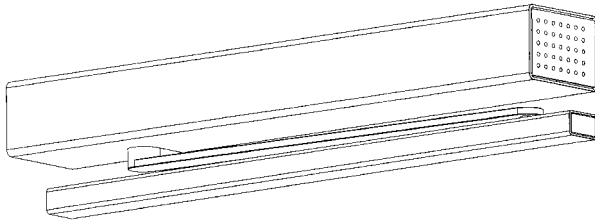

(71) ANSØGER(E):
(74) FULDMÆGTIG:
(30) PRIORITET:
(22) ANSØGNINGSDATO:
(18) GYLDIG TIL:

Dorma GmbH + Co. KG, Breckerfelder Strasse 42-48, D-58256 Ennepetal, Tyskland
Patrade A/S, Fredens Torv 3 A, 8000 Århus C, Danmark
2006-05-16 DE 406 02 750.1
2006-10-06
2011-10-06

(11) DR 2006 00215
 (21) DA 2006 00208

(54) 1) Et håndsat 2) trykknopområde til et håndsat 3) frontdel til et håndsat

(51)-Cl.14 03

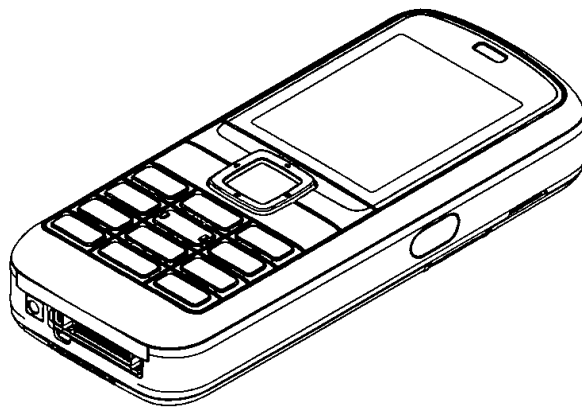
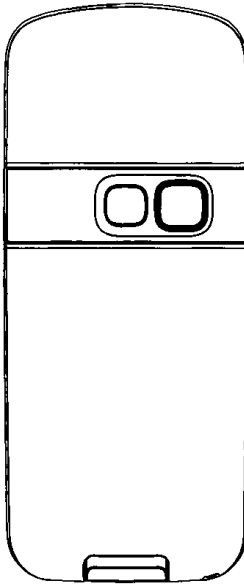
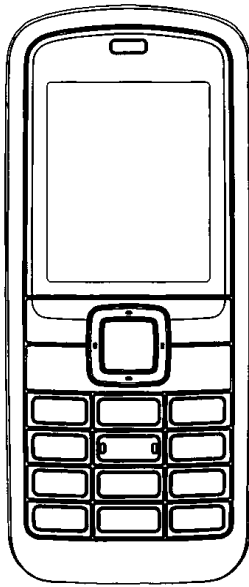

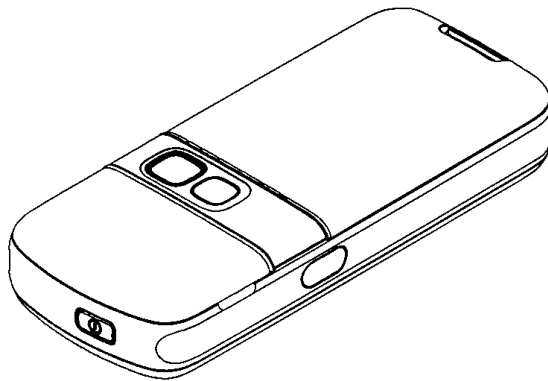
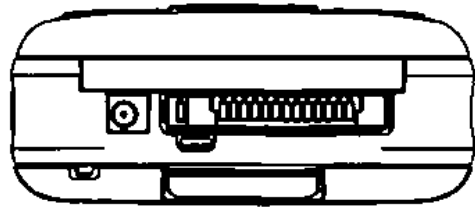
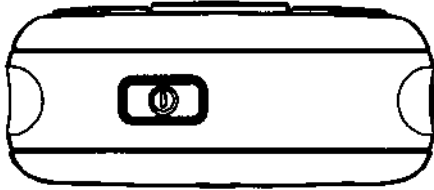

Løbenr. 1

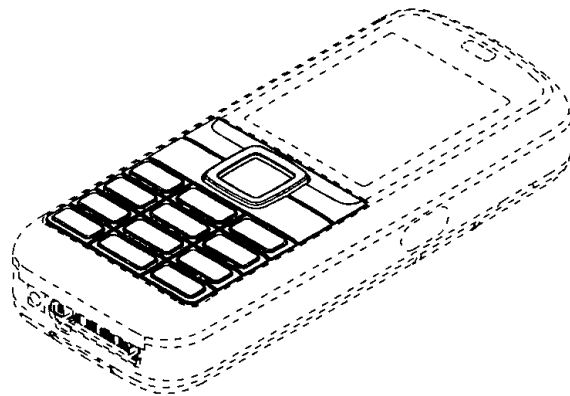
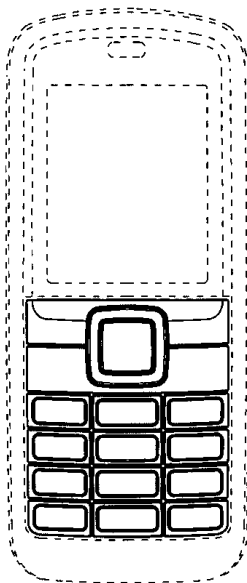

Løbenr. 2

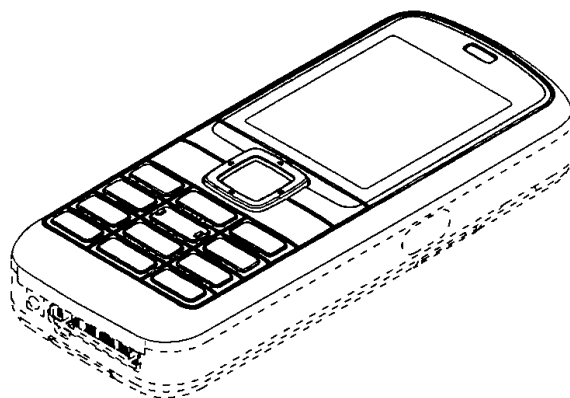
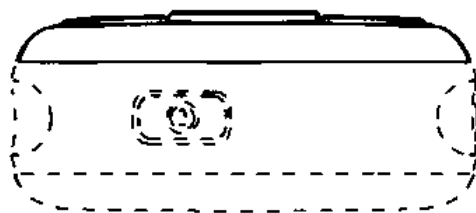
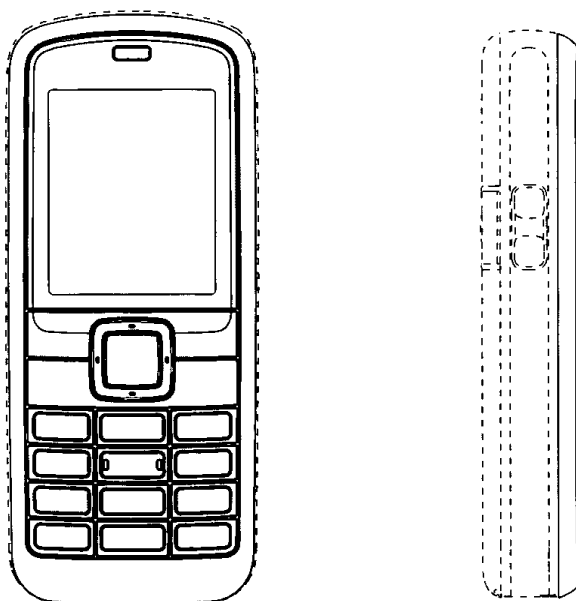

Løbenr. 3

(71) ANSØGER(E): Nokia Corporation, Keilalahdentie 4, FI-02150 Espoo, Finland
(74) FULDMÆGTIG: Sandel, Løje & Wallberg, Frederiksgade 7, 1265 København K, Danmark
(72) FREMBRINGER(E): John-Rhys Newman, 22044 Del Valle Street, Woodland Hills, CA 91364, USA
Jamie Cobb, 23 top floor flat, Stamford Road, London N1 4JP, Storbritannien
(30) PRIORITET: 2006-02-10 US 29/253.653
(22) ANSØGNINGSDATO: 2006-08-10
(18) GYLDIG TIL: 2011-08-10

(11) DR 2006 00216

(54) 1) Et håndsat 2) tastaturområde til et håndsat 3) frontdel af et håndsat
4) cover til et håndsat

(51)-Cl.14 03

(21) DA 2006 00227

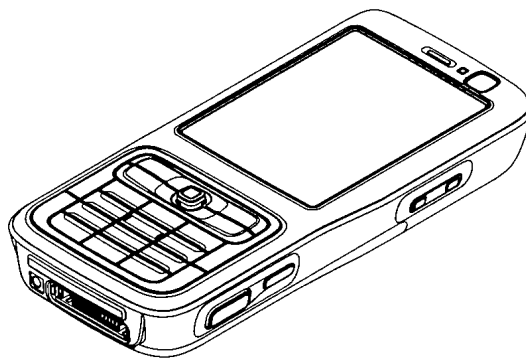
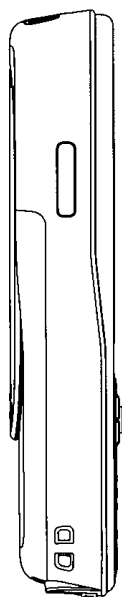
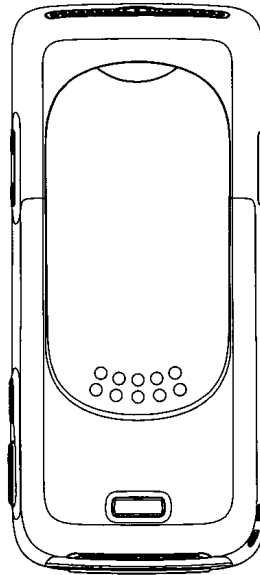
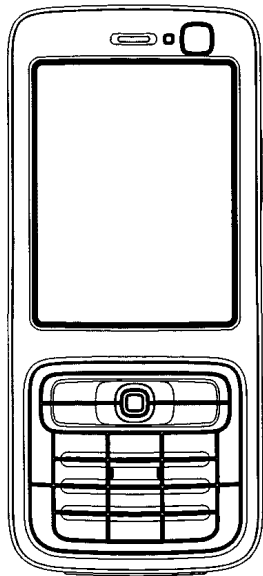

Løbenr. 1

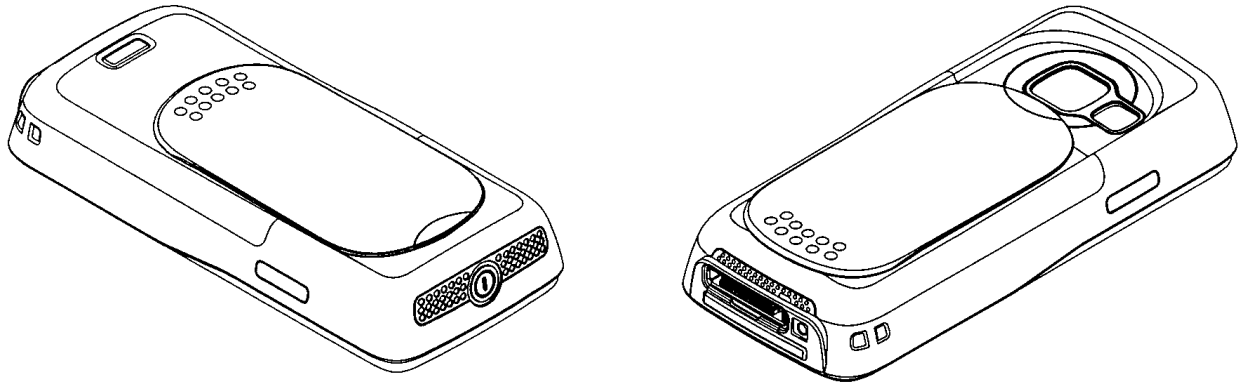

Løbenr. 2

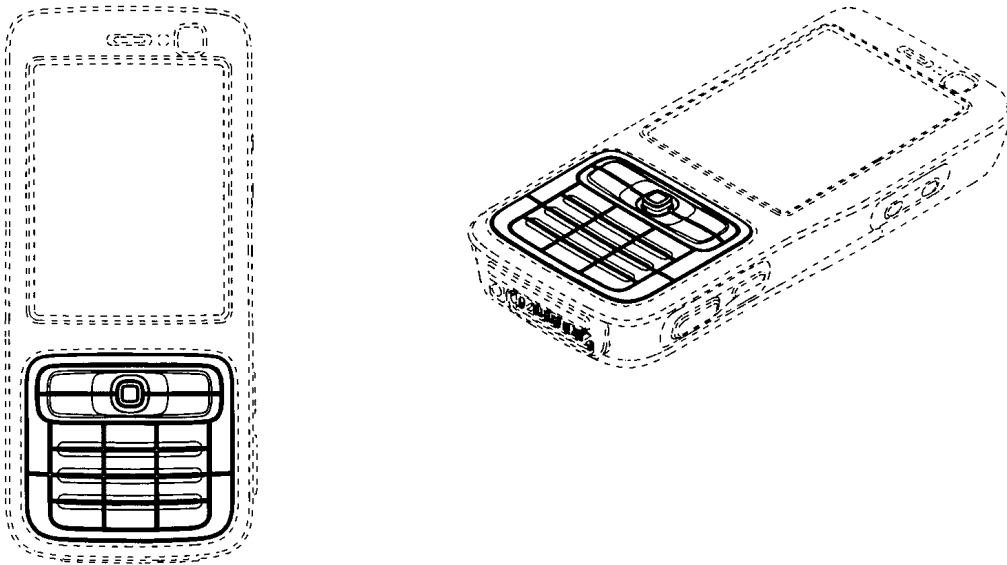

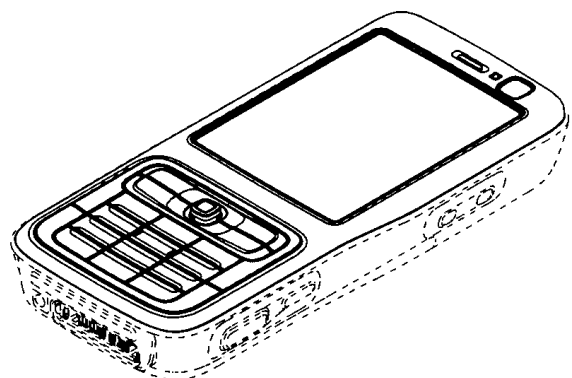
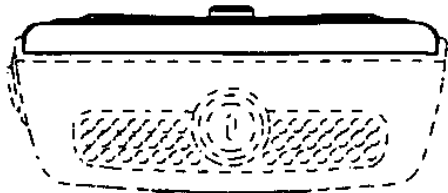
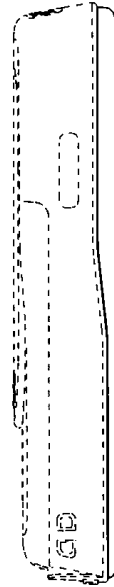
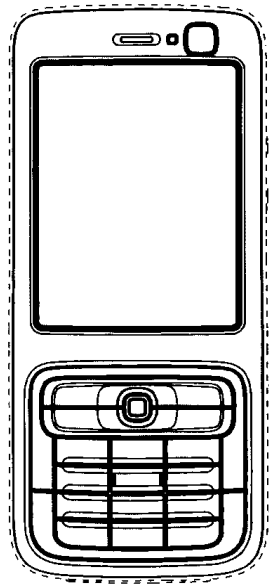

Løbenr. 3

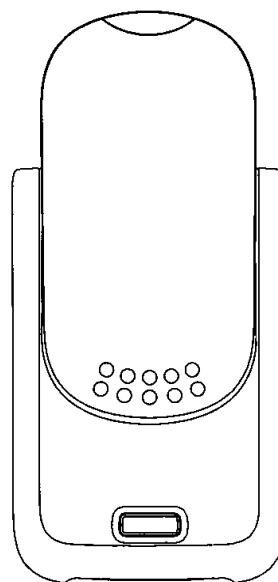
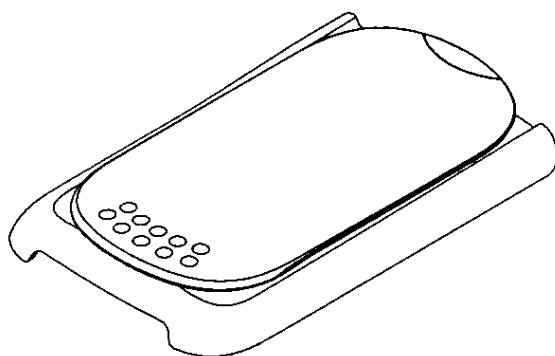
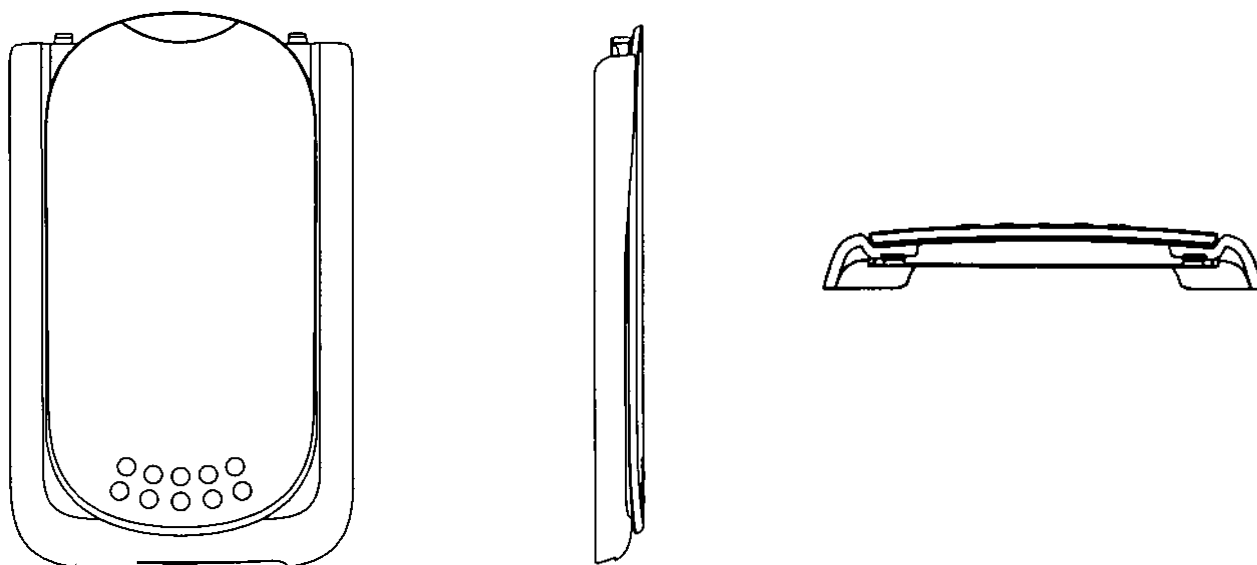

Løbenr. 4

(71) ANSØGER(E):	Nokia Corporation, Keilalahdentie 4, FI-02150 Espoo, Finland
(74) FULDMÆGTIG:	Sandel, Løje & Wallberg, Frederiksgade 7, 1265 København K, Danmark
(72) FREMBRINGER(E):	Luke Miles, 32 Hillcrest Road, Acton, London W39RY, Storbritannien Anthony Dalby, 30 Chandos Avenue, Ealing, London W5 4ER, Storbritannien
(30) PRIORITET:	2006-02-24 FI M20060043
(22) ANSØGNINGSDATO:	2006-08-23
(18) GYLDIG TIL:	2011-08-23

(11) DR 2006 00217
(21) DA 2006 00216

(54) En hængelampe

(51)-Cl.26 05

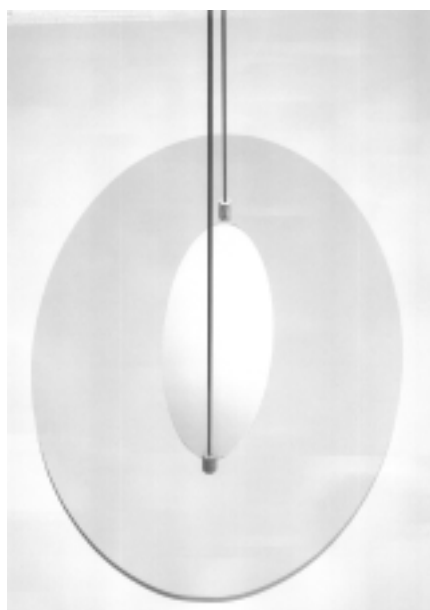

(71) ANSØGER(E):
(22) ANSØGNINGSDATO:
(18) GYLDIG TIL:

TL Lyngså A/S, c/o Torben Lausten, Østkystvejen 57, Lyngså, 9300 Sæby, Danmark
2006-08-12
2011-08-12

Ændringer

Ændringer vedrørende retten til designet, indehaverens navn/firma og adresse, fuldmægtig m.v.

Overdragelser:

(11) DR 2003 00407

Til: (71) Cartier Creation Studio SA, 8, Boulevard James-Fazy, Geneve, Schweiz

Fornyelse af designregistreringer

Fornyelse af registreringer foretaget i medfør af § 23, stk. 1, i designlov nr. 1259 af 20. december 2000.

(11) Registreringsnummer	(18) Gyldig til
DR 2002 00372	20111121
DR 2002 00146	20120117
DR 2002 00003	20111016
DR 2001 00025	20111024
DR 2001 00037	20111018
DR 2002 00253	20111020
DR 2001 00021	20111024
DR 2002 00387	20111221
DR 2002 00294	20111115
DR 2002 00295	20111115
DR 2001 00027	20111101
DR 2002 00146	20120117
DR 2002 00012	20111221
DR 2001 00035	20111023
DR 2001 00040	20111107
DR 2001 00041	20111107
DR 2002 00044	20111025
DR 2001 00045	20111121
DR 2001 00046	20111121
DR 2002 00466	20120128
DR 2002 00466	20120128

Udslettede registreringer

Udslettede registreringer foretaget i medfør af designlov nr. 1259 af 20. december 2000.

- (11) DR 2002 00015
- (11) DR 2002 00234
- (11) DR 2002 00241

Mønster

Ændringer

Ændringer vedrørende retten til mønstret, mønsterhavers navn, bopæl, fulm. m.v.

Overdragelser:

(11) MR 1996 00665

Til: (71) Cartier Creation Studio SA, 8, Boulevard James-Fazy, Geneve, Schweiz

(11) MR 1996 00666

Til: (71) Cartier Creation Studio SA, 8, Boulevard James-Fazy, Geneve, Schweiz

(11) MR 1996 00667

Til: (71) Cartier Creation Studio SA, 8, Boulevard James-Fazy, Geneve, Schweiz

(11) MR 1997 00819

Til: (71) Cartier Creation Studio SA, 8, Boulevard James-Fazy, Geneve, Schweiz

(11) MR 1998 00295

Til: (71) Cartier Creation Studio SA, 8, Boulevard James-Fazy, Geneve, Schweiz

(11) MR 1998 00428

Til: (71) Cartier Creation Studio SA, 8, Boulevard James-Fazy, Geneve, Schweiz

(11) MR 1999 00993

Til: (71) Cartier Creation Studio SA, 8, Boulevard James-Fazy, Geneve, Schweiz

(11) MR 2002 00259

Til: (71) Orthofix S.r.l., 9, Via delle Nazioni, 37012 Bussolengo - Verona, Italien

(11) MR 2002 00263

Til: (71) Orthofix S.r.l., 9, Via delle Nazioni, 37012 Bussolengo - Verona, Italien

(11) MR 2002 00264

Til: (71) Orthofix S.r.l., 9, Via delle Nazioni, 37012 Bussolengo - Verona, Italien

Fornyelse af mønsterregistreringer

Fornyelse af registreringer foretaget i medfør af lov om mønstre nr. 218 af 27. maj 1970.

(11) Registreringsnummer	(18) Gyldig til
MR 2002 00109	20110911
MR 1997 00440	20111104
MR 1997 00216	20111016
MR 1998 00091	20111015
MR 1997 00219	20111111
MR 1997 00220	20111111
MR 1997 00221	20111111
MR 1997 00222	20111111
MR 1997 00223	20111111
MR 1997 00699	20111202
MR 1997 00701	20111202
MR 1997 00700	20111202
MR 1997 00370	20111105

Udslettelser af registreringer

Udslettelser af registreringer foretaget i medfør af lov om mønstre nr. 218 af 27. maj 1970.

- (11) MR 1995 00902
- (11) MR 1997 00368
- (11) MR 1997 00610
- (11) MR 1997 00611
- (11) MR 2000 00888

WIPO Standard 80

INID-koder

Internationally agreed Numbers for the Identification of (bibliographic) data (INID)

- (11) Serial number of the registration
- (15) Date of the registration/Date of the renewal
- (17) Expected duration of the registration/
renewal
- (18) Expected expiration date of the registration/
renewal
- (21) Serial number of the application
- (22) Date of filing of the application
- (23) Name and place of exhibition, and date on
which the industrial design was first
exhibited there (Exhibition priority date)
- (24) Date from which the industrial design right
has effect
- (29) Indication of the form in which the industrial
design is filed, e.g. as a reproduction of the
industrial design or as a specimen thereof
- (30) Data relating to priority under the Paris
Convention
- (43) Date of publication of the industrial design
before examination
- (44) Date of publication of the industrial design
after examination but before registration
- (45) Date of publication of the registered
industrial design
- (46) Date of expiration of deferment
- (51) International Classification for Industrial
Designs (class and subclass of the Locarno
Classification)
- (54) Designation of article(s) or product(s)
covered by the industrial design or title of
the industrial design
- (55) Reproduction of the industrial design (e.g.,
drawing, photograph) and explanations
relating to the reproduction
- (57) Description of characteristic features of the
industrial design including indication of
colors
- (58) Date of recording of any kind of
amendment in the Register
- (62) Serial number(s) and, if available, filing
date(s) of application(s), registration(s) or
document(s) related by division
- (66) Serial number(s) of the application or the
registration of the design(s), which is(are) a
variant(s) of the present one
- (71) Name(s) and address(es) of the appli-
cant(s)
- (72) Name(s) of the creator(s) if known to be
such
- (73) Name(s) and address(es) of the owner(s)
- (74) Name(s) and address(es) of the
representative(s)

Domestic Codes for the Identification of Data

- (DL) Data concerning license
- (DP) Data concerning pawning

Internationalt vedtagne Numre til Identifikation af Data (INID)

Registreringsnummer
Registreringsdato/fornyelsesdato
Forventet registreringsperiode/fornyelsesperiode
Forventet udløbsdato for registrering/fornyelse

Ansøgningsnummer
Ansøgningsdato
Udstillingsnavn og -sted og dato for første udstil-
ling (udstillingsprioritetsoplysninger)

Indleveringsdato

Angivelse af i hvilken form designet er indleveret,
fx som en afbildning af designet eller som en
model heraf
Oplysninger om prioritet efter Pariserkonventionen

Dato for offentlig tilgængelighed

Bekendtgørelsesdato for ansøgningen

Offentliggørelse af registreringen

Udsættelsesdato
International klassifikation af design (klasser og
underklasser i Locarno Klassifikationen)

Vareangivelse/produktangivelse

Afbildninger af designet (fx tegninger, fotografier)
og forklaringer vedrørende afbildningerne

Beskrivelse af karakteristiske træk vedr. designet,
herunder angivelse af farver
Dato for tilførsel til registret

Nummer på hovedansøgning eller udskilt ansøg-
ning

Numre på beslægtede ansøgninger

Ansøgningsnavn og -adresse
Frembringers/designers navn og adresse
Indehavernavn og -adresse
Fuldmægtignavn og -adresse

Interne koder til identifikation af data

Licensoplysninger
Pantoplysninger
Oplysninger om konkurs